



PRODUCT CATALOG



PRODUCT CATALOG

- **Window Screens**
- **Patio Door Screens**
- **Components**

2024 TOTAL SCREEN SOLUTIONS

TABLE OF CONTENTS

Multiplier Sheet	1
Why Outsource?	2
Our Process	3
Plant Locations	4
Color Options	5
Screen Mesh Options	6

GENEXT SCREENS	
SH1	9
SH2	10
DH1	11
DH2	12
DH3	13
DH4	14
DH5	15
DH6	16
DH7	17
DH8	18
SL1	19
SL2	20
SL3	21
SL4	22
SL5	23
SL6	24
SL7	25
FS1	26
FS2	27
CA1	28
CA2	29
CA3	30
CA4	31
CA5	32
WK1	33
RS-505223	34
RS-505224	35

ROLL FORMED SCREENS	
RFSH1	39
RFSH2	40
RFSH3	41
RFSH4	42
RFSH5	43
RFSH6	44
RFSH7	45
RFSH8	46
RFSH9	47
RFDH1	48
RFDH2	49
RFDH3	50
RFDH4	51
RFDH5	52
RFDH6	53
RFDH7	54
RFSL1	55
RFSL2	56
RFSL3	57
RFFS1	58
RFFS2	59
RFCA1	60
RFCA2	61
RFCA3	62

PATIO DOOR SCREENS	
121S	65
199EXT	66
144EXT	67
MOOSE	68
121SMFIT	69
140SMFIT	70
MOOSEMFIT	71
Aluminum Patio Door Accessories	72
Single Swing Door	73
Double Swing Door	74

KITS & COMPONENTS	
Ultimate Multi-Fit Knock-Down Patio Door Kit	77
144EXT Knock-Down Kit	78
Customizable Distributor Knock-Down Kit	79
Screen Replacement Kits	80
Bug Strips, Caps, Clips, Crossbars	81
Corners	82
Handles, Latches	83
Leaf Springs, Pins, Plungers, Pull Tabs	84
Rivets, Rollers, Screen Frames	85
Screen Frames	86
Screen Mesh	87
Spline, Springs, Strikes, Wool Pile	88
Trim Coil	89

Multiplier Sheet

Company Name	
Sold To Number	
Effective Date	
Name	
Address	
Phone	
Email	

RiteScreen Sales Director Approval		Customer Approval	
Name		Name	
Signature		Signature	
Date		Date	

Window Screens							
Extruded Screens				Roll-Formed Screens			
Series	Screen Multiplier	Option Multiplier	Color Multiplier	Series	Screen Multiplier	Option Multiplier	Color Multiplier
SH1				RFSH1			
SH2				RFSH2			
DH1				RFSH3			
DH2				RFSH4			
DH3				RFSH5			
DH4				RFSH6			
DH5				RFSH7			
DH6				RFSH8			
DH7				RFSH9			
DH8				RFDH1			
SL1				RFDH2			
SL2				RFDH3			
SL3				RFDH4			
SL4				RFDH5			
SL5				RFDH6			
SL6				RFDH7			
FS1				RFSL1			
FS2				RFSL2			
CA1				RFSL3			
CA2				RFFS1			
CA3				RFFS2			
CA4				RFCA1			
CA5				RFCA2			
WK1				RFCA3			
RS-505223							
RS-505224							

Patio Door Screens				
Series	Door Multiplier	Roller Multiplier	Option Multiplier	Color Multiplier
12IS				
199EXT				
144EXT				
MOOSE				
SINGLE SWING				
DOUBLE SWING				

Multi-Fit Patio Door				
Series	Door Multiplier	Roller Multiplier	Option Multiplier	Color Multiplier
12ISMFIT				
140SMFIT				
MOOSEMFIT				

Components	
All	

Packaging		
Type	UI List Price	Multiplier
WS - Plastic Wrapped (1-20)	\$1.60	
WS - Cardboard Wrapped (1-20)	\$23.52	
WS - Shipping Box	\$114.24	
PDS - Plastic Wrapped	\$9.36	
PDS - Cardboard Wrapped	\$30.72	
PDS - Shipping Box	\$134.24	

Color Options	
Colors	List Price
Wood-wrap	\$352.00
Customer Specific Color*	\$10.00
Custom Colors	\$90.00
Post Fabricated Painted Screens	\$261.90
Minimum of 10,000 / per year / per color	



RITESCREEN

WHY OUTSOURCE?

With our extensive experience and screen manufacturing capabilities, RiteScreen is the company you can trust when you decide to outsource.

WHY DO MANUFACTURERS OUTSOURCE SCREENS?

- Frees floor space
- Allows businesses to focus capital on core window and door manufacturing
- Redeploys scarce labor to what you do best - building windows and doors
- Eliminates inventory and maintenance
- Availability of proven outsourced options and services
- Substantial cost reduction with no change to window design
- Emergence of sophisticated EDI, Sequencing, and JIT Programs



**EVERY TOP
TEN WINDOW
MANUFACTURER
IN THE U.S.
OUTSOURCES
SCREENS**

OUTSOURCING TO SAVE

Higher quality at a lower cost. When you outsource with RiteScreen, you get the benefit of screens that represent the best in the industry, while reducing your production costs significantly. Our commitment to lean manufacturing and production can improve nearly every aspect of your business.

We can meet your supply chain needs to any quantity or specification. Additionally, with our uninterrupted production and delivery from manufacturing facilities across the United States, your products will be delivered on time, every time.



**FASTER,
BETTER
BUSINESS.**

OUR PROCESS

- 1** The RiteScreen Team comes to your facility, performing a comprehensive review of your products, manufacturing processes, and a needs analysis. We offer recommendations on how you can achieve the greatest cost savings.
- 2** Our R&D department goes to work, continuing to collaborate with your team each step of the way to ensure the design provides the best possible value and that your screens will be the perfect fit for the specific products that your produce.
- 3** RiteScreen continues consulting with you on your new processes and products. When you decide to outsource, our team of expert fabricators will get to work producing screens using the designs we developed with your team.
- 4** RiteScreen offers custom-engineered packaging options. Your screens will be delivered from one of our seven strategically located manufacturing facilities to ensure on-time delivery.

OUR PRODUCTS

ASSEMBLED WINDOW SCREEN SOLUTIONS

Durable, versatile, and aesthetically pleasing, RiteScreen produces window screens designed for both ease of use and long-term performance.

ASSEMBLED DOOR SCREEN SOLUTIONS

Roll-formed steel or aluminum and extruded aluminum door screens that feature superior performance and high-quality weatherstripping.

SCREEN COMPONENTS

Our full line of frames, corners and hardware for both window screens and door screens helps RiteScreen provide a total screen solution to our customers.

ENGINEERED SOLUTIONS

Our engineers lead the industry with innovative solutions to any screening need, with technology to give any manufacturer the competitive edge.



With over 75 years of experience and seven locations across the country, you can trust RiteScreen to meet all of your screening needs.

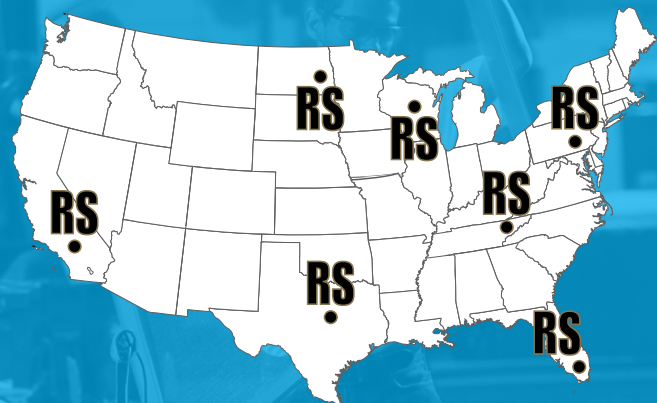

CONTACT US:
(800) 949-4174
RITESCREEN.COM
INSIDESALES@RITESCREEN.COM



RITESCREEN

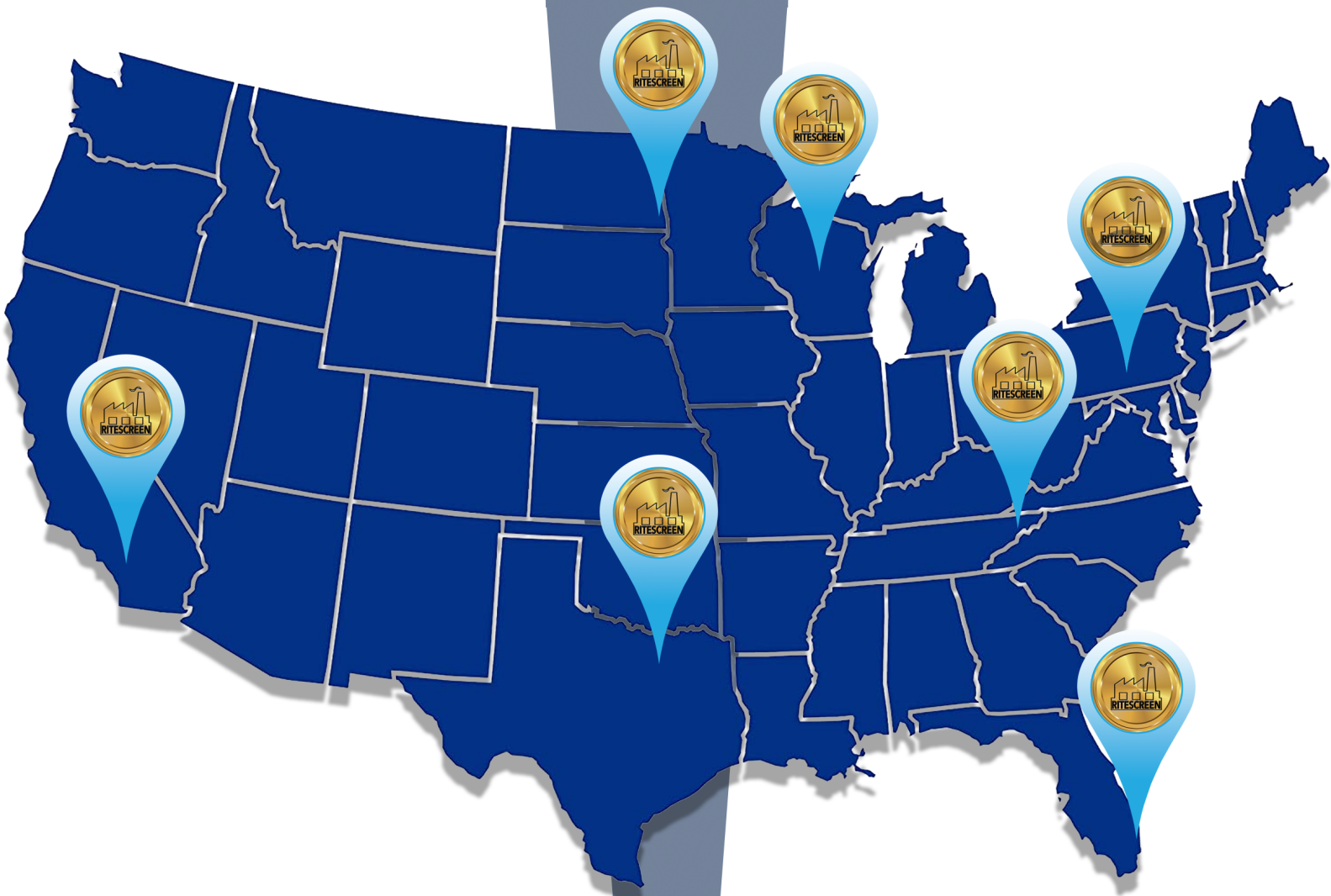

PLANT LOCATIONS

Elizabethville, PA (Corporate Office)

Van Alstyne, TX

Elizabethton, TN

Fargo, ND

Merrill, WI

Hialeah, FL

Rancho Cucamonga, CA

insidesales@ritescreen.com | www.ritescreen.com | 800-949-4174

COLOR SELECTION

Standard Colors: Each of the screens in this catalog is available in RiteScreen's Standard Colors for no additional cost.

Standard Colors:

XXX in part numbers are
place holders for Color Code



Additional Colors: Additional colors are available for customers with specific color needs for an upcharge.

PACKAGING OPTIONS

RiteScreen offers the following packaging options. Please contact sales director for pricing and specific details on Patio Door Screen packaging.

PLASTIC WRAPPED



Window Screen (1-20) - \$1.60
Patio Door Screen - \$9.36
(Shipping box not included in price, see below)

CARDBOARD WRAPPED



Window Screen (1-20) - \$23.52
Patio Door Screen - \$30.72
(Shipping box not included in price, see below)

SHIPPING BOX



Window Screen - \$114.25
Patio Door Screen - \$134.24



BetterVue® +0.0640 UI

BetterVue® insect screening with Water Shed Technology™ preserves optical clarity by shedding water and resisting dirt and grime for a sharp, more brilliant outward view.



UltraVue® +0.1200 UI

If you're looking for an insect screening that will block the pests but not the view, then UltraVue® excellent visibility (eVis) screening is for you.

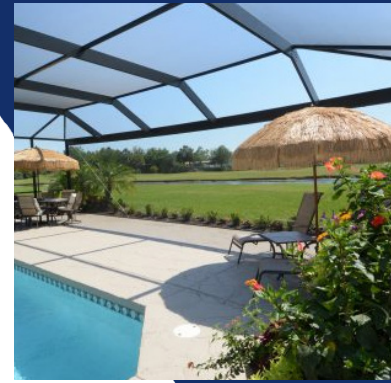

Tuff-Screen® +0.2300 UI

Looking for a reliable insect screen that's built to last? Tuff-Screen No-See-Ums is made from durable mesh and keeps small insects out.



Solar Screen +0.3440 UI

Learn more about SunScreen, the original woven solar screen fabric. SunScreen stops insects and blocks up to 70% of the sun's heat.

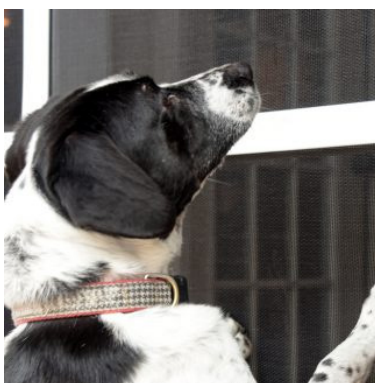

PetScreen® +0.2460 UI

Looking for an insect screen that will keep bugs out but withstand the wear and tear from your dog or cat? PetScreen is the perfect choice for you!

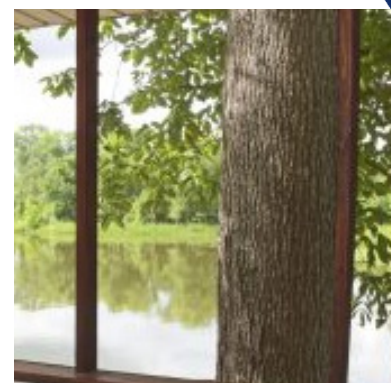

Standard Aluminum +0.1120 UI

Looking for a reliable insect screen that sets the standard for quality? Our standard aluminum insect screen provides insect protection along with increased visibility.

Part #	Description	Square Feet	List Price
MSFG18X100-L00	18" x 100' Char Fiber Mesh	150	\$92.40
MSFG20X100-L00	20" x 100' Char Fiber Mesh	166.67	\$102.67
MSFG24X100-L00	24" x 100' Char Fiber Mesh	200	\$123.20
MSFG28X100-L00	28" x 100' Char Fiber Mesh	233.33	\$143.73
MSFG32X100-L00	32" x 100' Char Fiber Mesh	266.67	\$164.27
MSFG35X100-L00	35" x 100' Char Fiber Mesh	291.67	\$179.67
MSFG36X100-L00	36" x 100' Char Fiber Mesh	300	\$184.80
MSFG40X100-L00	40" x 100' Char Fiber Mesh	333.33	\$205.33
MSFG48X100-L00	48" x 100' Char Fiber Mesh	400	\$246.40

Insect screens will not stop a child from falling out of a window. Keep child away from open/unlocked window.



GENEXT WINDOW SCREENS

A woman is sitting on a bed, looking out a window. The window has a white GenExt window screen. The view outside the window is a bright, sunny day with a clear blue sky and a lush green landscape. The bed has a dark wood headboard and a light-colored, textured pillow. The overall scene is bright and airy, suggesting a comfortable and durable living environment.

**Our GenExt window screens
are durable and guaranteed to last!**

SH1 - Single Hung Top Springs

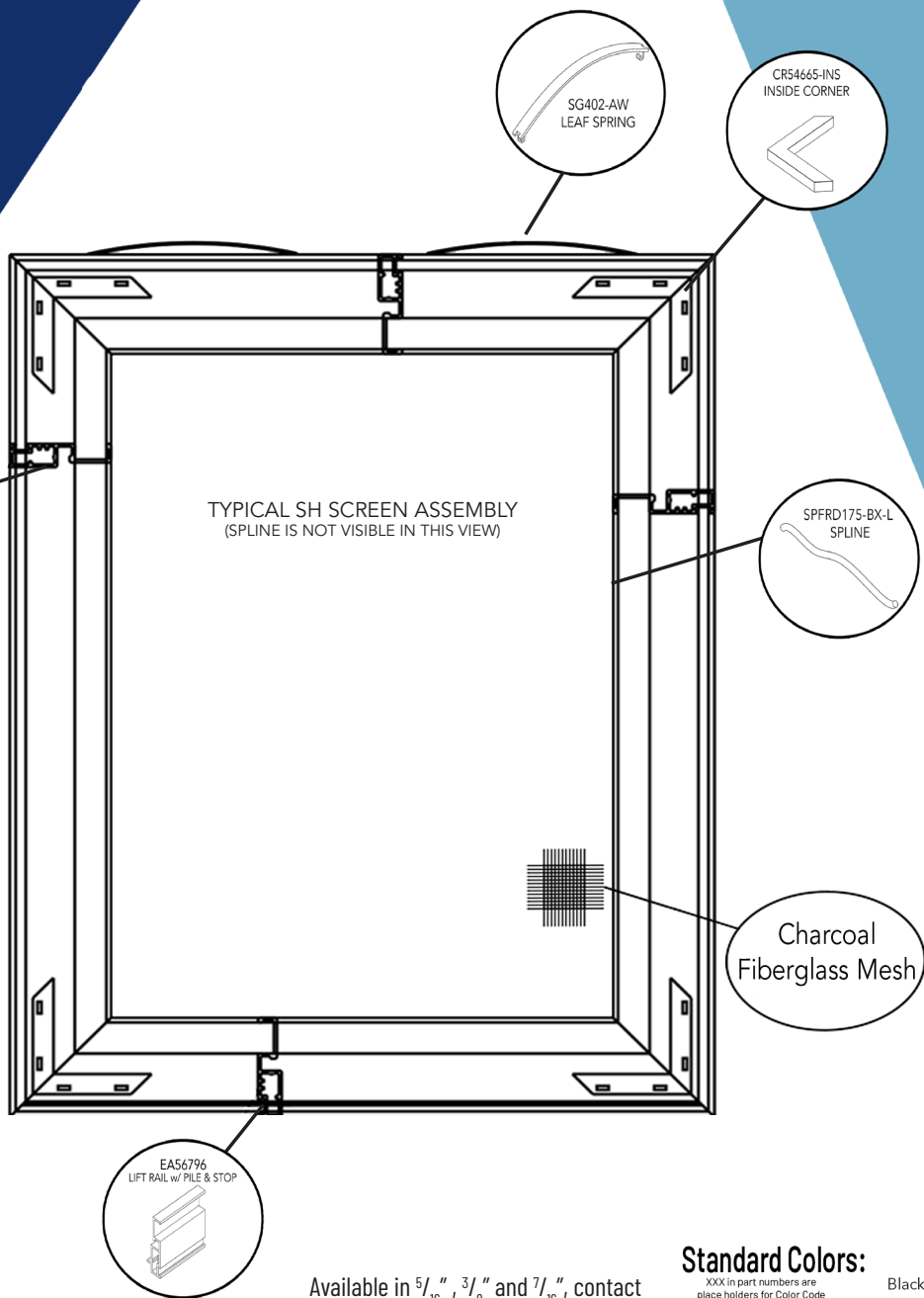
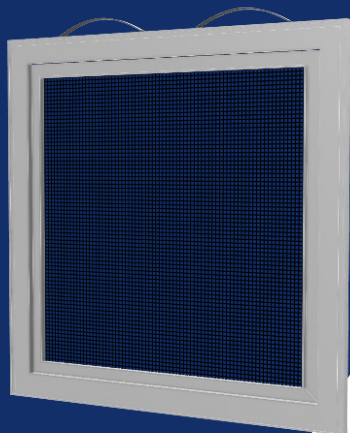

Available in $\frac{5}{16}$ " , $\frac{3}{8}$ " and $\frac{7}{16}$ " , contact RiteScreen for details.

Standard Colors:



Series #	Fully Assembled Screen	Size	UOM	List Price
SH1	Minimum Price	0" to 49" UI	United Inch	\$43.30
SH1	U.I. Price	50" UI and Above	United Inch	\$0.8838

Part #	Description	Color	Length	UOM	QTY	List Price
EA56801-150-XXX	Lift Rail w/Pile	Standard	12.5'	Box	20/pcs	\$821.04
EA56796-150-XXX	Lift Rail w/Pile and Stop	Standard	12.5'	Box	20/pcs	\$851.62
XCR54665-INS**	Inside Corner	Mill		Box	100/pcs	\$100.66
XSG402-AW**	Leaf Spring	Mill		Box	100/pcs	\$83.06
MSFG36X100-L00	36" x 100' Char Fiber Mesh	Charcoal	100'	Roll	400 ft ²	\$184.80
SPFRD175-BX-L	.175" Diameter Foam Spline	Black	5,000'	Box	5,000'	\$483.00

**Available in bulk quantities

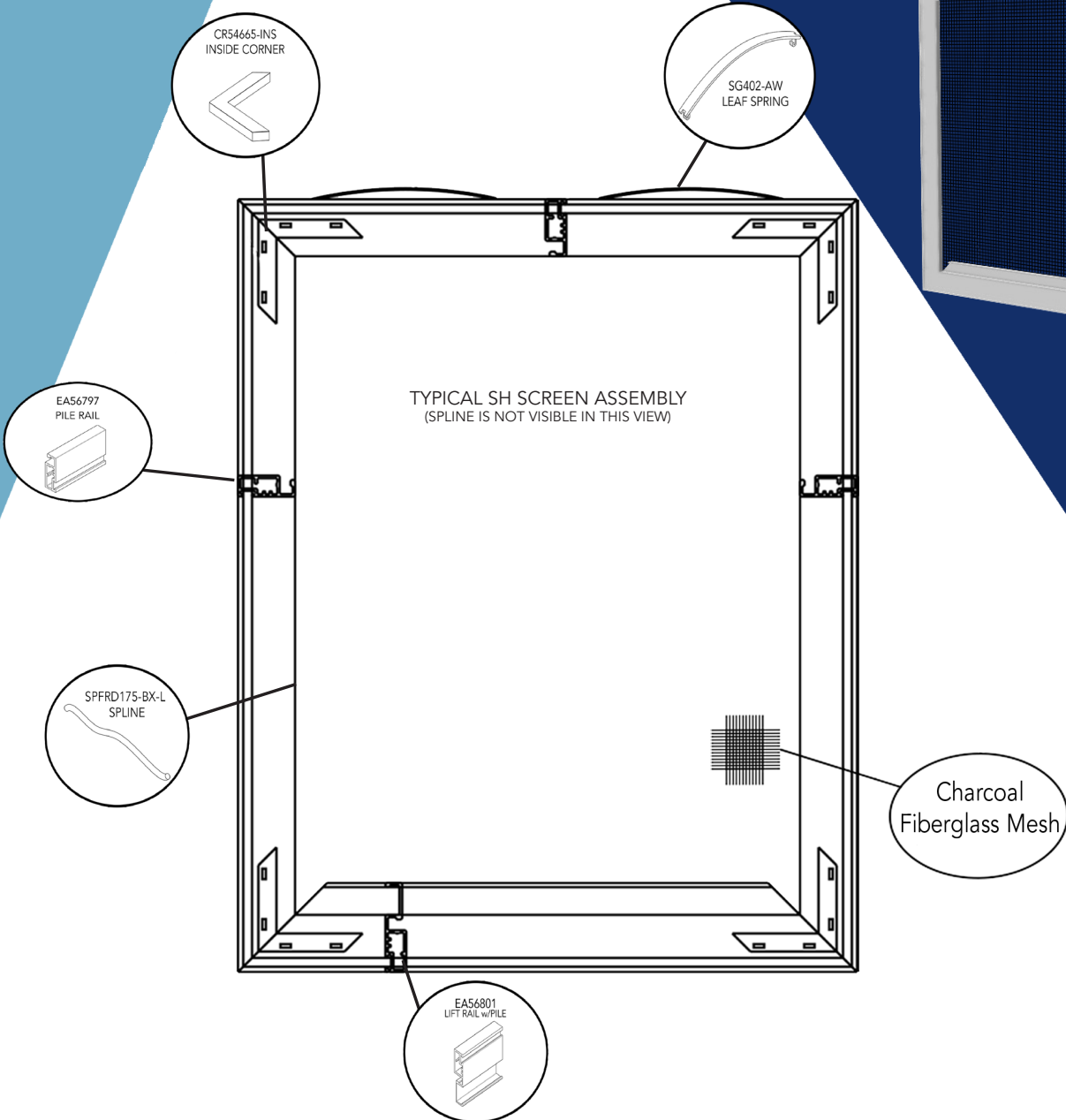

Standard Colors:

XXX in part numbers are place holders for Color Code

White (C01)

Black (L48)

Clay (A22)

Almond (A29)

Bronze (B16)

Available in $\frac{5}{16}$ " , $\frac{3}{8}$ " and $\frac{7}{16}$ " , contact RiteScreen for details.

Series #	Fully Assembled Screen	Size	UOM	List Price
SH2	Minimum Price	0" to 49" UI	United Inch	\$38.86
SH2	U.I. Price	50" UI and Above	United Inch	\$0.7930

Part #	Description	Color	Length	UOM	QTY	List Price
EA56801-150-XXX	Lift Rail w/Pile	Standard	12.5'	Box	20/pcs	\$821.04
EA56797-150-XXX	Pile Rail	Standard	12.5'	Box	20/pcs	\$658.24
XCR54665-INS**	Inside Corner	Mill		Box	100/pcs	\$100.66
XSG402-AW**	Leaf Spring	Mill		Box	100/pcs	\$83.06
MSFG36X100-L00	36" x 100' Char Fiber Mesh	Charcoal	100'	Roll	400 ft ²	\$184.80
SPFRD175-BX-L	.175" Diameter Foam Spline	Black	5,000'	Box	5,000'	\$483.00

** Available in bulk quantities

DH1 - Double Hung Half Screen

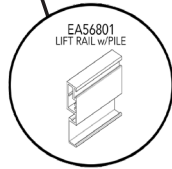
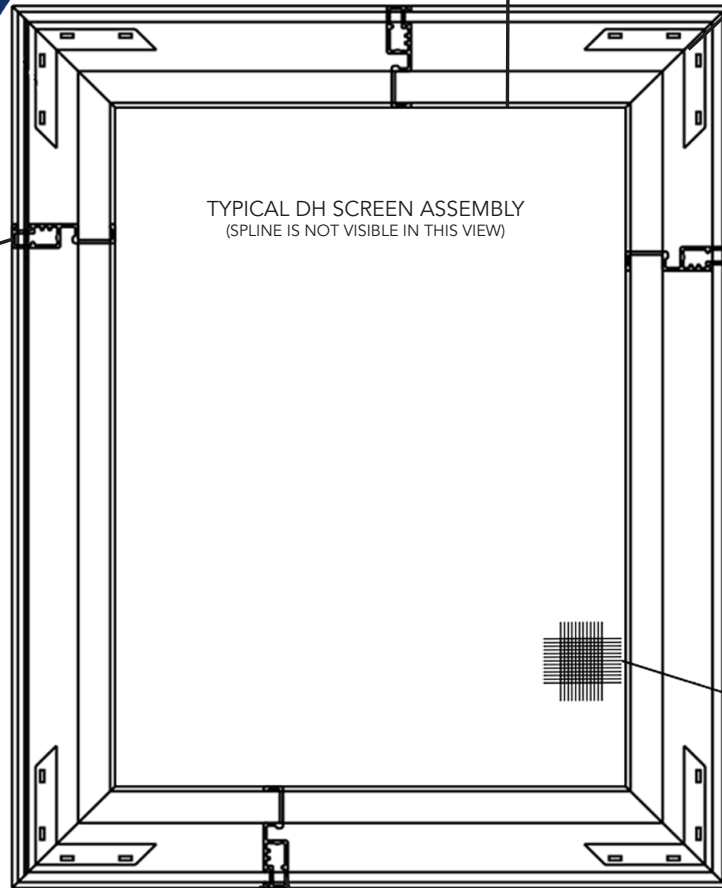
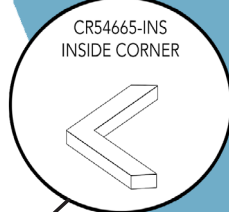
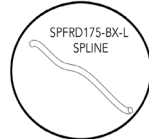
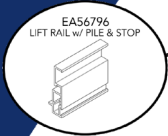
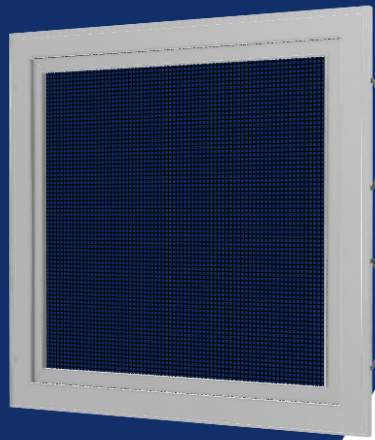

Available in $\frac{5}{16}$ " , $\frac{3}{8}$ " and $\frac{7}{16}$ " , contact RiteScreen for details.

Standard Colors:

XXX in part numbers are place holders for Color Code

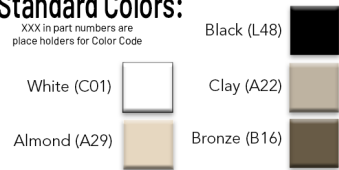

Series #	Fully Assembled Screen	Size	UOM	List Price
DH1	Minimum Price	0" to 49" UI	United Inch	\$41.12
DH1	U.I. Price	50" UI and Above	United Inch	\$0.8390

Part #	Description	Color	Length	UOM	QTY	List Price
EA56801-150-XXX	Lift Rail w/Pile	Standard	12.5'	Box	20/pcs	\$821.04
EA56796-150-XXX	Lift Rail w/Pile and Stop	Standard	12.5'	Box	20/pcs	\$851.62
XCR54665-INS**	Inside Corner	Mill		Box	100/pcs	\$100.66
XSG402-AW**	Leaf Spring	Mill		Box	100/pcs	\$83.06
MSFG36X100-L00	36" x 100' Char Fiber Mesh	Charcoal	100'	Roll	400 ft ²	\$184.80
SPFRD175-BX-L	.175" Diameter Foam Spline	Black	5,000'	Box	5,000'	\$483.00

**Available in bulk quantities

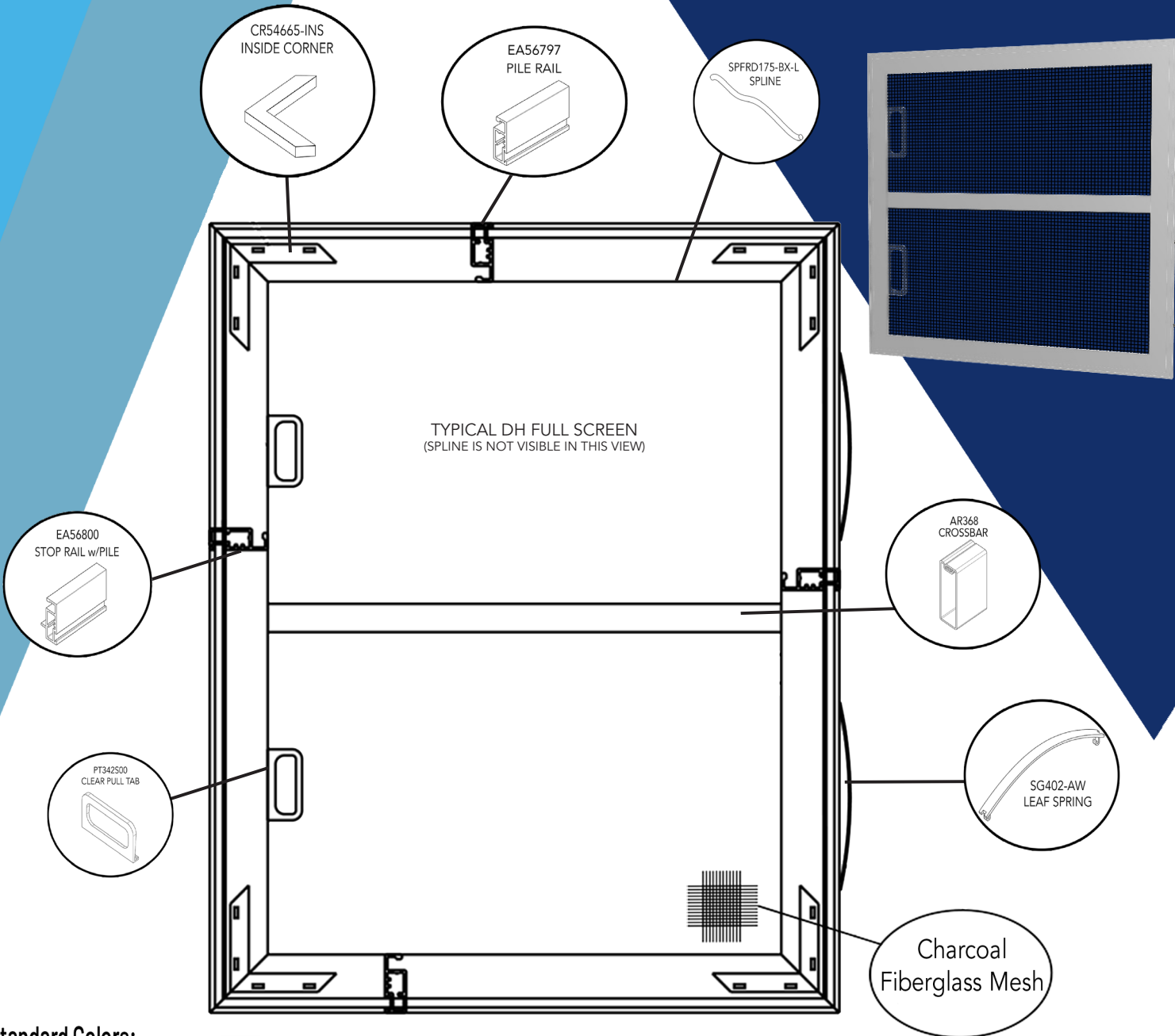

Standard Colors:

XXX in part numbers are
placeholders for Color Code

Black (L48)	
White (C01)	
Almond (A29)	
Clay (A22)	
Bronze (B16)	

Available in $\frac{5}{16}$ " , $\frac{3}{8}$ " and $\frac{7}{16}$ " , contact
RiteScreen for details.

Series #	Fully Assembled Screen	Size	UOM	List Price
DH2	Minimum Price	0" to 49" UI	United Inch	\$35.02
DH2	U.I. Price	50" UI and Above	United Inch	\$0.7146

Part #	Description	Color	Length	UOM	QTY	List Price
EA56797-150-XXX	Pile Rail	Standard	12.5'	Box	20/pcs	\$658.24
EA56800-150-XXX	Stop Rail w/Pile	Standard	12.5'	Box	20/pcs	\$658.90
AR368-16-12XXX	Crossbar	Standard	12.5'	Box	152/pcs	\$1,583.36
XCR54665-INS**	Inside Corner	Mill		Box	100/pcs	\$100.66
XPT342S00**	Clear Pull Tab	Clear		Box	100/pcs	\$78.74
XSG402-AW**	Leaf Spring	Mill		Box	100/pcs	\$83.06
MSFG36X100-L00	36" x 100' Char Fiber Mesh	Charcoal	100'	Roll	400 ft ²	\$184.80
SPFRD175-BX-L	.175" Diameter Foam Spline	Black	5,000'	Box	5,000'	\$483.00

**Available in bulk quantities

DH3 - Double Hung Half Latching Screen

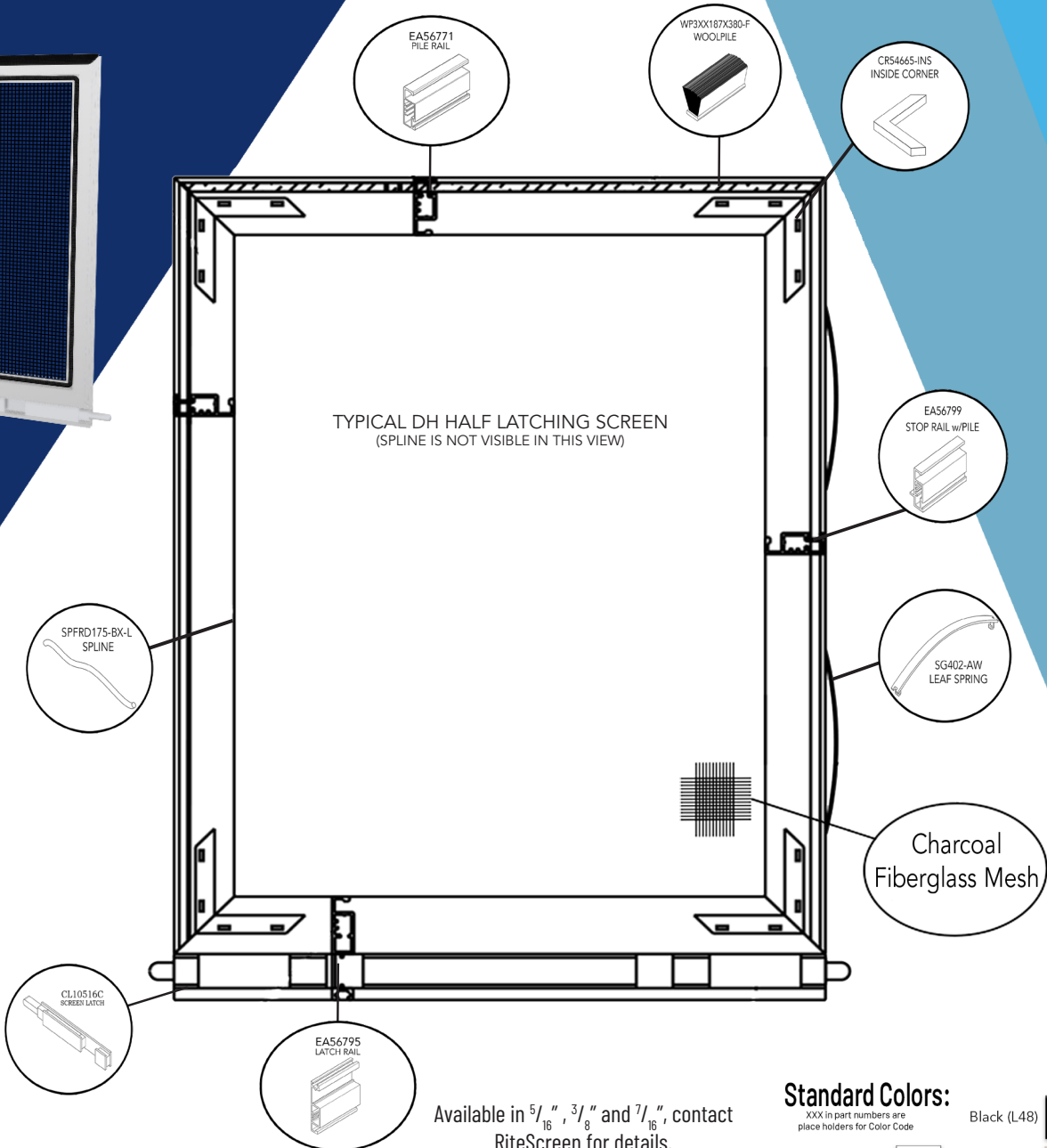
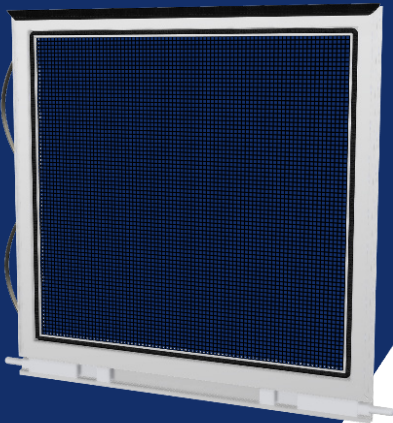

Available in $\frac{5}{16}$ " , $\frac{3}{8}$ " and $\frac{7}{16}$ " , contact RiteScreen for details.

Standard Colors:

XXX in part numbers are place holders for Color Code

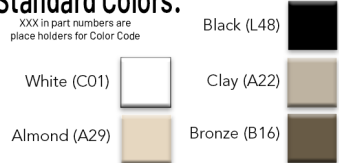

Series #	Fully Assembled Screen	Size	UOM	List Price
DH3	Minimum Price	0" to 49" UI	United Inch	\$48.52
DH3	U.I. Price	50" UI and Above	United Inch	\$0.9904



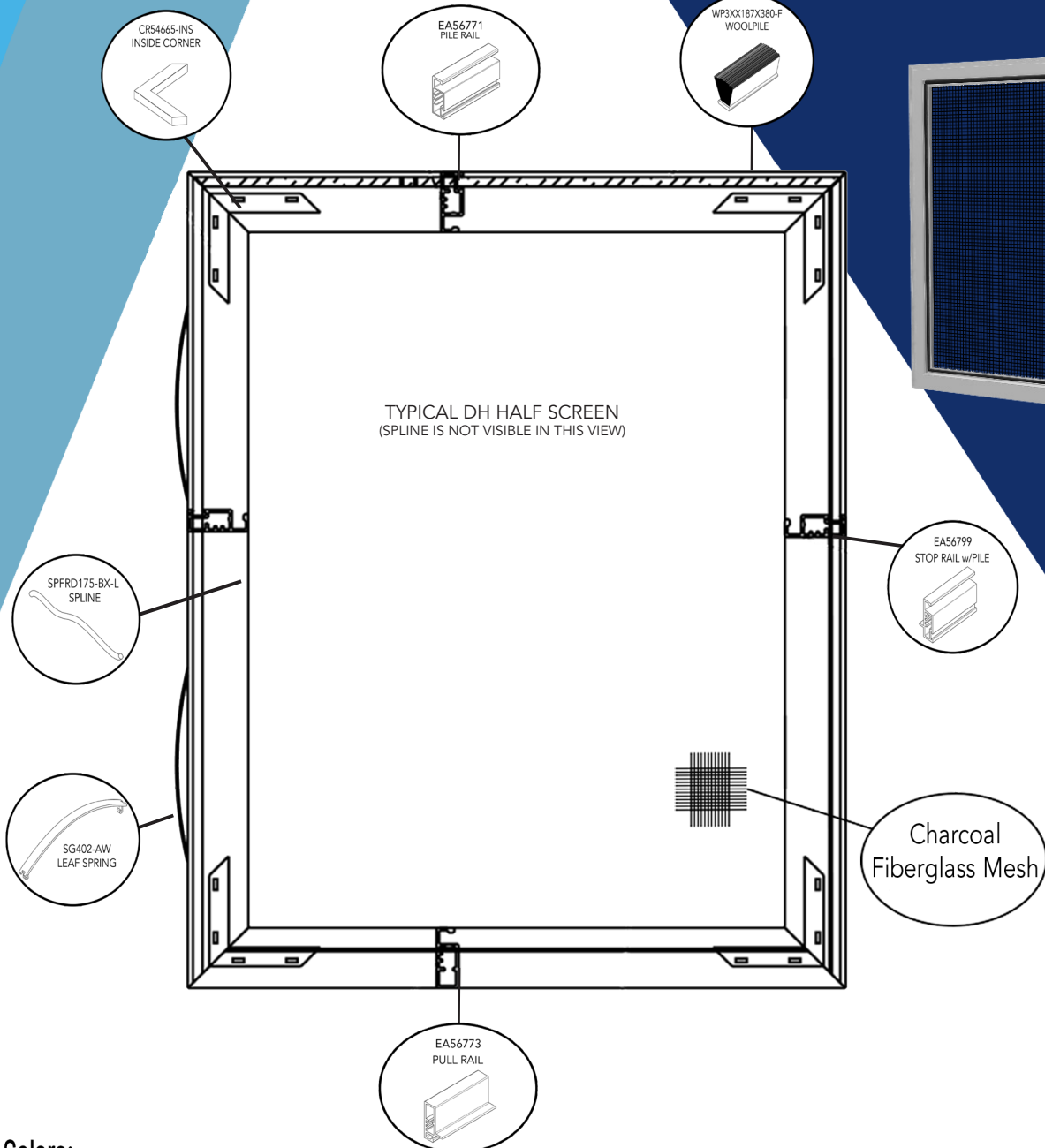

Part #	Description	Color	Length	UOM	QTY	List Price
EA56771-150-XXX	Pile Rail	Standard	12.5'	Box	20/pcs	\$734.14
EA56799-150-XXX	Stop Rail w/Pile	Standard	12.5'	Box	20/pcs	\$777.92
EA56795-150-XXX	Latch Rail	Standard	12.5'	Box	20/pcs	\$991.54
XSG10497**	Spring & Dog Assembly (not shown)	Mill		Box	100/pcs	\$119.32
XCL10516C**	Screen Latch	Standard		Box	100/pcs	\$167.72
XCR54665-INS**	Inside Corner	Mill		Box	100/pcs	\$100.66
XSG402-AW**	Leaf Spring	Mill		Box	100/pcs	\$83.06
WP3XX187X380-F	.380" High Pile	Standard	4,000 ft.	Box	4,000 ft.	\$1,680.00
MSFG36X100-L00	36" x 100' Char Fiber Mesh	Charcoal	100'	Roll	400 ft ²	\$184.80
SPFRD175-BX-L	.175" Diameter Foam Spline	Black	5,000'	Box	5,000'	\$483.00

**Available in bulk quantities



Standard Colors:

XXX in part numbers are
place holders for Color Code

Black (L48)	
White (C01)	
Almond (A29)	
Clay (A22)	
Bronze (B16)	

Available in $\frac{5}{16}$ " , $\frac{3}{8}$ " and $\frac{7}{16}$ " contact
RiteScreen for details.

Series #	Fully Assembled Screen	Size	UOM	List Price
DH4	Minimum Price	0" to 49" UI	United Inch	\$37.22
DH4	U.I. Price	50" UI and Above	United Inch	\$0.7598

Part #	Description	Color	Length	UOM	QTY	List Price
EA56771-150-XXX	Pile Rail	Standard	12.5'	Box	20/pcs	\$734.14
EA56799-150-XXX	Stop Rail w/Pile	Standard	12.5'	Box	20/pcs	\$777.92
EA56773-150-XXX	Pull Rail	Standard	12.5'	Box	20/pcs	\$559.24
XCR54665-INS**	Inside Corner	Mill		Box	100/pcs	\$100.66
XSG402-AW**	Leaf Spring	Mill		Box	100/pcs	\$83.06
WP3XX187X380-F	.380" High Pile	Standard	4,000 ft.	Box	4,000 ft.	\$1,680.00
MSFG36X100-L00	36" x 100' Char Fiber Mesh	Charcoal	100'	Roll	400 ft ²	\$184.80
SPFRD175-BX-L	.175" Diameter Foam Spline	Black	5,000'	Box	5,000'	\$483.00

**Available in bulk quantities

DH5 - Double Hung Flanged Full Screen

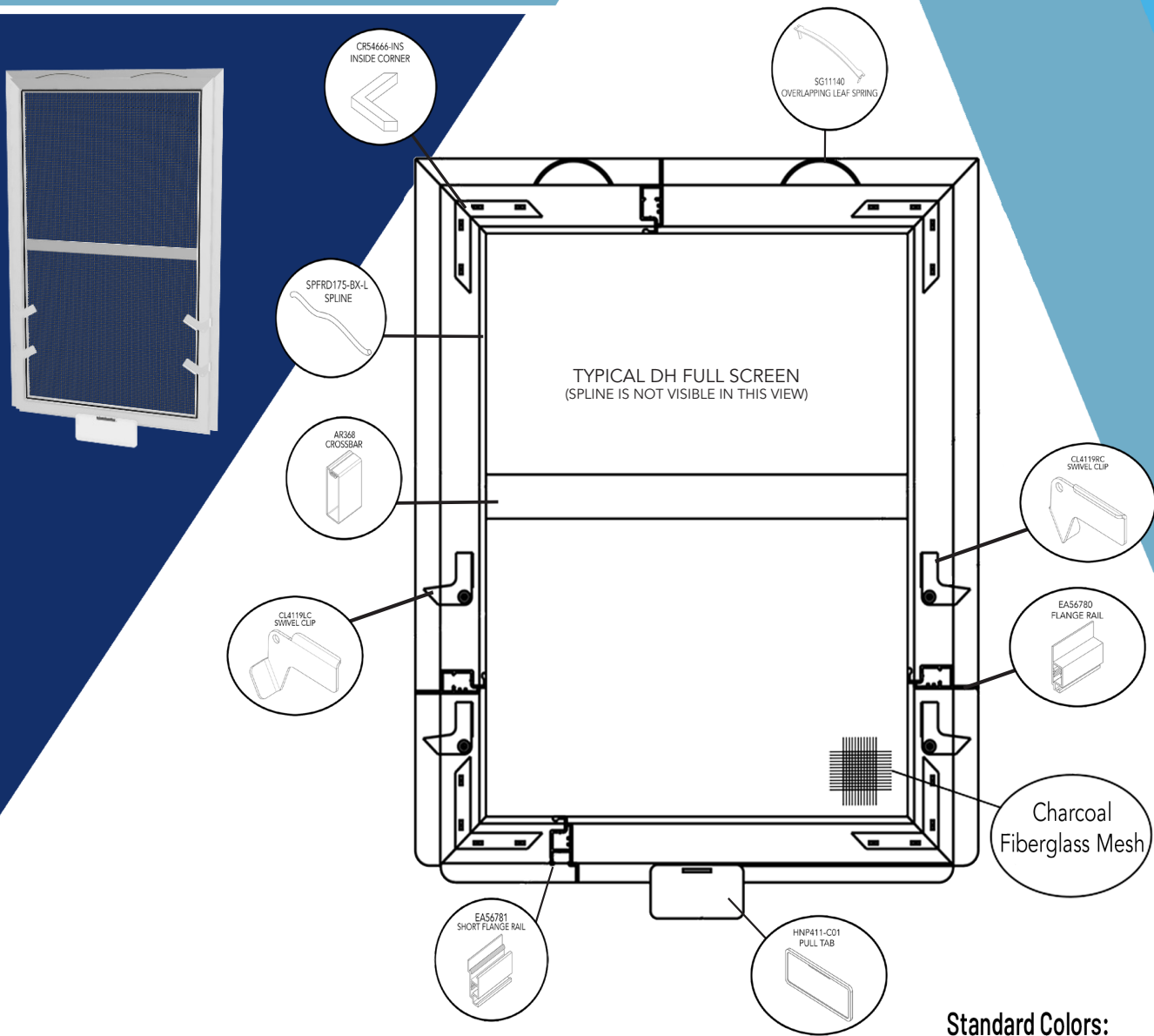

Shown in $\frac{3}{8}$ "

Standard Colors:

XXX in part numbers are place holders for Color Code

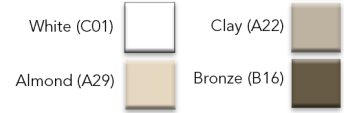

Series #	Fully Assembled Screen	Size	UOM	List Price
DH5	Minimum Price	0" to 49" UI	United Inch	\$52.18
DH5	U.I. Price	50" UI and Above	United Inch	\$1.0648

Part #	Description	Color	Length	UOM	QTY	List Price
EA56780-150-XXX	Flange Rail	Standard	12.5'	Box	20/pcs	\$878.02
EA56781-150-XXX	Short Flange Rail	Standard	12.5'	Box	20/pcs	\$779.68
AR368-16-12XXX	Crossbar	Standard	12.5'	Box	152/pcs	\$1,583.36
XCR54666-INS**	Inside Corner	Mill		Box	100/pcs	\$124.94
XCL4119LC**	Swivel Clip (Left)	White		Box	100/pcs	\$150.60
XCL4119RC**	Swivel Clip (Right)	White		Box	100/pcs	\$150.60
XFS527**	Rivet (Not shown)	Mill		Box	100/pcs	\$72.58
XHNP411-XXX**	Pull Tab	White or Black		Box	100/pcs	\$297.60
XCL12337**	Metal Clip (Pull Tab) (Not shown)	Mill		Box	100/pcs	\$195.52
XSG11140**	Overlapping Leaf Spring	Mill		Box	100/pcs	\$113.94
MSFG36X100-L00	36" x 100' Char Fiber Mesh	Charcoal	100'	Roll	400 ft ²	\$184.80
SPFRD175-BX-L	.175" Diameter Foam Spline	Black	5,000'	Box	5,000'	\$483.00

**Available in bulk quantities

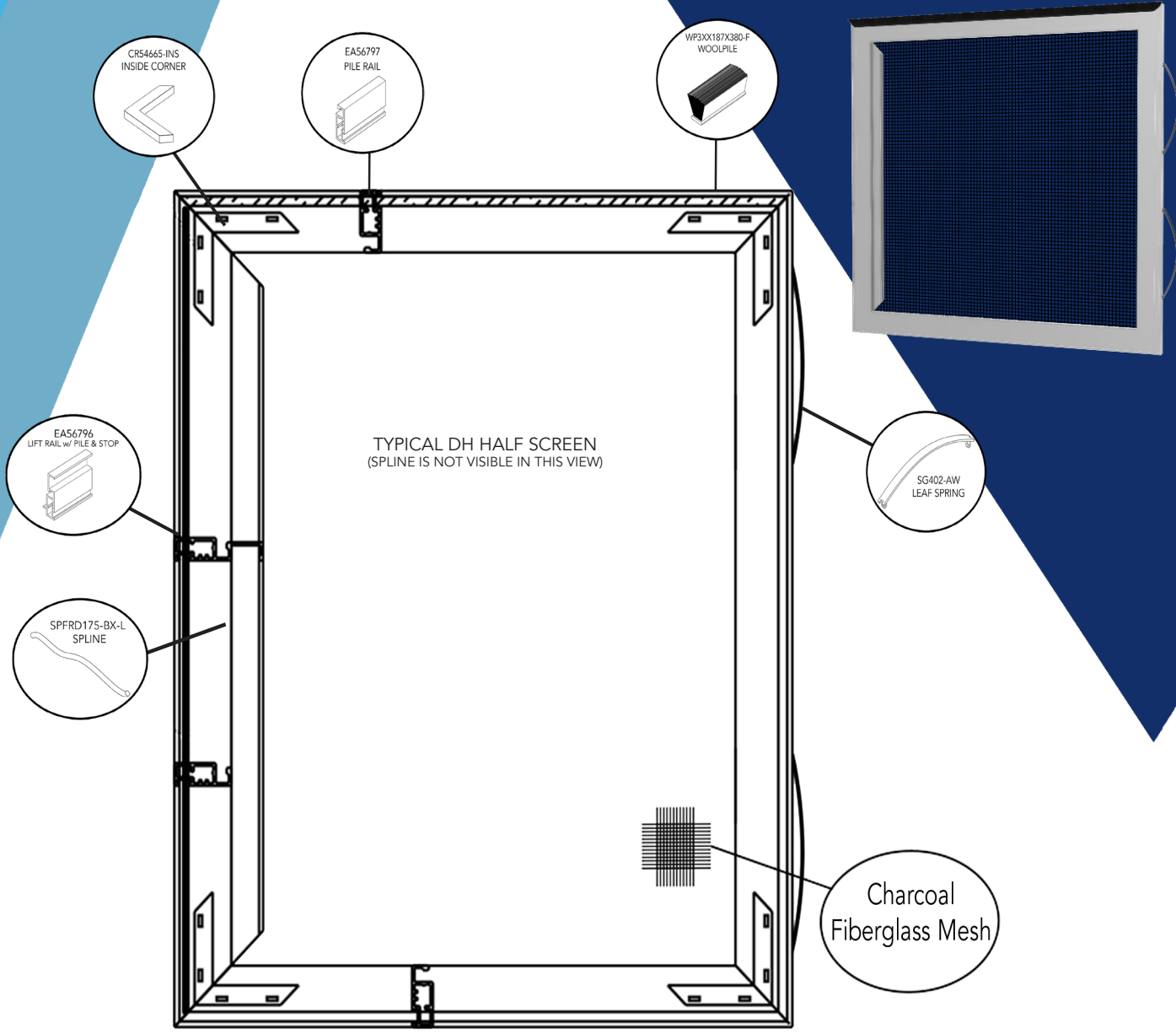

Standard Colors:

XXX in part numbers are place holders for Color Code

Black (L48)	
White (C01)	
Almond (A29)	
Clay (A22)	
Bronze (B16)	

Available in $\frac{5}{16}$ " , $\frac{3}{8}$ " and $\frac{7}{16}$ " , contact RiteScreen for details.

Series #	Fully Assembled Screen	Size	UOM	List Price
DH6	Minimum Price	0" to 49" UI	United Inch	\$39.66
DH6	U.I. Price	50" UI and Above	United Inch	\$0.8094

Part #	Description	Color	Length	UOM	QTY	List Price
EA56797-150-XXX	Pile Rail	Standard	12.5'	Box	20/pcs	\$658.24
EA56796-150-XXX	Lift Rail w/Pile and Stop	Standard	12.5'	Box	20/pcs	\$851.62
XCR54665-INS**	Inside Corner	Mill		Box	100/pcs	\$100.66
XSG402-AW**	Leaf Spring	Mill		Box	100/pcs	\$83.06
WP3XX187X380-F	.380" High Pile	Standard	4,000'	Box	4,000'	\$1,680.00
MSFG36X100-L00	36" x 100' Char Fiber Mesh	Charcoal	100'	Roll	400 ft ²	\$184.80
SPFRD175-BX-L	.175" Diameter Foam Spline	Black	5,000'	Box	5,000'	\$483.00

**Available in bulk quantities

DH7 - Double Hung Half Screen

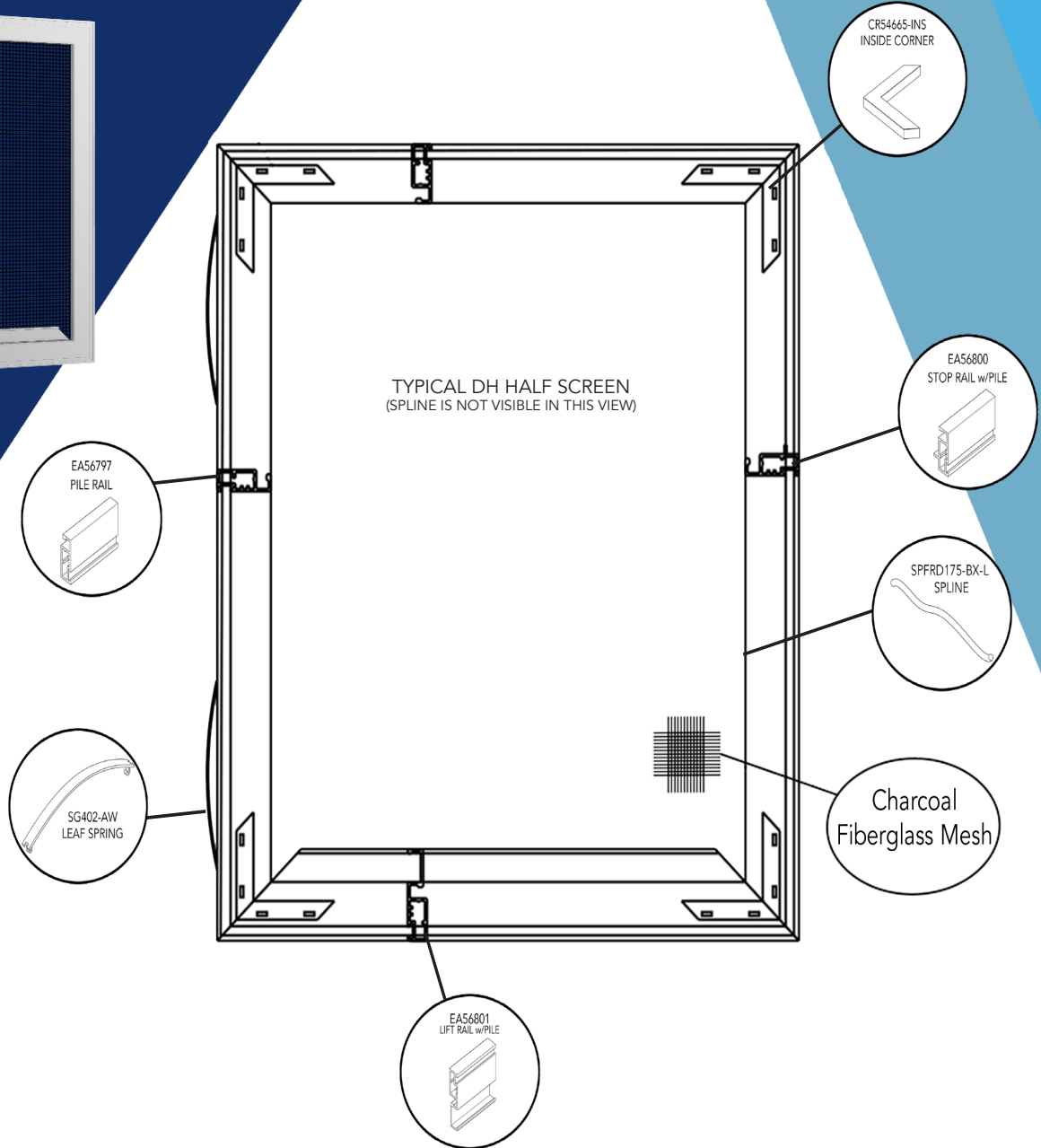
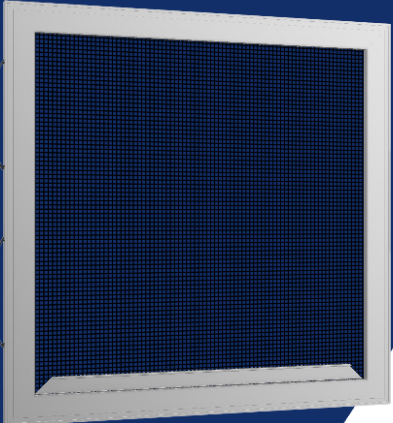

Available in $\frac{5}{16}$ " , $\frac{3}{8}$ " and $\frac{7}{16}$ " , contact RiteScreen for details.

Standard Colors:

XXX in part numbers are place holders for Color Code



Series #	Fully Assembled Screen	Size	UOM	List Price
DH7	Minimum Price	0" to 49" UI	United Inch	\$39.76
DH7	U.I. Price	50" UI and Above	United Inch	\$0.8116

Part #	Description	Color	Length	UOM	QTY	List Price
EA56797-150-XXX	Pile Rail	Standard	12.5'	Box	20/pcs	\$658.24
EA56801-150-XXX	Lift Rail w/Pile	Standard	12.5'	Box	20/pcs	\$821.04
EA56800-150-XXX	Stop Rail w/Pile	Standard	12.5'	Box	20/pcs	\$658.90
XCR54665-INS**	Inside Corner	Mill		Box	100/pcs	\$100.66
XSG402-AW**	Leaf Spring	Mill		Box	100/pcs	\$83.06
SPFRD175-BX-L	.175" Diameter Foam Spline	Black	5,000'	Box	5,000'	\$483.00
MSFG36X100-L00	36" x 100' Char Fiber Mesh	Charcoal	100'	Roll	400 ft ²	\$184.80

**Available in bulk quantities

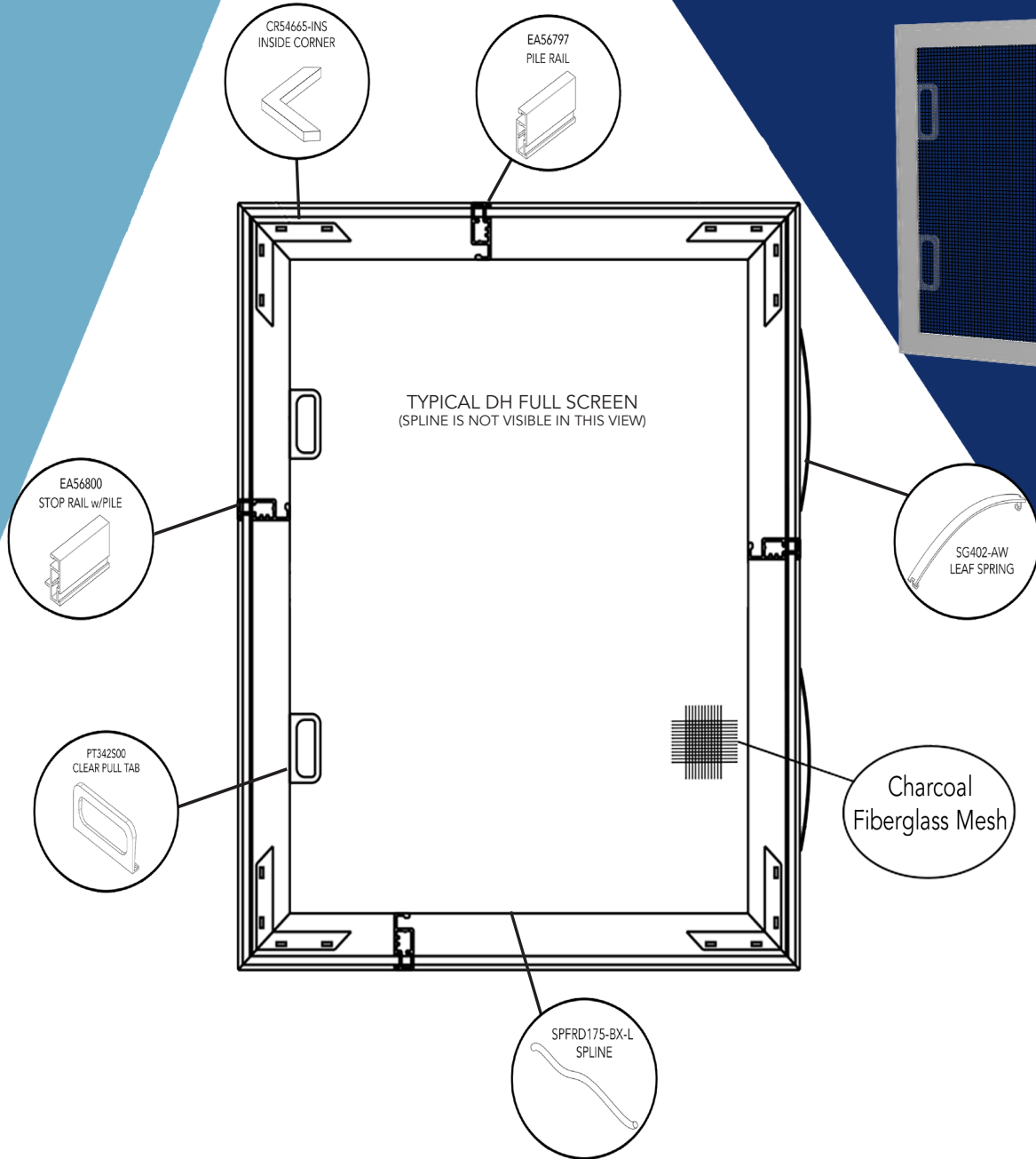

Standard Colors:

XXX in part numbers are
placeholders for Color Code

Black (L48)	
White (C01)	
Almond (A29)	
Clay (A22)	
Bronze (B16)	

Available in $\frac{5}{16}$ " , $\frac{3}{8}$ " and $\frac{7}{16}$ " , contact
RiteScreen for details.

Series #	Fully Assembled Screen	Size	UOM	List Price
DH8	Minimum Price	0" to 49" UI	United Inch	\$35.02
DH8	U.I. Price	50" UI and Above	United Inch	\$0.7146

Part #	Description	Color	Length	UOM	QTY	List Price
EA56797-150-XXX	Pile Rail	Standard	12.5'	Box	20/pcs	\$658.24
EA56800-150-XXX	Stop Rail w/Pile	Standard	12.5'	Box	20/pcs	\$658.90
XCR54665-INS**	Inside Corner	Mill		Box	100/pcs	\$100.66
XSG402-AW**	Leaf Spring	Mill		Box	100/pcs	\$83.06
XPT342S00**	Clear Pull Tab	Clear		Box	100/pcs	\$78.74
MSFG36X100-L00	36" x 100' Char Fiber Mesh	Charcoal	100'	Roll	400 ft ²	\$184.80
SPFRD175-BX-L	.175" Diameter Foam Spline	Black	5,000'	Box	5,000'	\$483.00

** Available in bulk quantities

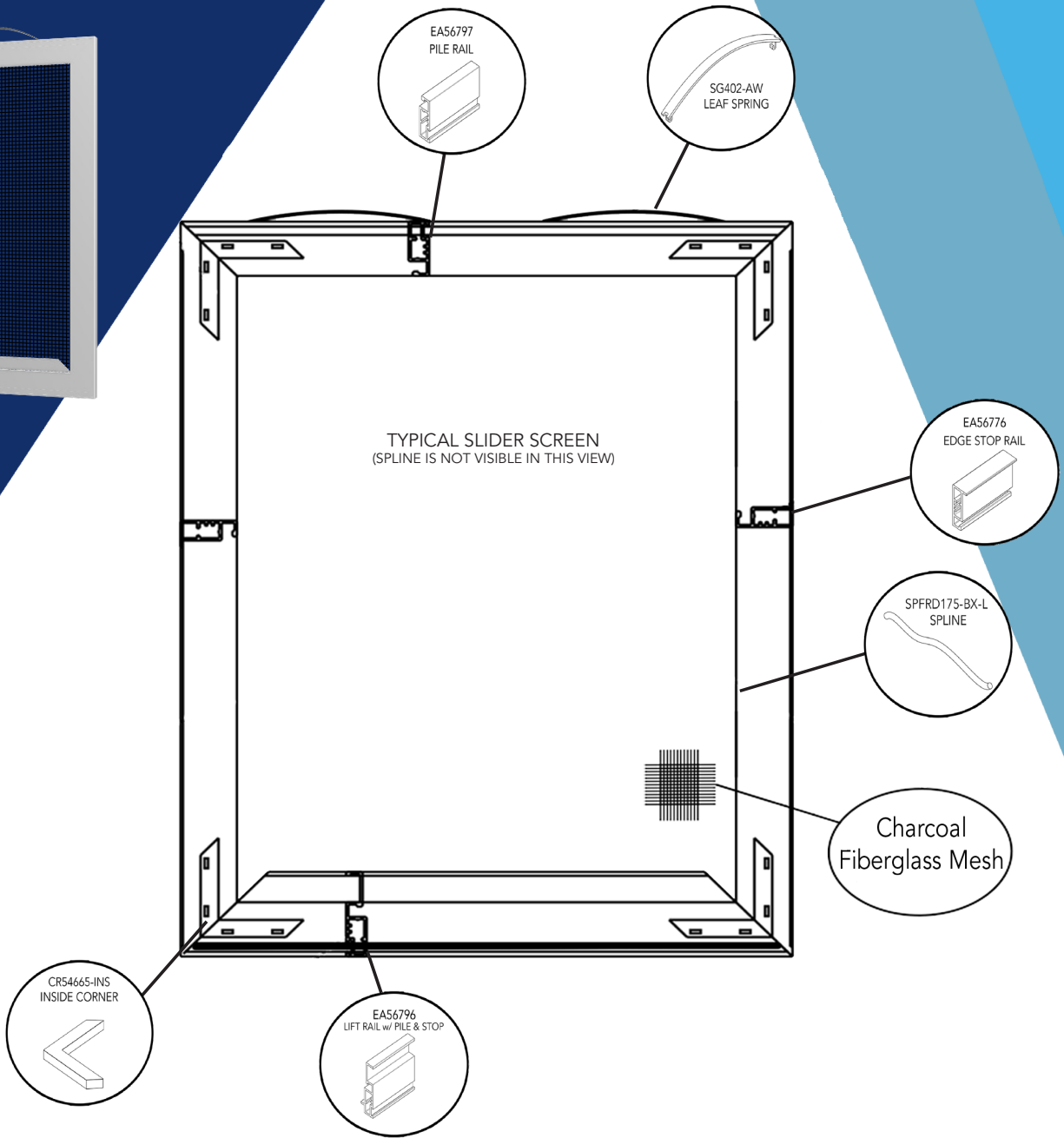
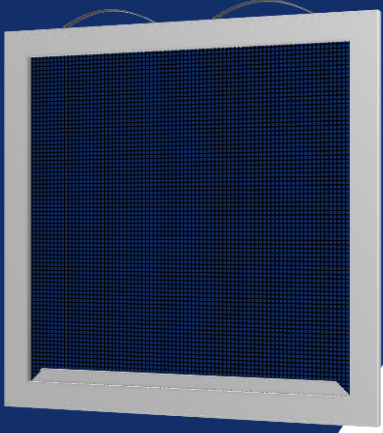

Available in $\frac{5}{16}$ " $\frac{3}{8}$ " and $\frac{7}{16}$ ", contact RiteScreen for details.

Standard Colors:

XXX in part numbers are place holders for Color Code



Series #	Fully Assembled Screen	Size	UOM	List Price
SL1	Minimum Price	0" to 49" UI	United Inch	\$37.08
SL1	U.I. Price	50" UI and Above	United Inch	\$0.7566

Part #	Description	Color	Length	UOM	QTY	List Price
EA56797-150-XXX	Pile Rail	Standard	12.5'	Box	20/pcs	\$658.24
EA56796-150-XXX	Lift Rail w/Pile and Stop	Standard	12.5'	Box	20/pcs	\$851.62
EA56776-150-XXX	Edge Stop Rail	Standard	12.5'	Box	20/pcs	\$664.62
XCR54665-INS**	Inside Corner	Mill		Box	100/pcs	\$100.66
XSG402-AW**	Leaf Spring	Mill		Box	100/pcs	\$83.06
MSFG36X100-L00	36" x 100' Char Fiber Mesh	Charcoal	100'	Roll	400 ft ²	\$184.80
SPFRD175-BX-L	.175" Diameter Foam Spline	Black	5,000'	Box	5,000'	\$483.00

** Available in bulk quantities

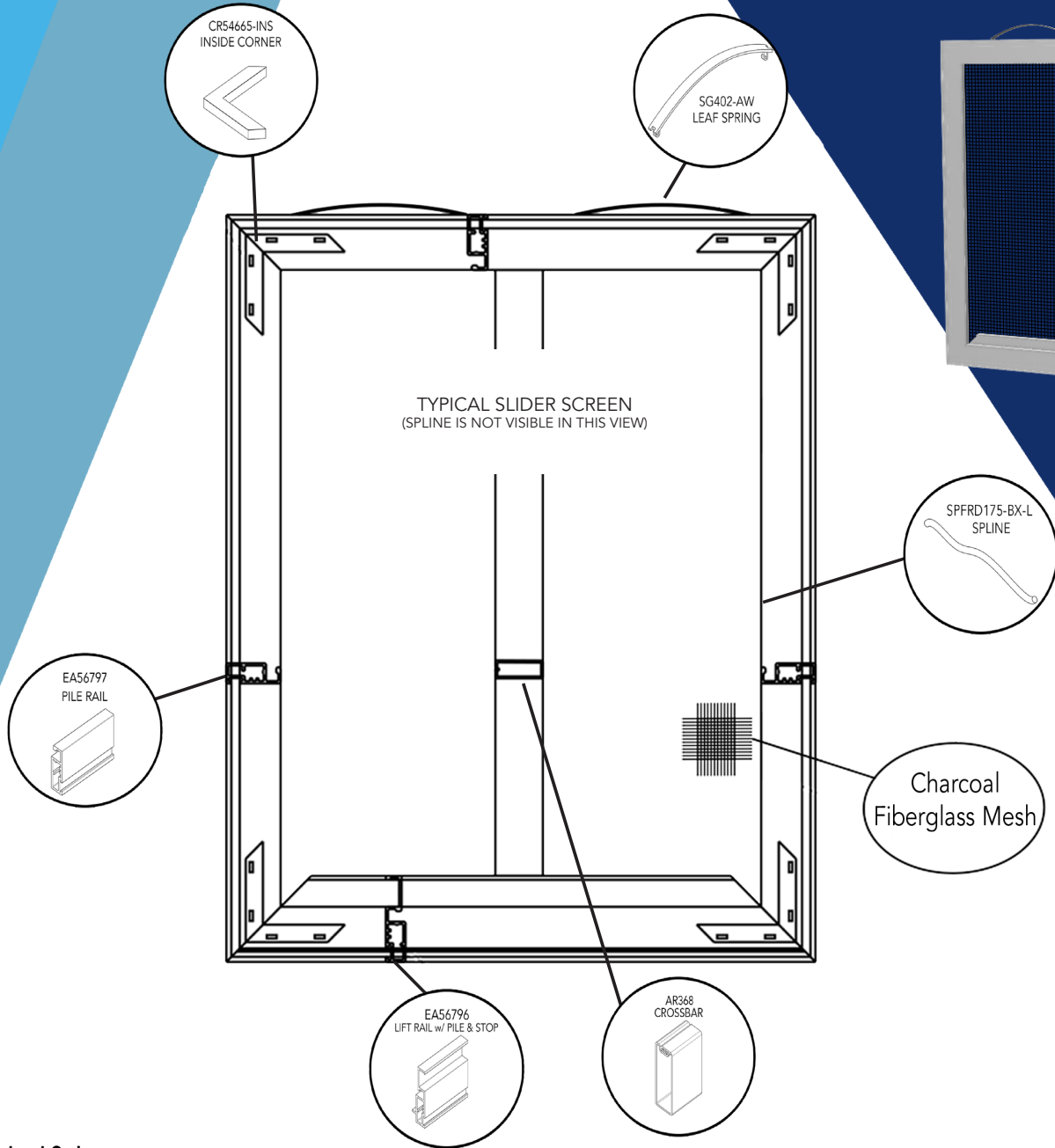

Standard Colors:

XXX in part numbers are place holders for Color Code

Black (L48)	
White (C01)	
Almond (A29)	
Clay (A22)	
Bronze (B16)	

Available in $\frac{5}{16}$ " , $\frac{3}{8}$ " and $\frac{7}{16}$ " , contact RiteScreen for details.

Series #	Fully Assembled Screen	Size	UOM	List Price
SL2	Minimum Price	0" to 49" UI	United Inch	\$38.10
SL2	U.I. Price	50" UI and Above	United Inch	\$0.7776

Part #	Description	Color	Length	UOM	QTY	List Price
EA56797-150-XXX	Pile Rail	Standard	12.5'	Box	20/pcs	\$658.24
EA56796-150-XXX	Lift Rail w/Pile and Stop	Standard	12.5'	Box	20/pcs	\$851.62
AR368-16-12XXX	Crossbar	Standard	12.5'	Box	152/pcs	\$1,583.36
XCR54665-INS**	Inside Corner	Mill		Box	100/pcs	\$100.66
XSG402-AW**	Leaf Spring	Mill		Box	100/pcs	\$83.06
MSFG36X100-L00	36" x 100' Char Fiber Mesh	Charcoal	100'	Roll	400 ft ²	\$184.80
SPFRD175-BX-L	.175" Diameter Foam Spline	Black	5,000'	Box	5,000'	\$483.00

**Available in bulk quantities

SL3 - Slider Screen

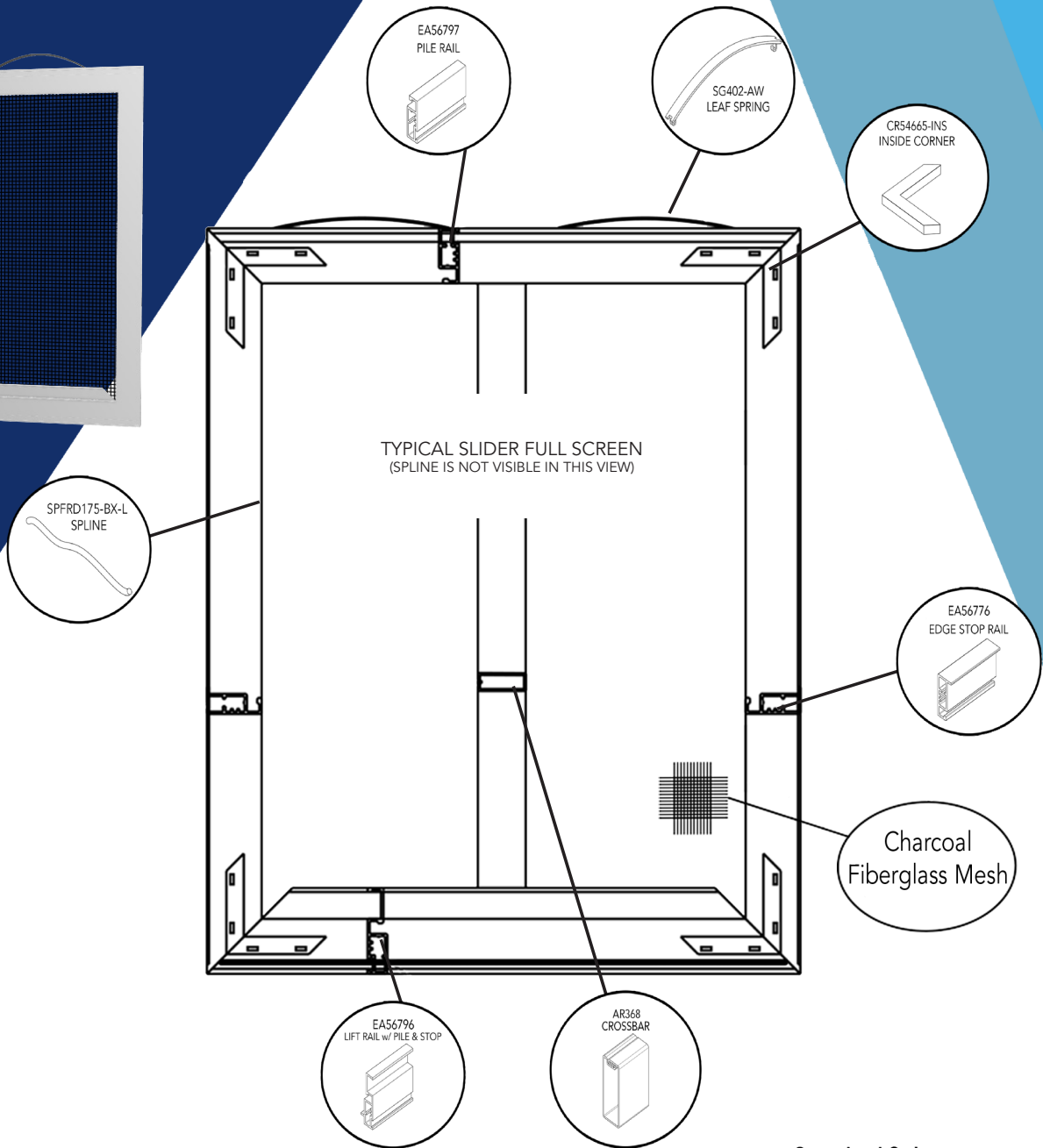
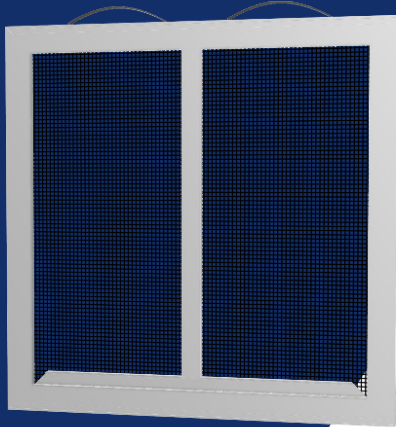

Available in $\frac{5}{16}$ " , $\frac{3}{8}$ " and $\frac{7}{16}$ " , contact RiteScreen for details.

Standard Colors:

XXX in part numbers are place holders for Color Code

White (C01)



Almond (A29)

Black (L48)

Clay (A22)

Bronze (B16)

Series #	Fully Assembled Screen	Size	UOM	List Price
SL3	Minimum Price	0" to 49" UI	United Inch	\$38.10
SL3	U.I. Price	50" UI and Above	United Inch	\$0.7776

Part #	Description	Color	Length	UOM	QTY	List Price
EA56797-150-XXX	Pile Rail	Standard	12.5'	Box	20/pcs	\$658.24
EA56796-150-XXX	Lift Rail w/Pile and Stop	Standard	12.5'	Box	20/pcs	\$851.62
EA56776-150-XXX	Edge Stop Rail	Standard	12.5'	Box	20/pcs	\$664.62
AR368-16-12XXX	Crossbar	Standard	12.5'	Box	152/pcs	\$1,583.36
XCR54665-INS**	Inside Corner	Mill		Box	100/pcs	\$100.66
XSG402-AW**	Leaf Spring	Mill		Box	100/pcs	\$83.06
MSFG36X100-L00	36" x 100' Char Fiber Mesh	Charcoal	100'	Roll	400 ft ²	\$184.80
SPFRD175-BX-L	.175" Diameter Foam Spline	Black	5,000'	Box	5,000'	\$483.00

**Available in bulk quantities

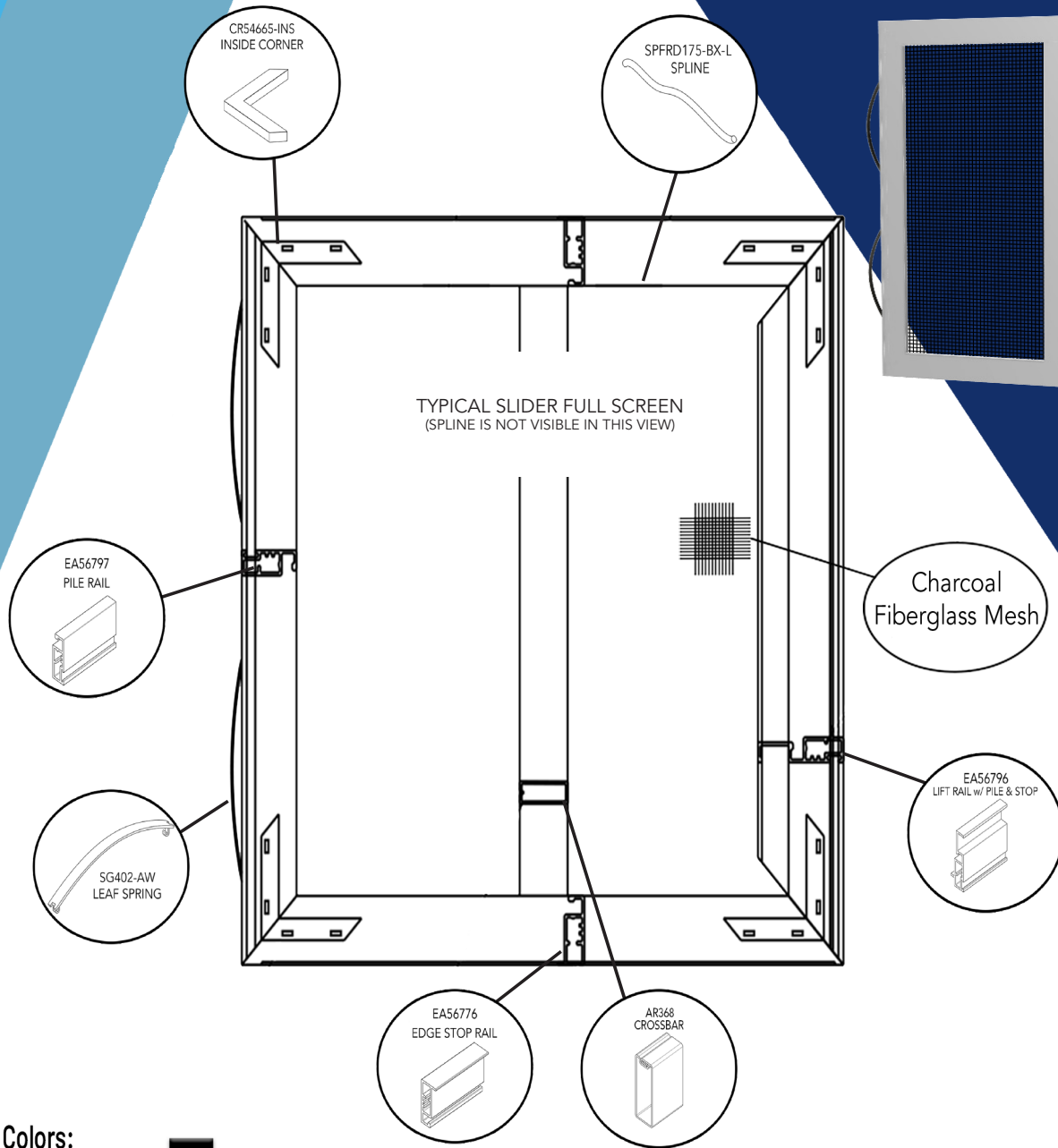

Standard Colors:

XXX in part numbers are place holders for Color Code

Black (L48)	
White (C01)	
Almond (A29)	
Clay (A22)	
Bronze (B16)	

Available in $\frac{5}{16}$ " , $\frac{3}{8}$ " and $\frac{7}{16}$ " contact RiteScreen for details.

Series #	Fully Assembled Screen	Size	UOM	List Price
SL4	Minimum Price	0" to 49" UI	United Inch	\$38.10
SL4	U.I. Price	50" UI and Above	United Inch	\$0.7776

Part #	Description	Color	Length	UOM	QTY	List Price
EA56797-150-XXX	Pile Rail	Standard	12.5'	Box	20/pcs	\$658.24
EA56796-150-XXX	Lift Rail w/Pile and Stop	Standard	12.5'	Box	20/pcs	\$851.62
EA56776-150-XXX	Edge Stop Rail	Standard	12.5'	Box	20/pcs	\$664.62
AR368-16-12XXX	Crossbar	Standard	12.5'	Box	152/pcs	\$1,583.36
XCR54665-INS**	Inside Corner	Mill		Box	100/pcs	\$100.66
XSG402-AW**	Leaf Spring	Mill		Box	100/pcs	\$83.06
MSFG36X100-L00	36" x 100' Char Fiber Mesh	Charcoal	100'	Roll	400 ft ²	\$184.80
SPFRD175-BX-L	.175" Diameter Foam Spline	Black	5,000'	Box	5,000'	\$483.00

**Available in bulk quantities

SL5 - Slider Half Screen

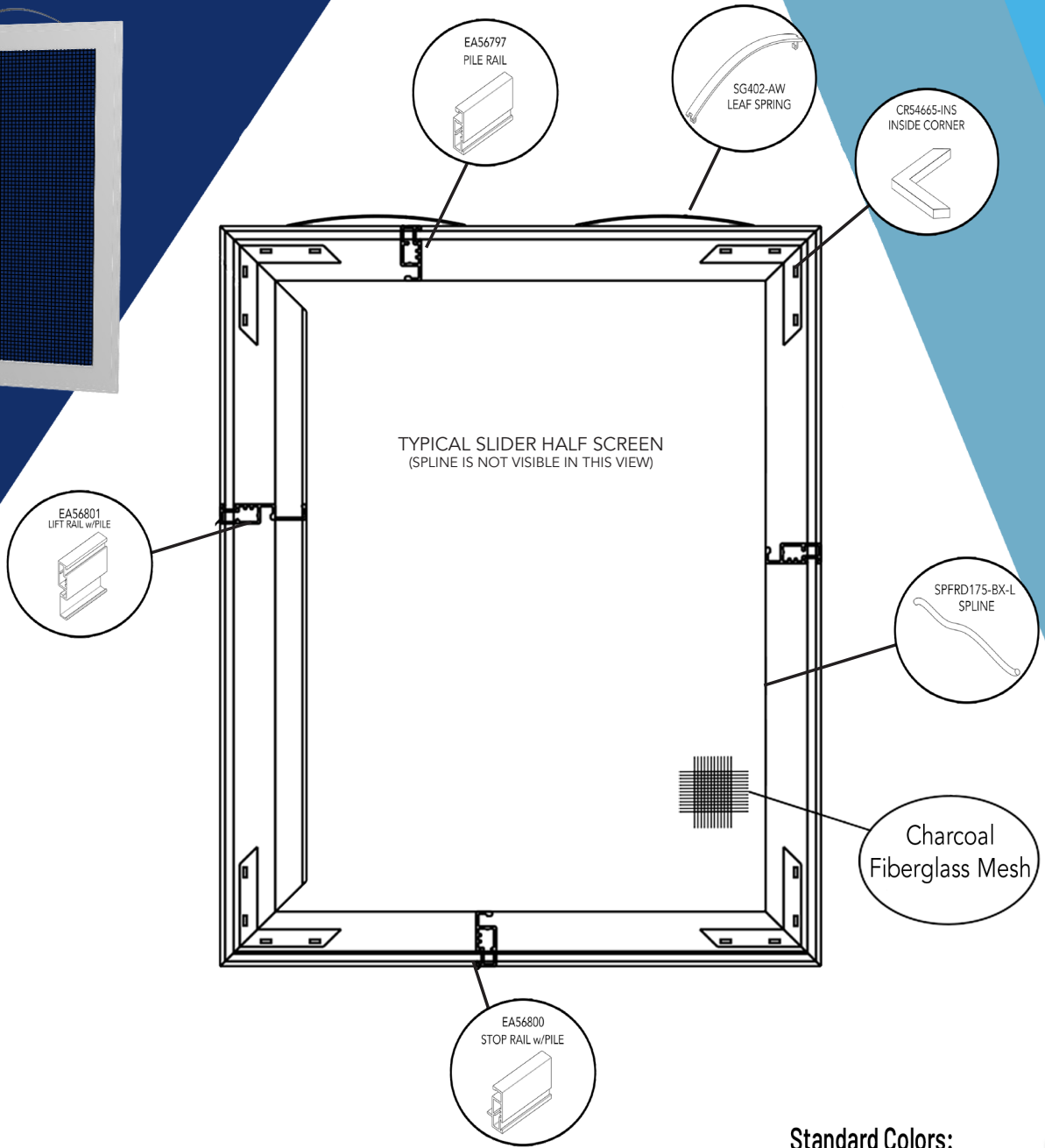
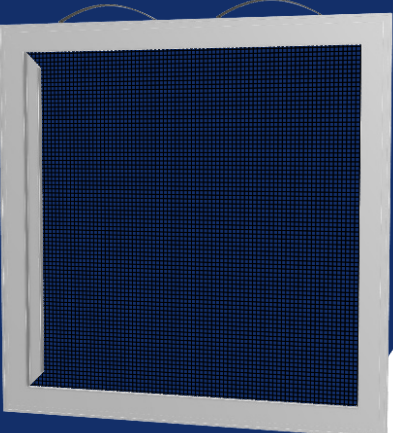

Available in $\frac{5}{16}$ " , $\frac{3}{8}$ " and $\frac{7}{16}$ " , contact RiteScreen for details.

Standard Colors:

XXX in part numbers are place holders for Color Code

White (C01)	Clay (A22)	Black (L48)
Almond (A29)	Bronze (B16)	

Series #	Fully Assembled Screen	Size	UOM	List Price
SL5	Minimum Price	0" to 49" UI	United Inch	\$38.74
SL5	U.I. Price	50" UI and Above	United Inch	\$0.7908

Part #	Description	Color	Length	UOM	QTY	List Price
EA56797-150-XXX	Pile Rail	Standard	12.5'	Box	20/pcs	\$658.24
EA56800-150-XXX	Stop Rail w/Pile	Standard	12.5'	Box	20/pcs	\$658.90
EA56801-150-XXX	Lift Rail w/Pile	Standard	12.5'	Box	20/pcs	\$821.04
XCR54665-INS**	Inside Corner	Mill		Box	100/pcs	\$100.66
XSG402-AW**	Leaf Spring	Mill		Box	100/pcs	\$83.06
MSFG36X100-L00	36" x 100' Char Fiber Mesh	Charcoal	100'	Roll	400 ft ²	\$184.80
SPFRD175-BX-L	.175" Diameter Foam Spline	Black	5,000'	Box	5,000'	\$483.00

**Available in bulk quantities

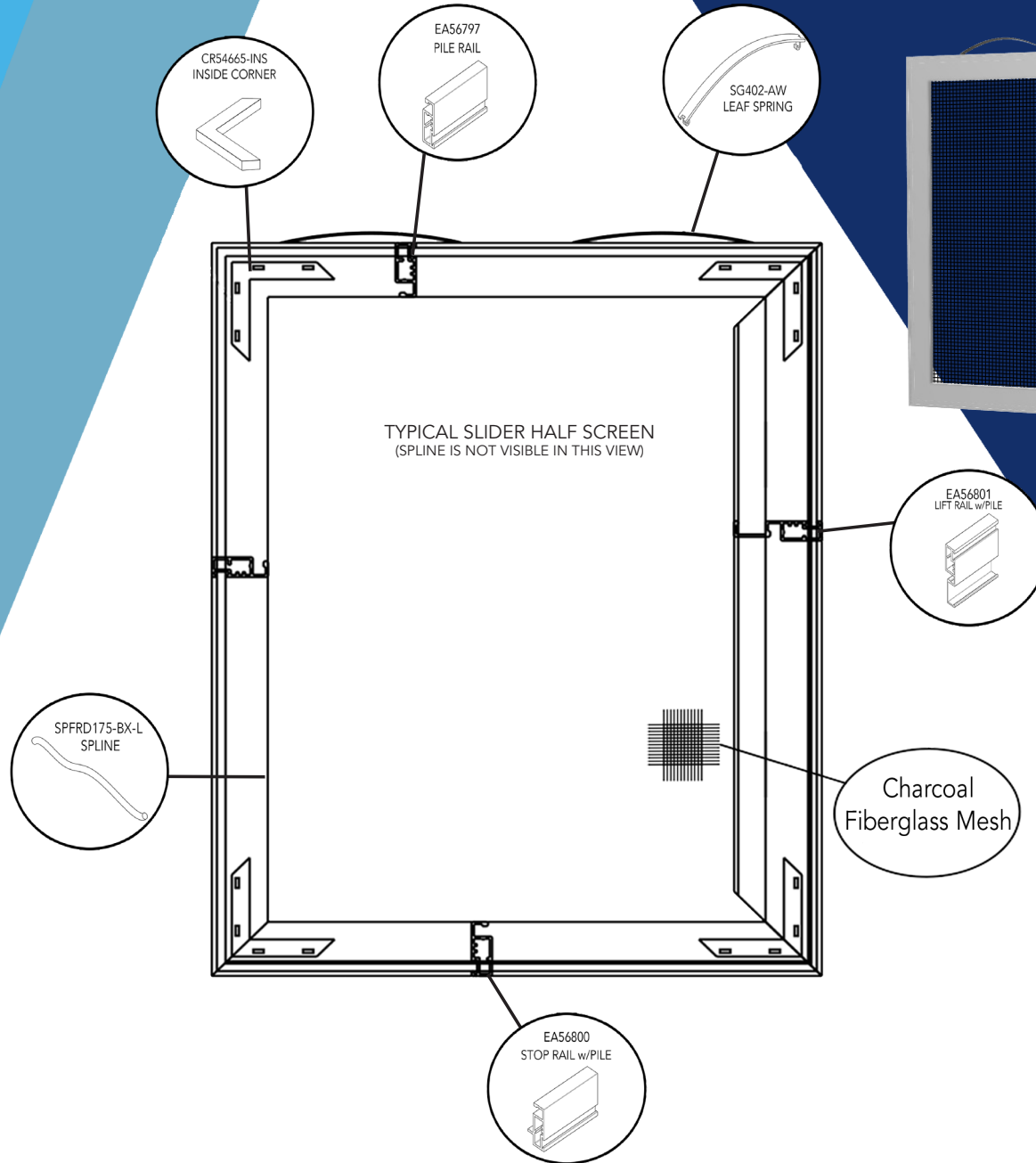

Standard Colors:

XXX in part numbers are place holders for Color Code

Black (L48)	
White (C01)	
Almond (A29)	
Clay (A22)	
Bronze (B16)	

Available in $\frac{5}{16}$ " , $\frac{3}{8}$ " and $\frac{7}{16}$ " contact RiteScreen for details.

Series #	Fully Assembled Screen	Size	UOM	List Price
SL6	Minimum Price	0" to 49" UI	United Inch	\$38.74
SL6	U.I. Price	50" UI and Above	United Inch	\$0.7908

Part #	Description	Color	Length	UOM	QTY	List Price
EA56797-150-XXX	Pile Rail	Standard	12.5'	Box	20/pcs	\$658.24
EA56800-150-XXX	Stop Rail w/Pile	Standard	12.5'	Box	20/pcs	\$658.90
EA56801-150-XXX	Lift Rail w/Pile	Standard	12.5'	Box	20/pcs	\$821.04
XCR54665-INS**	Inside Corner	Mill		Box	100/pcs	\$100.66
XSG402-AW**	Leaf Spring	Mill		Box	100/pcs	\$83.06
MSFG36X100-L00	36" x 100' Char Fiber Mesh	Charcoal	100'	Roll	400 ft ²	\$184.80
SPFRD175-BX-L	.175" Diameter Foam Spline	Black	5,000'	Box	5,000'	\$483.00

**Available in bulk quantities

SL7 - Slider Half Screen

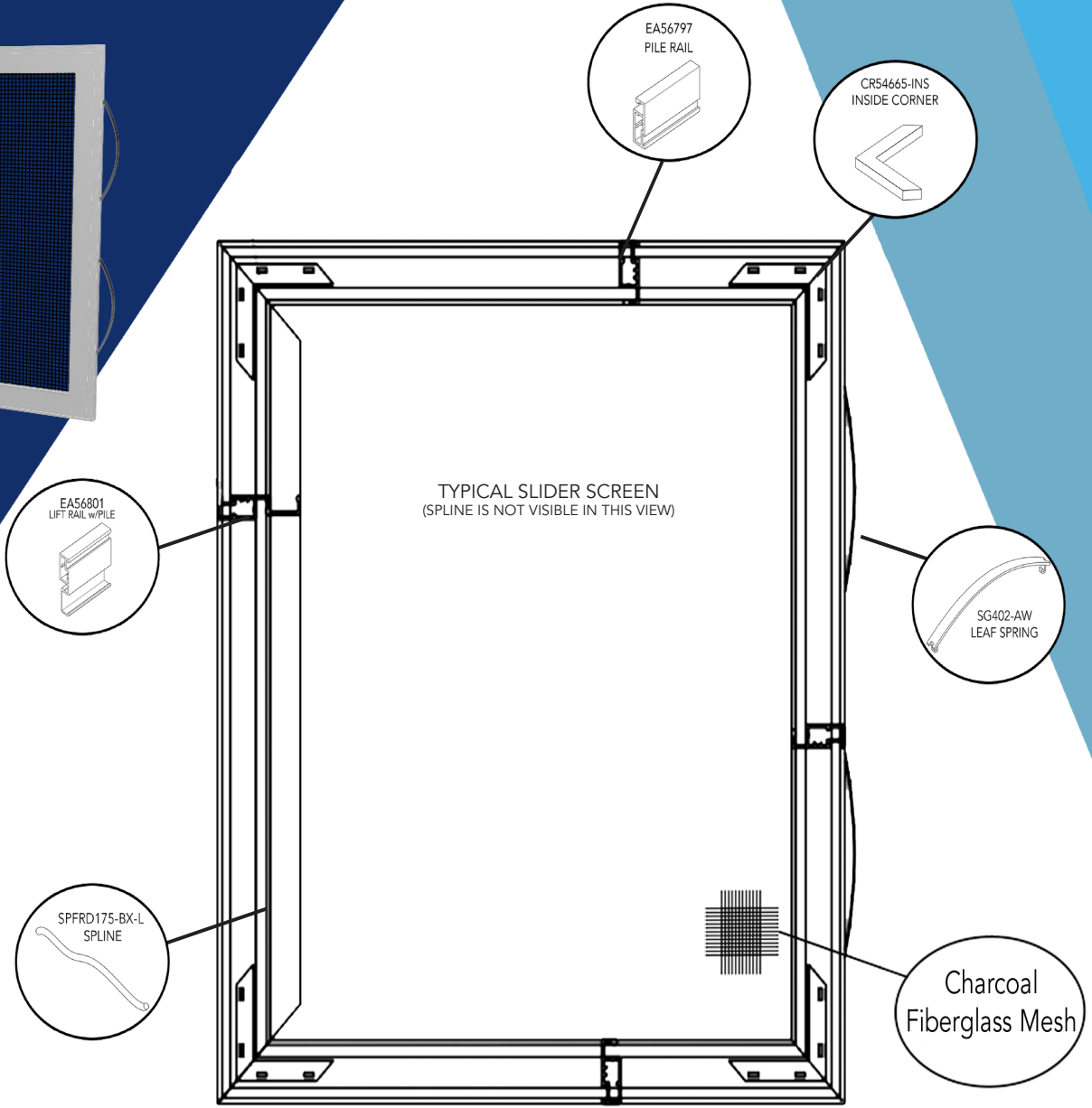
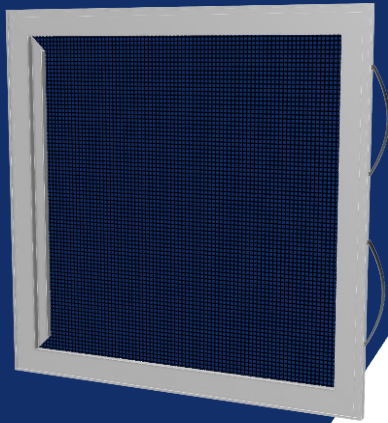

*Made in Pennsylvania

Available in $\frac{5}{16}$ " , $\frac{3}{8}$ " and $\frac{7}{16}$ " , contact RiteScreen for details.

Standard Colors:

XXX in part numbers are place holders for Color Code



Series #	Fully Assembled Screen	Size	UOM	List Price
SL7	Minimum Price	0" to 49" UI	United Inch	\$38.74
SL7	U.I. Price	50" UI and Above	United Inch	\$0.7908

Part #	Description	Color	Length	UOM	QTY	List Price
EA56797-150-XXX	Pile Rail	Standard	12.5'	Box	20/pcs	\$658.24
EA56801-150-XXX	Lift Rail w/Pile	Standard	12.5'	Box	20/pcs	\$821.04
XCR54665-INS**	Inside Corner	Mill		Box	100/pcs	\$100.66
XSG402-AW**	Leaf Spring	Mill		Box	100/pcs	\$83.06
MSFG36X100-L00	36" x 100' Char Fiber Mesh	Charcoal	100'	Roll	400 ft ²	\$184.80
SPFRD175-BX-L	.175" Diameter Foam Spline	Black	5,000'	Box	5,000'	\$483.00

** Available in bulk quantities

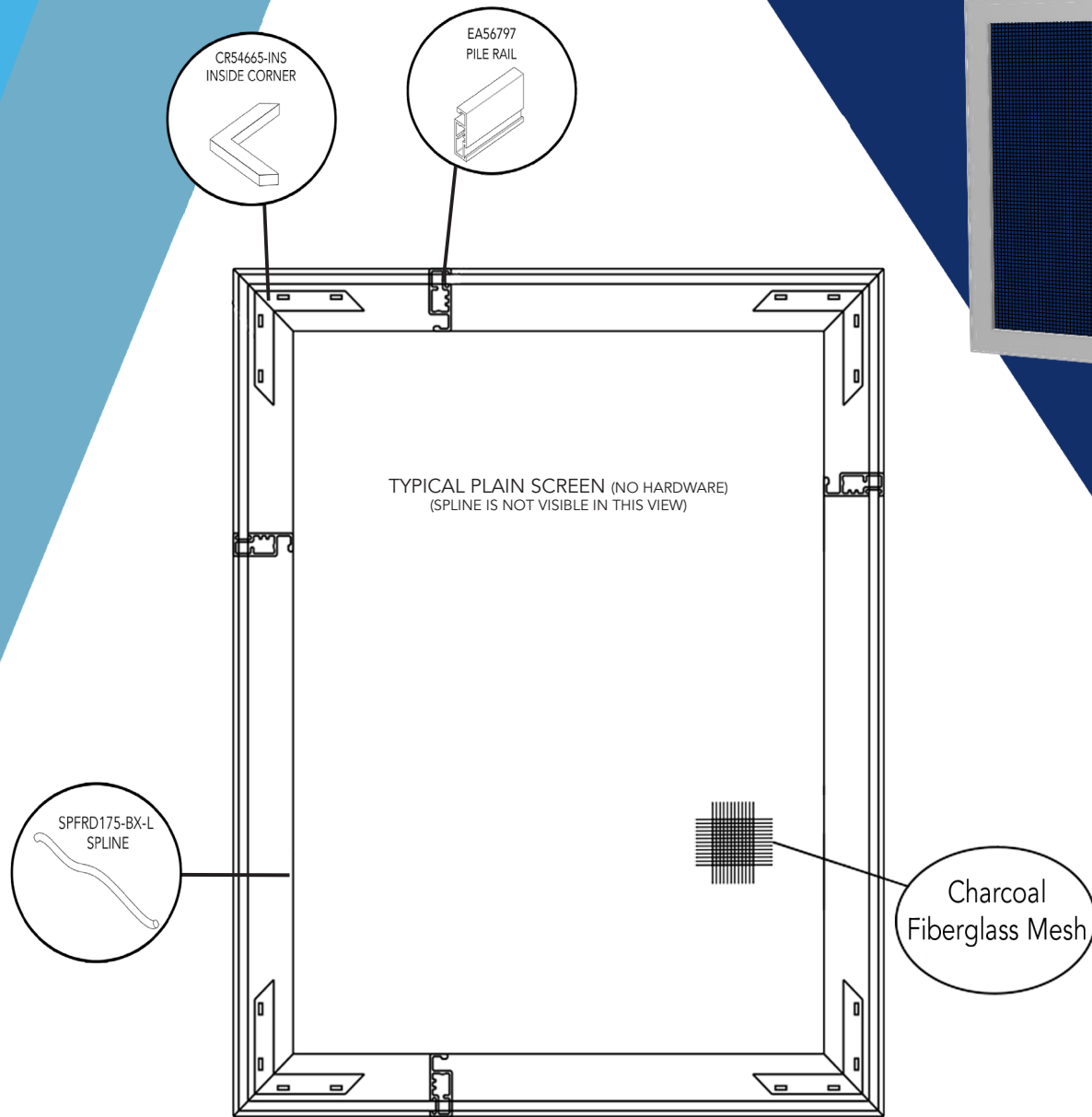

Standard Colors:

XXX in part numbers are place holders for Color Code

Black (L48)	
White (C01)	
Almond (A29)	
Clay (A22)	
Bronze (B16)	

Available in $\frac{5}{16}$ " , $\frac{3}{8}$ " and $\frac{7}{16}$ " contact RiteScreen for details.

Series #	Fully Assembled Screen	Size	UOM	List Price
FS1	Minimum Price	0" to 49" UI	United Inch	\$35.46
FS1	U.I. Price	50" UI and Above	United Inch	\$0.7236

Part #	Description	Color	Length	UOM	QTY	List Price
EA56797-150-XXX	Pile Rail	Standard	12.5'	Box	20/pcs	\$658.24
XCR54665-INS**	Inside Corner	Mill		Box	100/pcs	\$100.66
SPFRD175-BX-L	.175" Diameter Foam Spline	Black	5,000'	Box	5,000'	\$483.00
MSFG36X100-L00	36" x 100' Char Fiber Mesh	Charcoal	100'	Roll	400 ft ²	\$184.80

**Available in bulk quantities

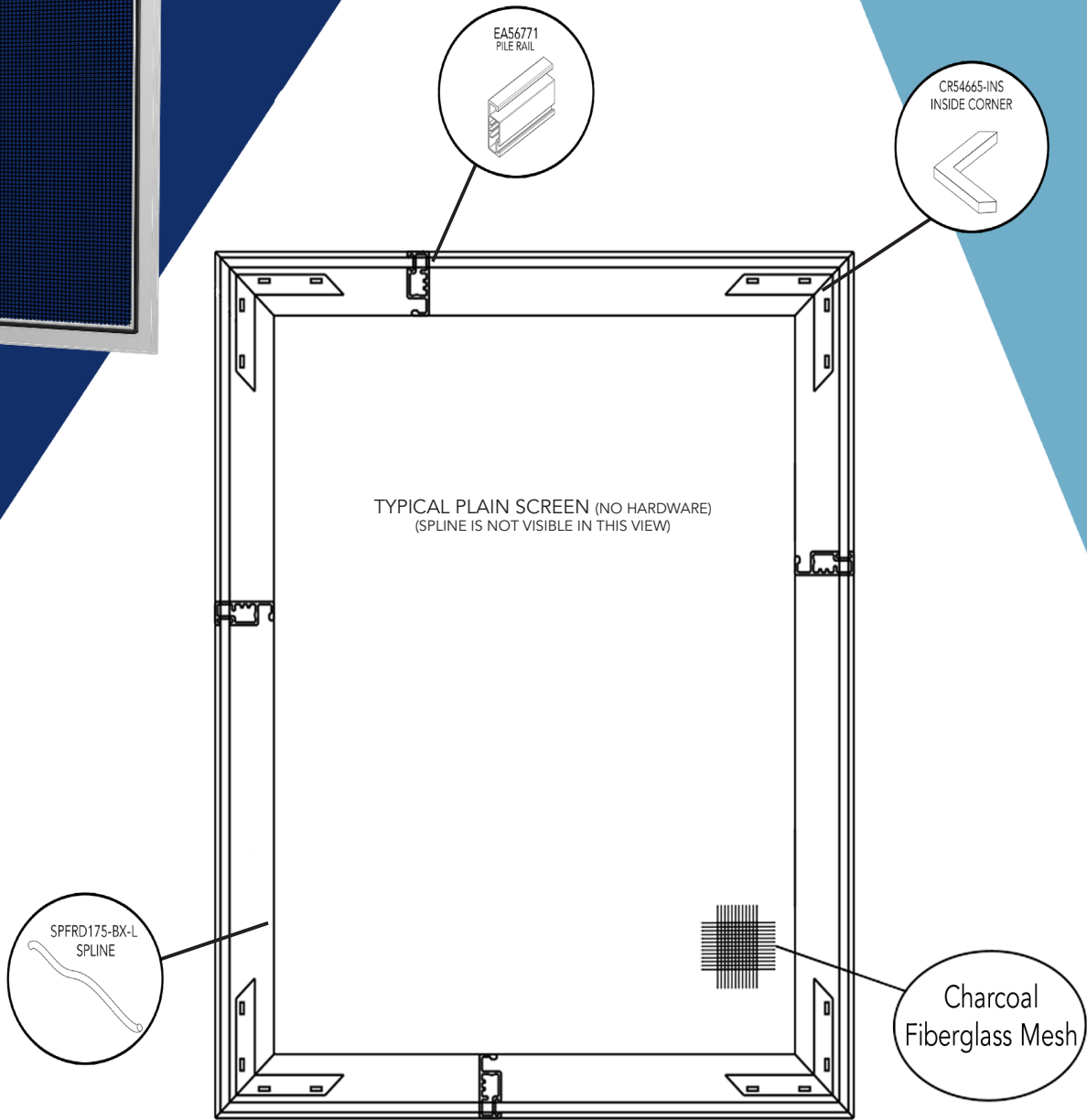
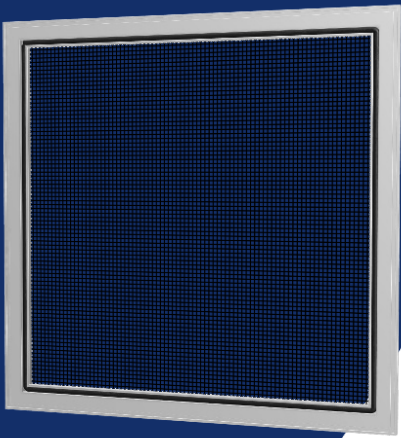

Available in $\frac{5}{16}$ " , $\frac{3}{8}$ " and $\frac{7}{16}$ " , contact RiteScreen for details.

Standard Colors:

XXX in part numbers are place holders for Color Code



Series #	Fully Assembled Screen	Size	UOM	List Price
FS2	Minimum Price	0" to 49" UI	United Inch	\$35.46
FS2	U.I. Price	50" UI and Above	United Inch	\$0.7236

Part #	Description	Color	Length	UOM	QTY	List Price
EA56771-150-XXX	Pile Rail	Standard	12.5'	Box	20/pcs	\$734.14
XCR54665-INS**	Inside Corner	Mill		Box	100/pcs	\$100.66
SPFRD175-BX-L	.175" Diameter Foam Spline	Black	5,000'	Box	5,000'	\$483.00
MSFG36X100-L00	36" x 100' Char Fiber Mesh	Charcoal	100'	Roll	400 ft ²	\$184.80

**Available in bulk quantities

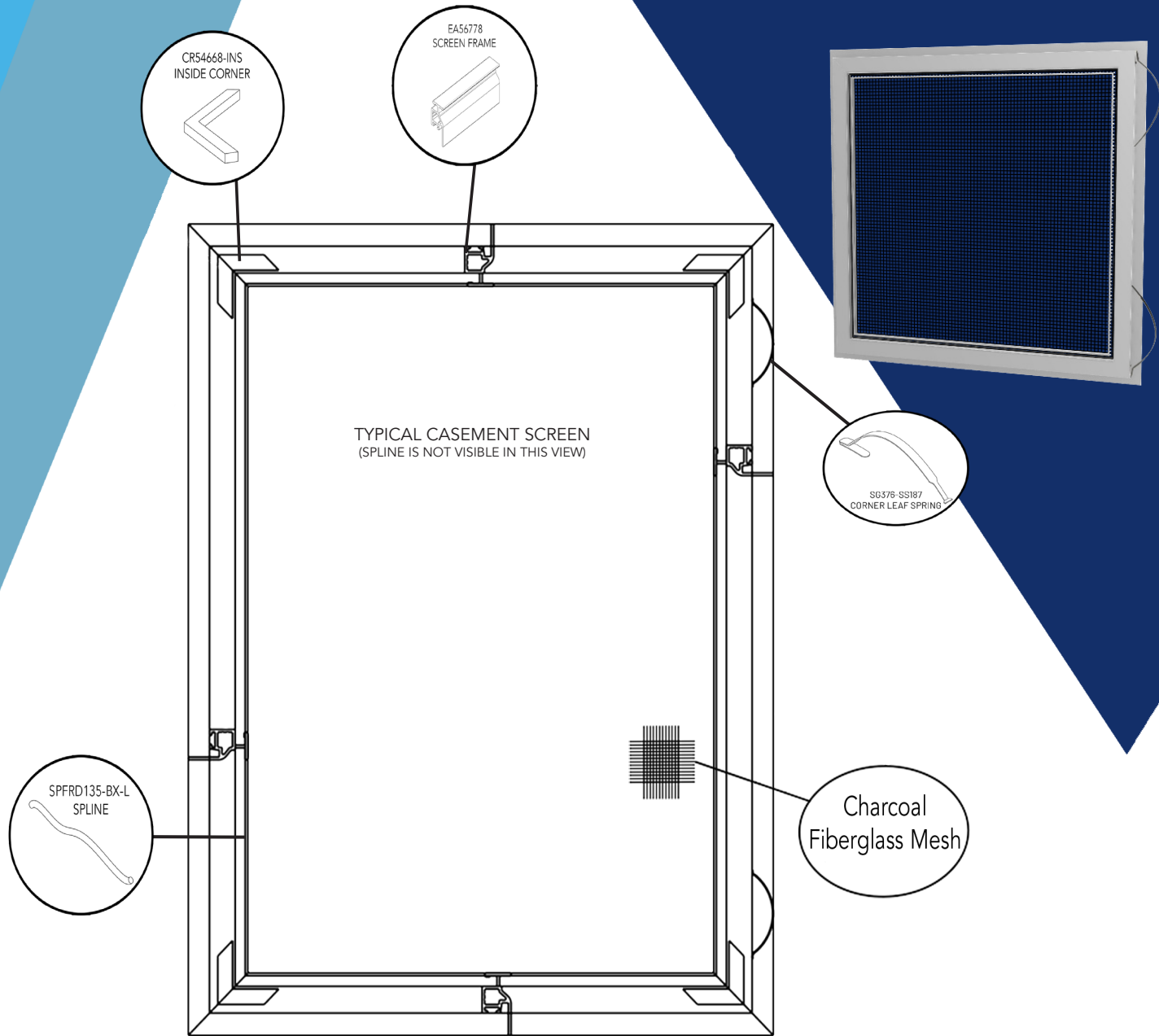

Standard Colors:

XXX in part numbers are place holders for Color Code

Black (L48)	
White (C01)	
Almond (A29)	
Clay (A22)	
Bronze (B16)	

Only available in 3/8"

Series #	Fully Assembled Screen	Size	UOM	List Price
CA1	Minimum Price	0" to 49" UI	United Inch	\$39.68
CA1	U.I. Price	50" UI and Above	United Inch	\$0.8096

Part #	Description	Color	Length	UOM	QTY	List Price
EA56778-150-XXX	Screen Frame	Standard	12.5'	Box	20/ea	\$797.28
XCR54668-INS**	Inside Corner	Mill		Box	100/pcs	\$111.74
XSG376-SS187**	Corner Leaf Spring	Mill		Box	100/pcs	\$165.60
MSFG36X100-L00	36" x 100' Char Fiber Mesh	Charcoal	100'	Roll	400 ft ²	\$184.80
SPFRD135-BX-L	.135" Diameter Foam Spline	Black	8,000'	Box	8,000'	\$564.48

**Available in bulk quantities

CA2 - Extruded Casement Screen

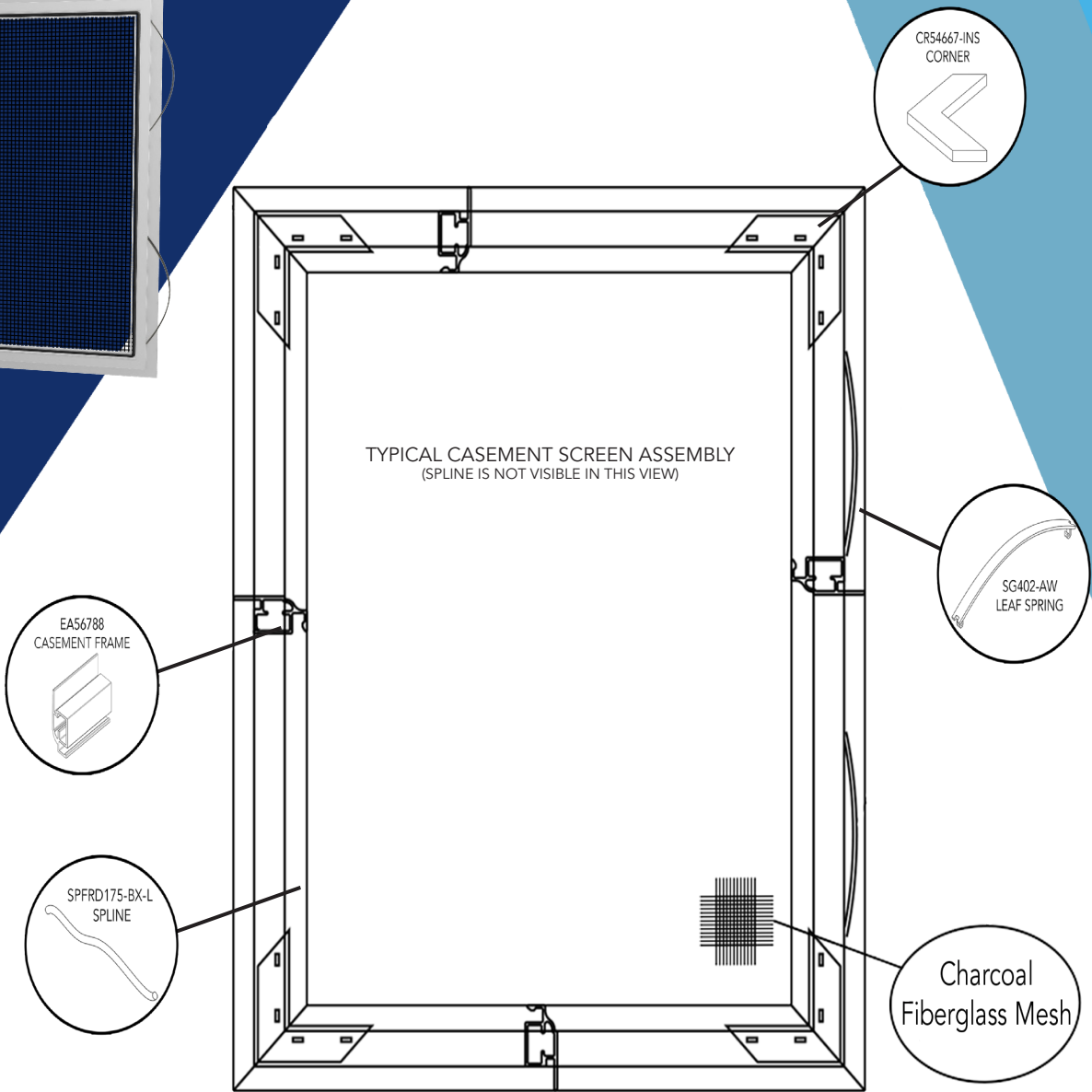
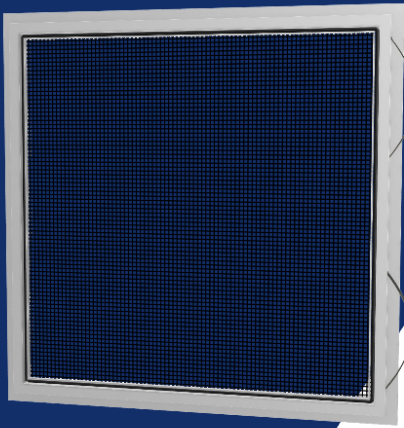

Only available in 7/16"

Standard Colors:

XXX in part numbers are place holders for Color Code



Series #	Fully Assembled Screen	Size	UOM	List Price
CA2	Minimum Price	0" to 49" UI	United Inch	\$45.42
CA2	U.I. Price	50" UI and Above	United Inch	\$0.9268

Part #	Description	Color	Length	UOM	QTY	List Price
EA56788-150-XXX	Casement Frame	Standard	12.5'	Box	20/pcs	\$875.82
XCR54667-INS**	Corner	Mill		Box	100/pcs	\$111.74
XSG402-AW**	Leaf Spring	Mill		Box	100/pcs	\$83.06
MSFG36X100-L00	36" x 100' Char Fiber Mesh	Charcoal	100'	Roll	400 ft ²	\$184.80
SPFRD175-BX-L	.175" Diameter Foam Spline	Black	5,000'	Box	5,000'	\$483.00

**Available in bulk quantities

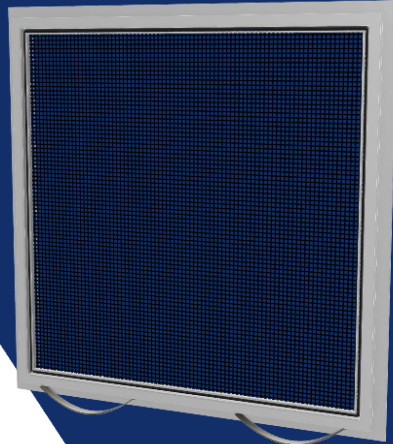
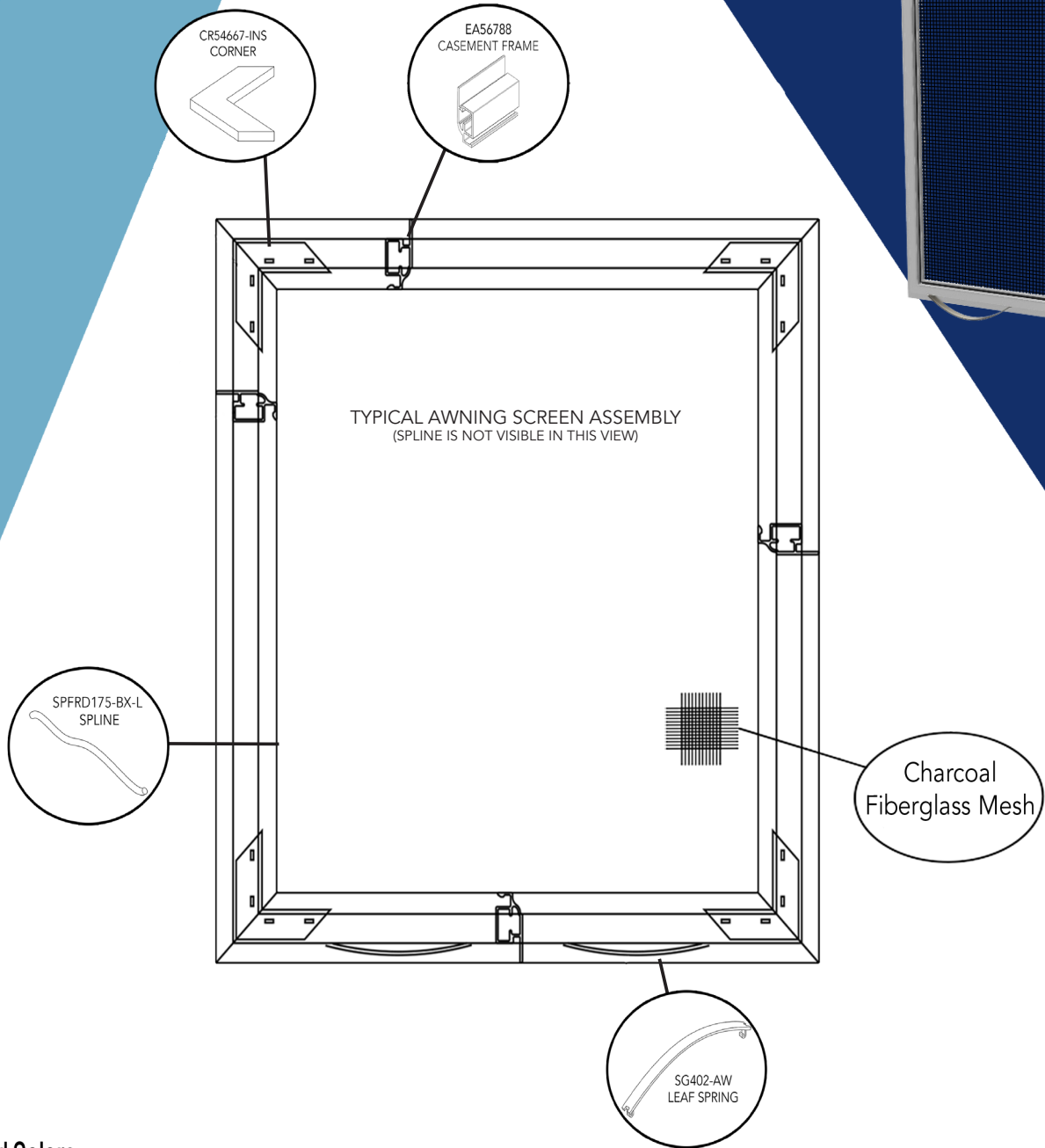

Standard Colors:

XXX in part numbers are place holders for Color Code

Black (L48)	
White (C01)	
Almond (A29)	
Clay (A22)	
Bronze (B16)	

Only available in 7/16"

Series #	Fully Assembled Screen	Size	UOM	List Price
CA3	Minimum Price	0" to 49" UI	United Inch	\$39.32
CA3	U.I. Price	50" UI and Above	United Inch	\$0.8024

Part #	Description	Color	Length	UOM	QTY	List Price
EA56788-150-XXX	Casement Frame	Standard	12.5'	Box	20/pcs	\$875.82
XCR54667-INS**	Corner	Mill		Box	100/pcs	\$111.74
XSG402-AW**	Leaf Spring	Mill		Box	100/pcs	\$83.06
MSFG36X100-L00	36" x 100' Char Fiber Mesh	Charcoal	100'	Roll	400 ft ²	\$184.80
SPFRD175-BX-L	.175" Diameter Foam Spline	Black	5,000'	Box	5,000'	\$483.00

**Available in bulk quantities

CA4 - Extruded Casement Screen

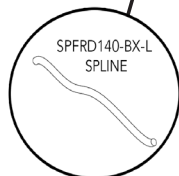
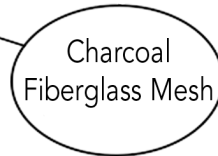
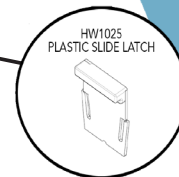
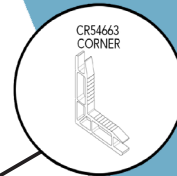
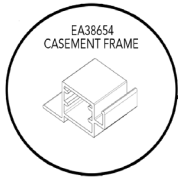
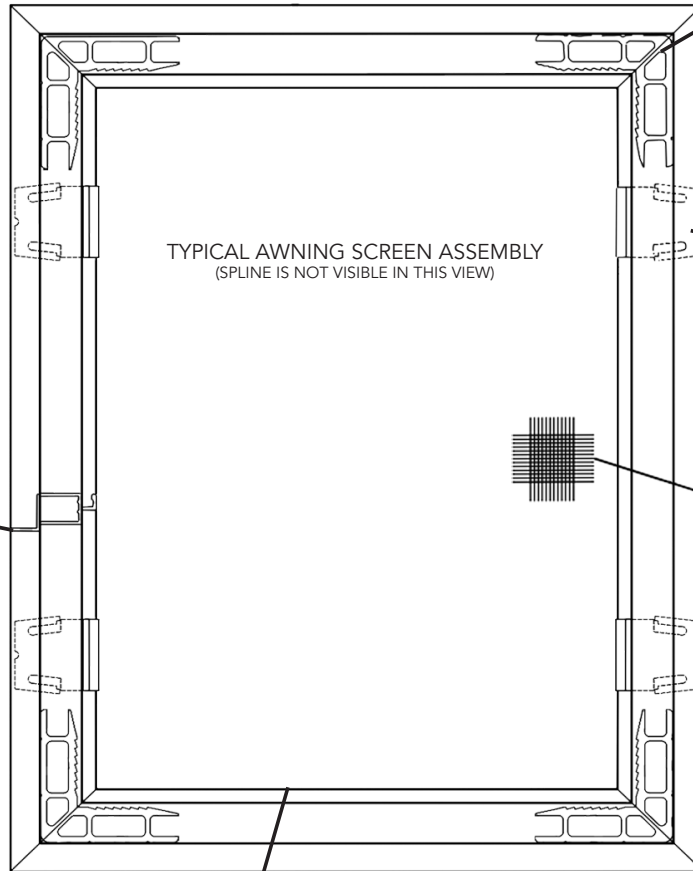
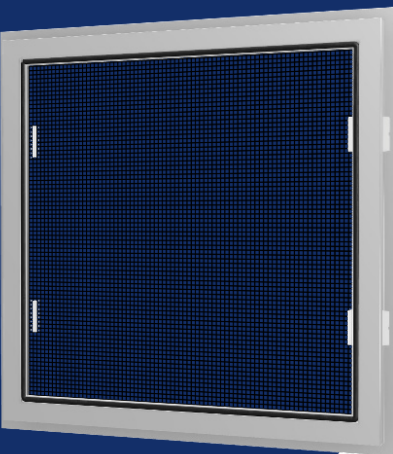

Only available in 7/16"

Standard Colors:

XXX in part numbers are
placeholders for Color Code

White (C01)



Almond (A29)

Black (L48)

Clay (A22)

Bronze (B16)

Series #	Fully Assembled Screen	Size	UOM	List Price
CA4	Minimum Price	0" to 49" UI	United Inch	\$44.14
CA4	U.I. Price	50" UI and Above	United Inch	\$0.9010

Part #	Description	Color	Length	UOM	QTY	List Price
EA38654-150-XXX	Casement Frame	Standard	12.5'	Box	20/pcs	\$935.66
XCR54663-328-IS**	Inside Corner	Mill		Box	100/pcs	\$110.34
XHW1025-XXX**	Plastic Side Latch	White or Black		Box	100/pcs	\$92.56
MSFG36X100-L00	36" x 100' Char Fiber Mesh	Charcoal	100'	Roll	400 ft ²	\$184.80
SPFRD140-BX-L	Foam Spline	Black	8,000'	Box	8,000'	\$556.80

**Available in bulk quantities

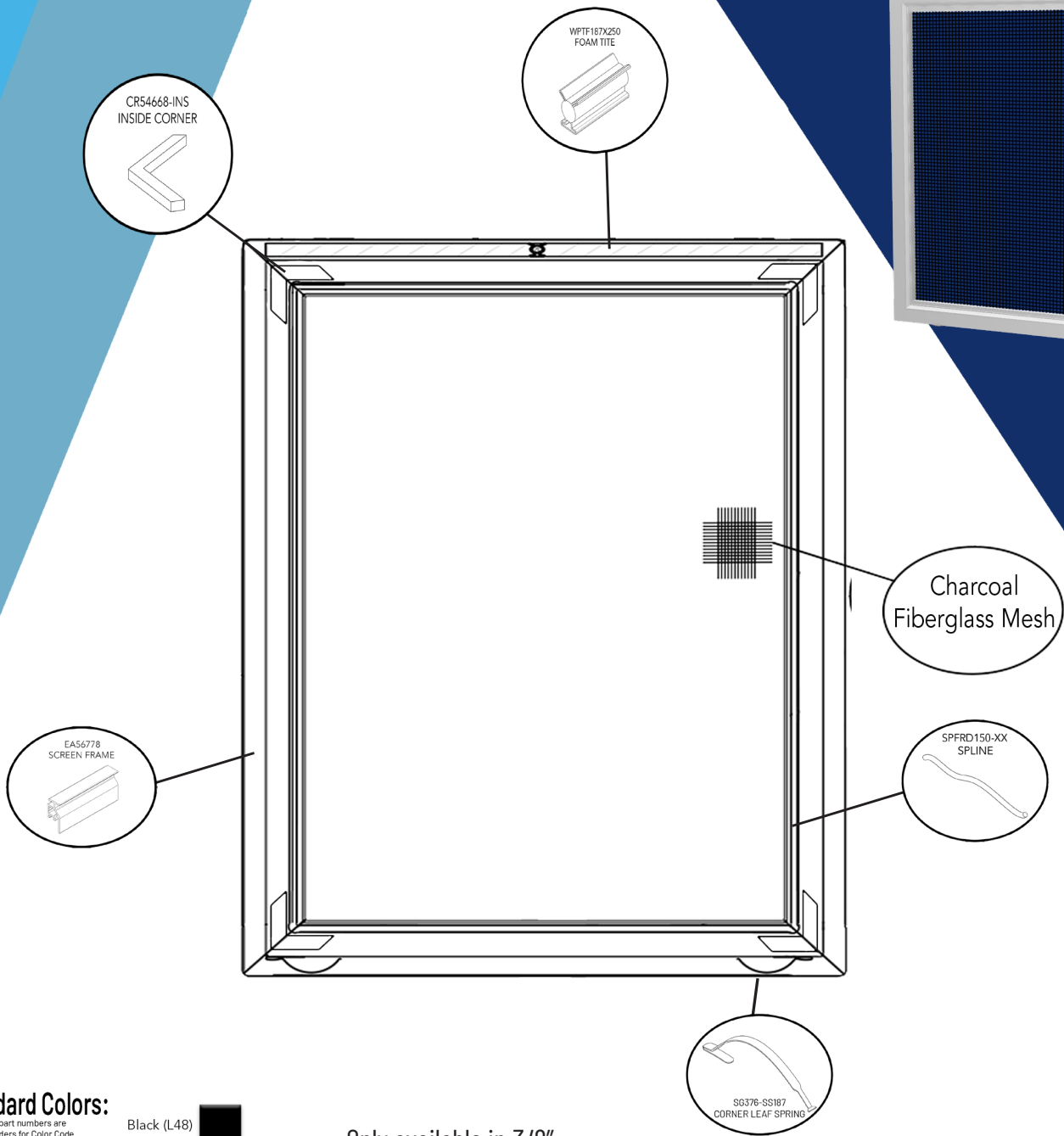

Standard Colors:

XXX in part numbers are place holders for Color Code

Black (L48)	
White (C01)	
Almond (A29)	
Clay (A22)	
Bronze (B16)	

Only available in 3/8"

Series #	Fully Assembled Screen	Size	UOM	List Price
CA5	Minimum Price	0" to 49" UI	United Inch	\$45.00
CA5	U.I. Price	50" UI and Above	United Inch	\$,9814

Part #	Description	Color	Length	UOM	QTY	List Price
EA56778-150-XXX	Casement Frame	Standard	12.5'	Box	20/pcs	\$797.28
XCR54668-INS**	Inside Corner	Mill		Box	100/pcs	\$111.74
WPTF187X250	Woolpile Foam, T-Slot	Natural	1000'	Box	1000'	\$1012.00
XSG376-SS187**	Corner Leaf Spring	Mill		Box	100/pcs	\$165.60
MSFG36X100-L00	36" x 100' Char Fiber Mesh	Charcoal	100'	Roll	400 ft ²	\$184.80
SPFRD150-BX-L	.150" Foam Spline	Black	8,000'	Box	8,000'	\$491.04

**Available in bulk quantities

WK1 - Extruded Hinged Wicket

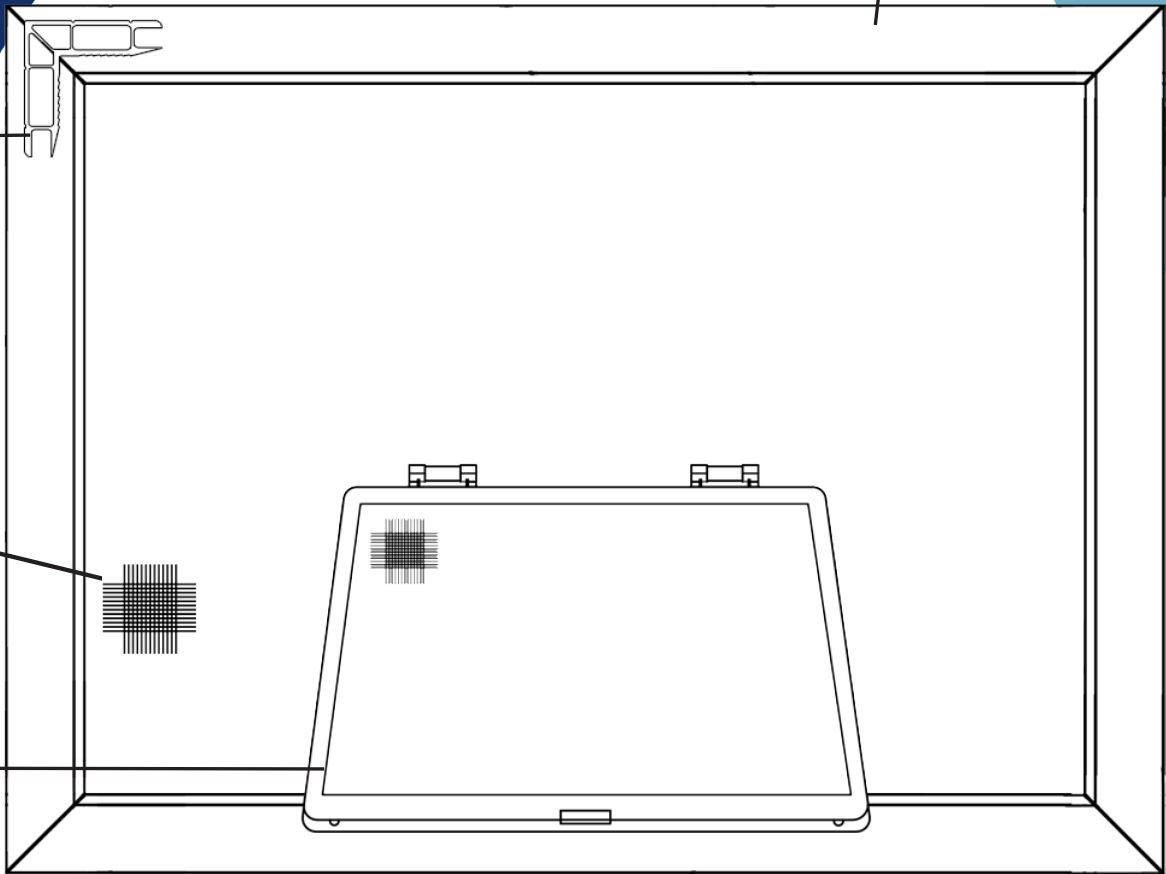
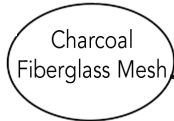
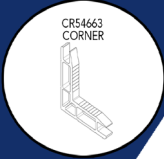
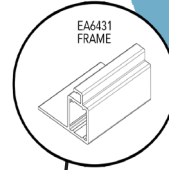
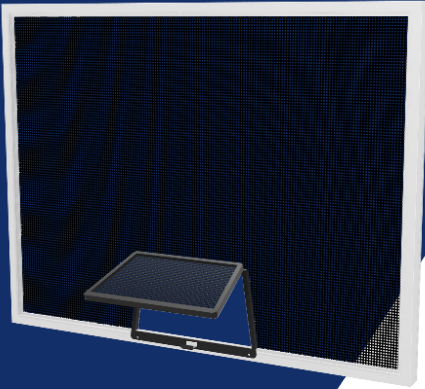

Standard Colors:

XXX in part numbers are place holders for Color Code



Series #	Fully Assembled Screen	Size	UOM	List Price
WK1	Minimum Price	0" to 49" UI	United Inch	\$81.80
WK1	U.I. Price	50" UI and Above	United Inch	\$1.6692
	Additional Wicket Cost		Per Wicket	+\$16.72

Part #	Description	Color	Length	UOM	QTY	List Price
WEA6431-150-XXX	Stand-off Frame	Standard	12.5'	Box	20/pcs	\$1128.60
XCR54663-328-IS**	Corner	Mill		Box	100/pcs	\$110.34
WK828-B-X	Wicket	Black		Box	200	\$2,147.20
MSFG36X100-L00	36" x 100' Char Fiber Mesh	Charcoal	100'	Roll	400 ft ²	\$184.80

**Available in bulk quantities

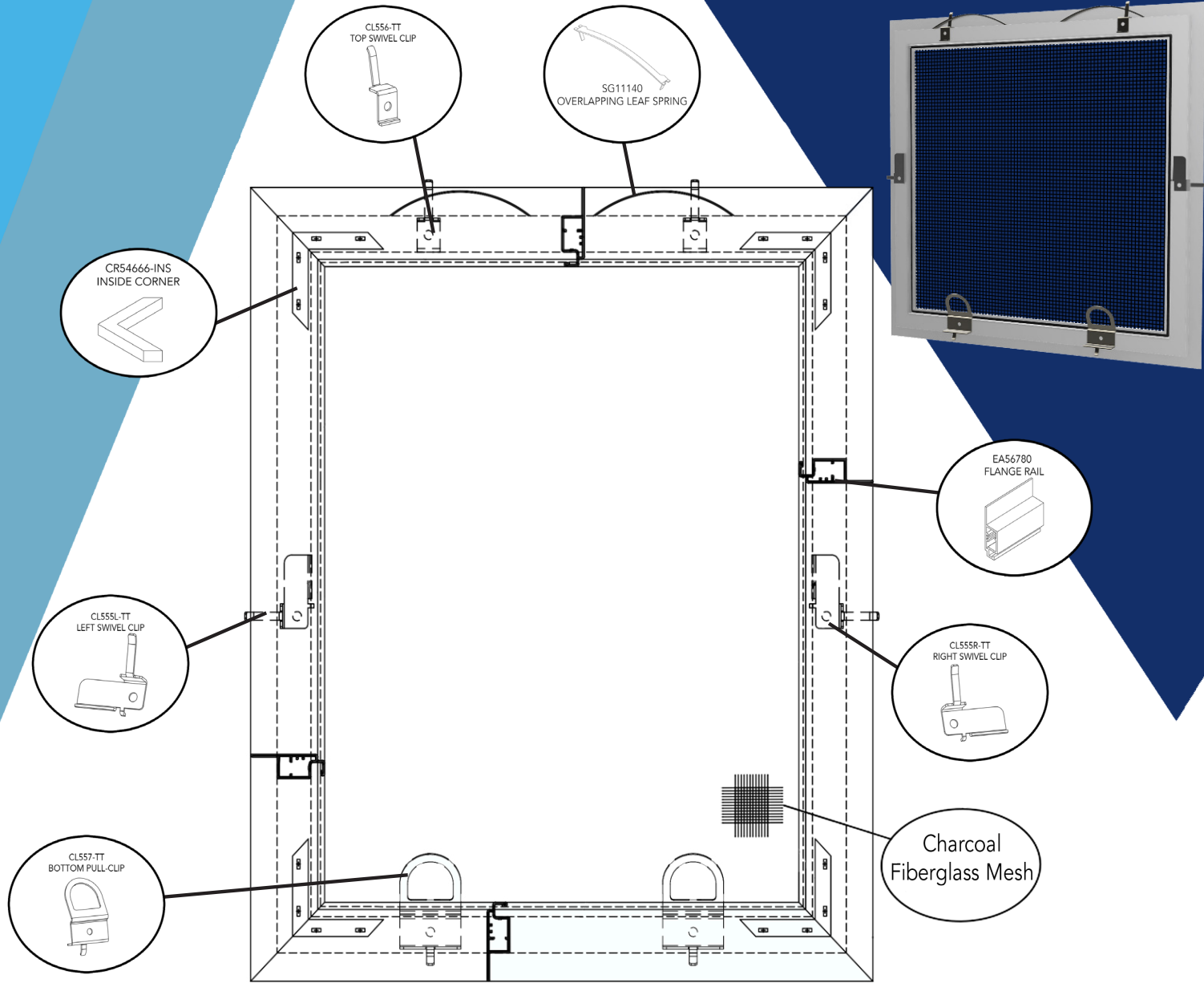

AVAILABLE COLORS

XXX in part numbers are
place holders for Color Code



White (C01) Bronze (B16)

Series #	Fully Assembled Screen	Size	UOM	List Price
RS-505223	Minimum Price	0" to 49" UI	United Inch	\$75.55
RS-505223	U.I. Price	50" UI and Above	United Inch	\$1,541.9

Part #	Description	Color	Length	UOM	QTY	List Price
EA56780-150-XXX	Flange Rail	Standard	12.5'	Box	20/pcs	\$878.02
XCR54666-INS	Inside Corner	Mill		Box	100/pcs	\$124.94
XCL556-TT	Top Swivel Clip	Mill		Box	100/pcs	\$293.20
XCL555R/L-TT	Right/Left Swivel Clip	Mill		Box	100/pcs	\$319.60
XSG11140**	Overlapping Leaf Spring	Mill		Box	100/pcs	\$113.94
XCL557-TT	Bottom Pull-Clip	Mill		Box	100/pcs	\$454.24
MSFG36X100-L00	36" x 100' Char Fiber Mesh	Charcoal	100'	Roll	400 ft ²	\$184.80
SPFRD150-BX-L	.150" Foam Spline	Black	8,000'	Box	8,000'	\$491.04

**Available in bulk quantities

RS-505224 Tilt & Turn w/ Plungers

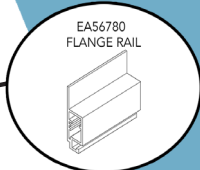
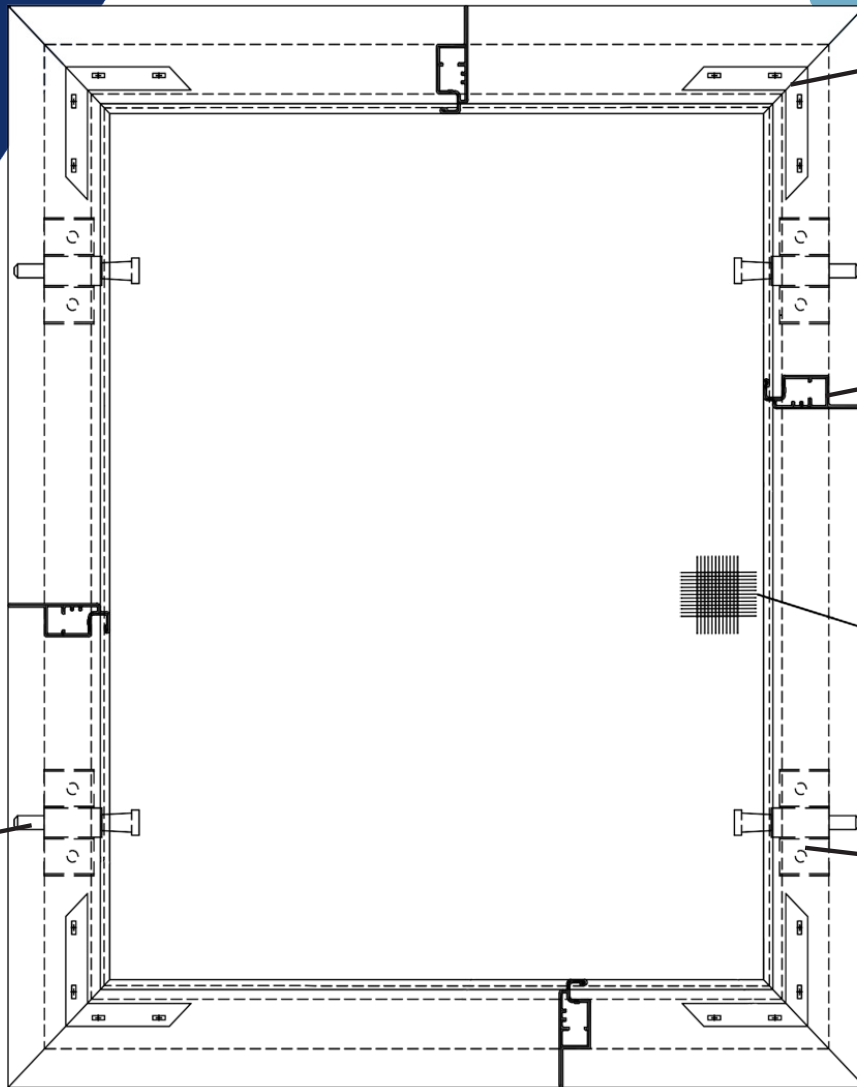
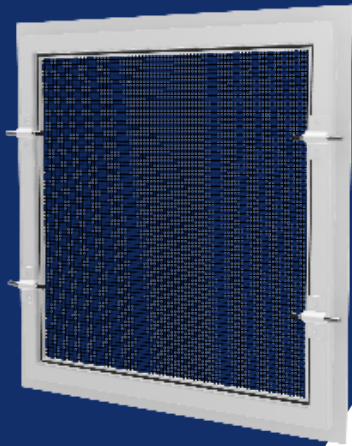

AVAILABLE COLORS

XXX in part numbers are
place holders for Color Code



Series #	Fully Assembled Screen	Size	UOM	List Price
RS-505224	Minimum Price	0" to 49" UI	United Inch	\$64.19
RS-505224	U.I. Price	50" UI and Above	United Inch	\$1.3101

Part #	Description	Color	Length	UOM	QTY	List Price
EA56780-150-XXX	Casement Frame	Standard	12.5'	Box	20/pcs	\$797.28
XCR54666-INS	Inside Corner	Mill		Box	100/pcs	\$124.94
XCL3420-XXX	Plunger Housing	White or Bronze		Box	100/pcs	\$148.00
PL315/SG412/PL308-XXX	Plunger Assembly	See Component Section for Pricing				
MSFG36X100-L00	36" x 100' Char Fiber Mesh	Charcoal	100'	Roll	400 ft ²	\$184.80
SPFRD150-BX-L	.150" Foam Spline	Black	8,000'	Box	8,000'	\$491.04

**Available in bulk quantities

At Ritescreen, our unwavering commitment to innovation ensures that we continually update our top-of-the-line GenExt screens to provide cutting-edge solutions for a wide range of applications.

Always stay up-to-date with
RiteScreen & GenExt
1-800-949-4174
www.RITESCREEN.com
insidesales@ritescreen.com



75
YEARS

Innovation Weaved Into Every Strand



ROLL-FORMED WINDOW SCREENS



A woman with blonde hair in a ponytail, wearing a beige cardigan and blue jeans, is sitting on a white toilet in a bathroom. She is looking out a window to the left. The background shows a window with greenery outside and a dark cabinet with a basket on top to the right.

Our roll-formed screen frame was developed by RiteScreen engineers and is shaped in-house.

RFSH1 - Roll-Formed Single Hung Screen

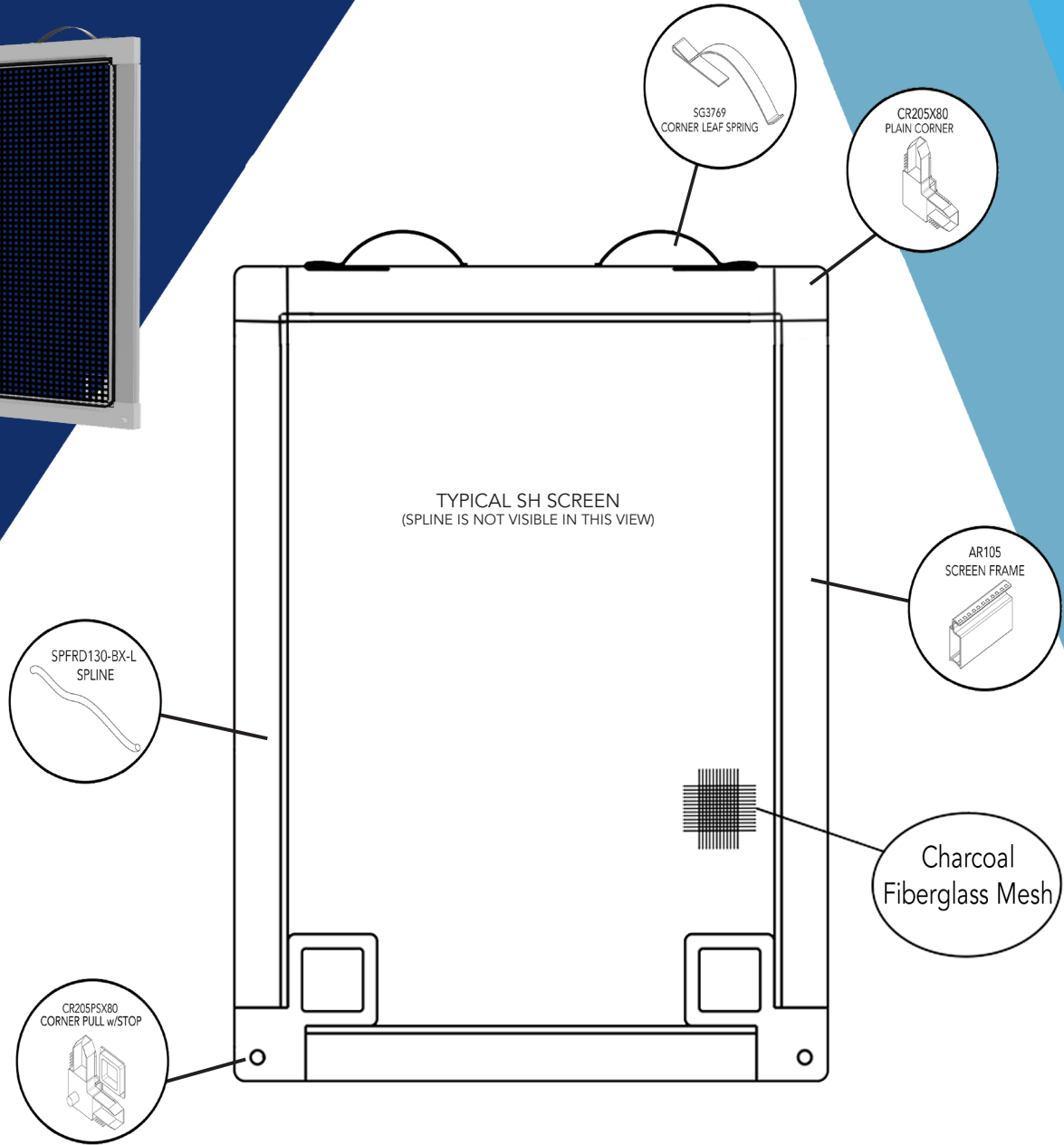
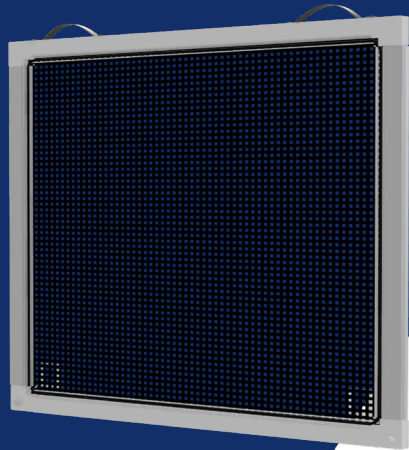

Shown in $\frac{5}{16}$ ". Also available in $\frac{3}{8}$ " and $\frac{7}{16}$ ", contact RiteScreen for details.

Standard Colors:

XXX in part numbers are place holders for Color Code

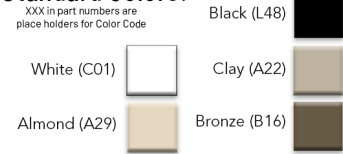

Series #	Fully Assembled Screen	Size	UOM	List Price
RFSH1	Minimum Price	0" to 49" UI	United Inch	\$22.58
RFSH1	U.I. Price	50" UI and Above	United Inch	\$0.4608
RFSH1-W	With Woolpile	50" UI and Above	United Inch	\$0.5174

Part #	Description	Color	Length	UOM	QTY	List Price
AR105-16-12XXX	Screen Frame	Standard	12.5'	Box	152/pcs	\$1,583.72
XCR205X80-XXX**	Plain Corner	Standard		Box	100/pcs	\$77.68
XCR205PSX80-XXX**	Corner Pull w/Stop	Standard		Box	100/pcs	\$83.76
XSG3769**	Leaf Spring	Mill		Box	100/pcs	\$88.96
MSFG36X100-L00	36" x 100' Char Fiber Mesh	Charcoal	100'	Roll	400 ft ²	\$184.80
SPFRD130-BX-L	Foam Spline	Black	8,000'	Box	8,000'	\$369.60

**Available in bulk quantities

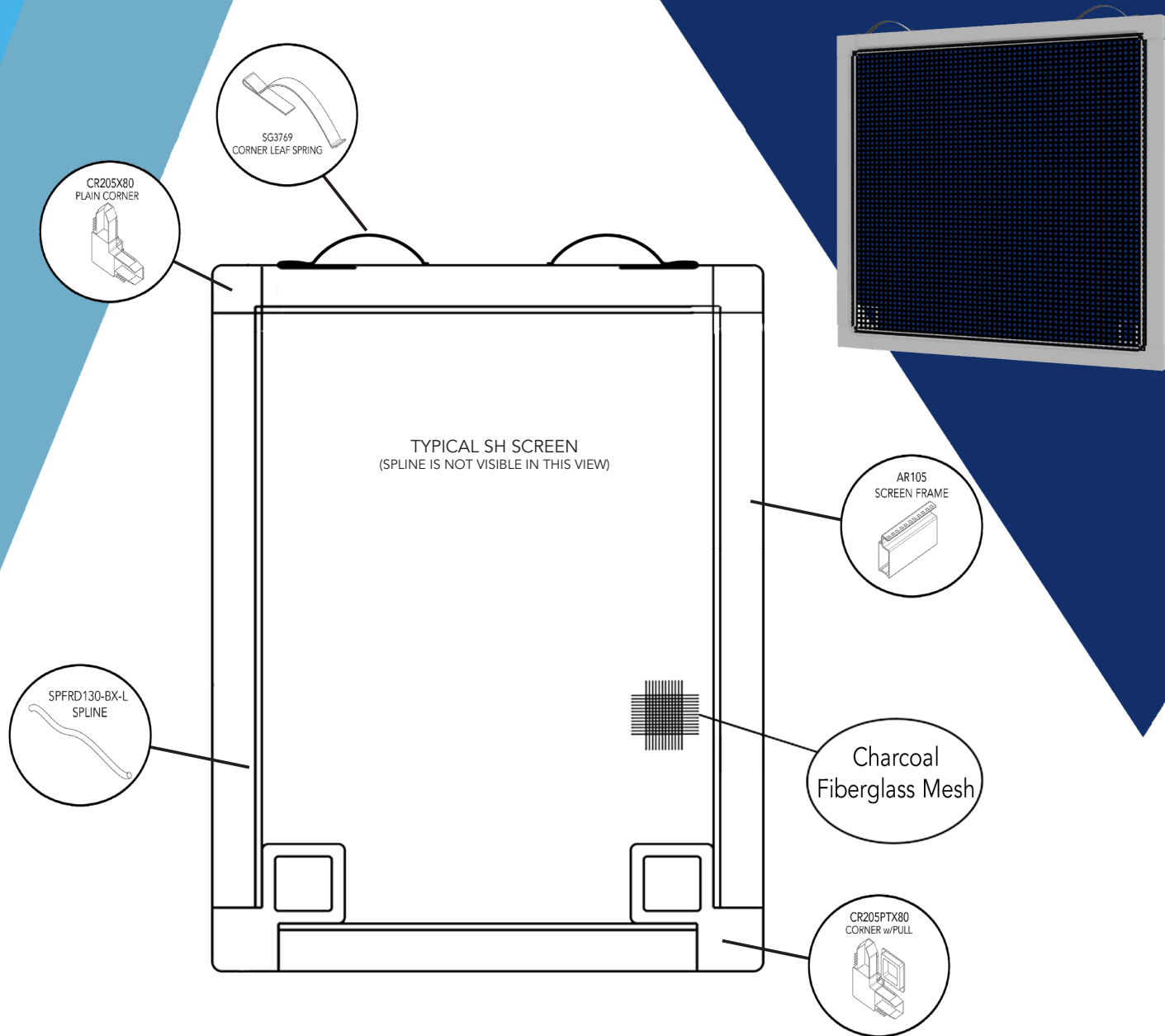

Standard Colors:

XXX in part numbers are place holders for Color Code



Shown in $\frac{5}{16}$ ". Also available in $\frac{3}{8}$ " and $\frac{7}{16}$ ", contact RiteScreen for details.

Series #	Fully Assembled Screen	Size	UOM	List Price
RFSH2	Minimum Price	0" to 49" UI	United Inch	\$22.58
RFSH2	U.I. Price	50" UI and Above	United Inch	\$0.4608
RFSH2-W	With Woolpile	50" UI and Above	United Inch	\$0.5174

Part #	Description	Color	Length	UOM	QTY	List Price
AR105-16-12XXX	Screen Frame	Standard	12.5'	Box	152/pcs	\$1,583.72
XCR205X80-XXX**	Plain Corner	Standard		Box	100/pcs	\$77.68
XCR205PTX80-XXX**	Corner w/Pull	Standard		Box	100/pcs	\$83.58
XSG3769**	Leaf Spring	Mill		Box	100/pcs	\$88.96
MSFG36X100-L00	36" x 100' Char Fiber Mesh	Charcoal	100'	Roll	400 ft ²	\$184.80
SPFRD130-BX-L	Foam Spline	Black	8,000'	Box	8,000'	\$369.60

**Available in bulk quantities

RFSH3 - Roll-Formed Single Hung Screen

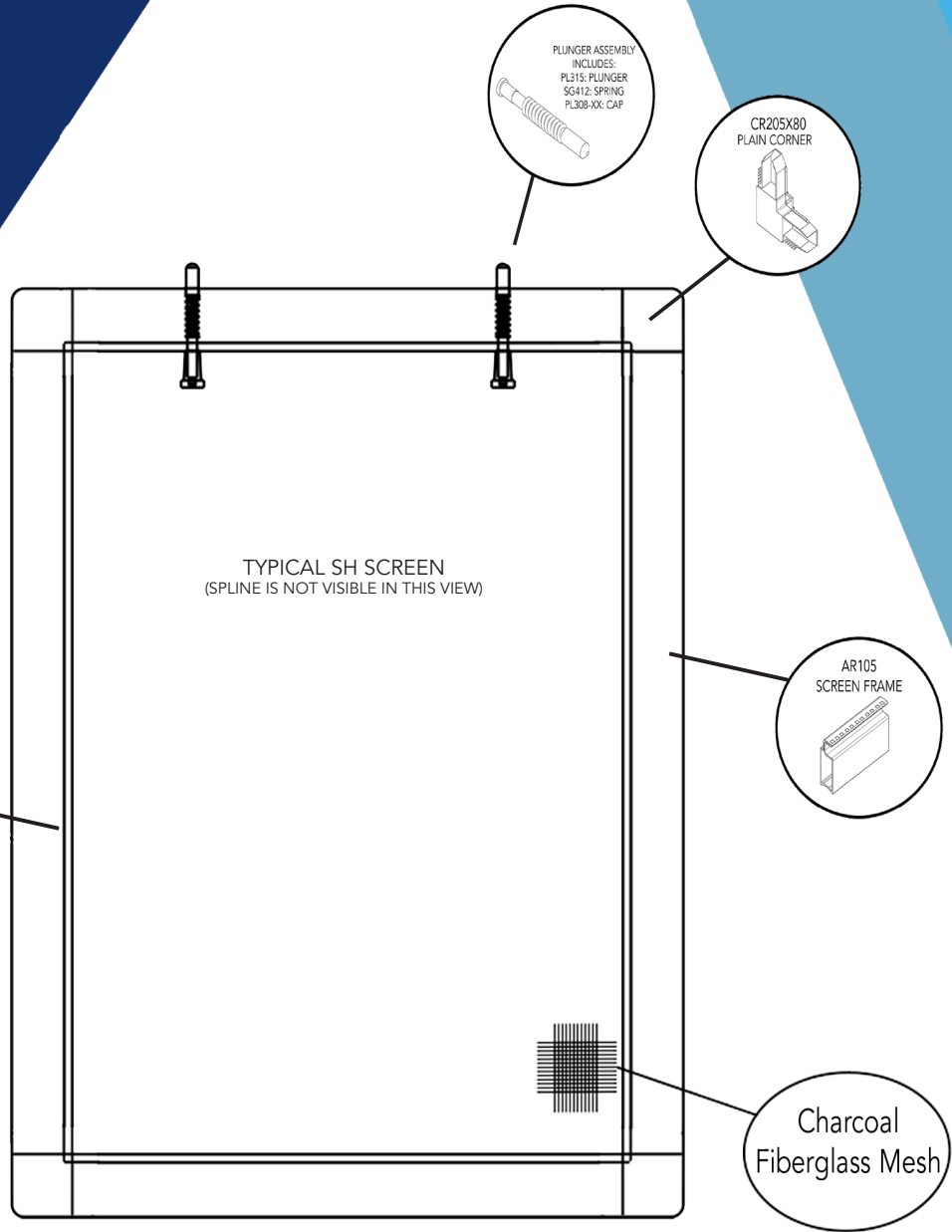
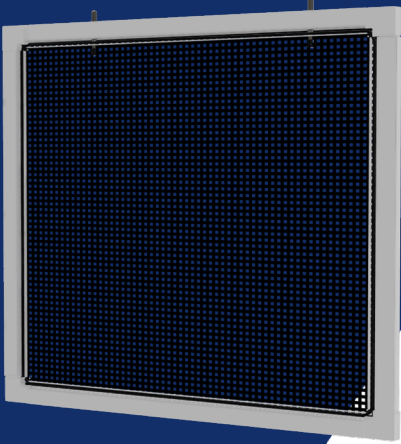

Shown in $\frac{5}{16}$ ". Also available in $\frac{3}{8}$ " and $\frac{7}{16}$ ", contact RiteScreen for details.

Standard Colors:

XXX in part numbers are place holders for Color Code

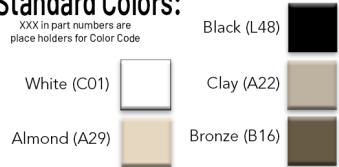

Series #	Fully Assembled Screen	Size	UOM	List Price
RFSH3	Minimum Price	0" to 49" UI	United Inch	\$22.96
RFSH3	U.I. Price	50" UI and Above	United Inch	\$0.4688
RFSH3-W	With Woolpile	50" UI and Above	United Inch	\$0.5254

Part #	Description	Color	Length	UOM	QTY	List Price
AR105-16-12XXX	Screen Frame	Standard	12.5'	Box	152/pcs	\$1,583.72
XCR205X80-XXX**	Plain Corner	Standard		Box	100/pcs	\$77.68
PL315/SG412/PL308-XXX	Plunger Assembly	See Component Section for Pricing				
SPFRD130-BX-L	Foam Spline	Black	8,000'	Box	8,000'	\$369.60
MSFG36X100-L00	36" x 100' Char Fiber Mesh	Charcoal	100'	Roll	400 ft ²	\$184.80

**Available in bulk quantities

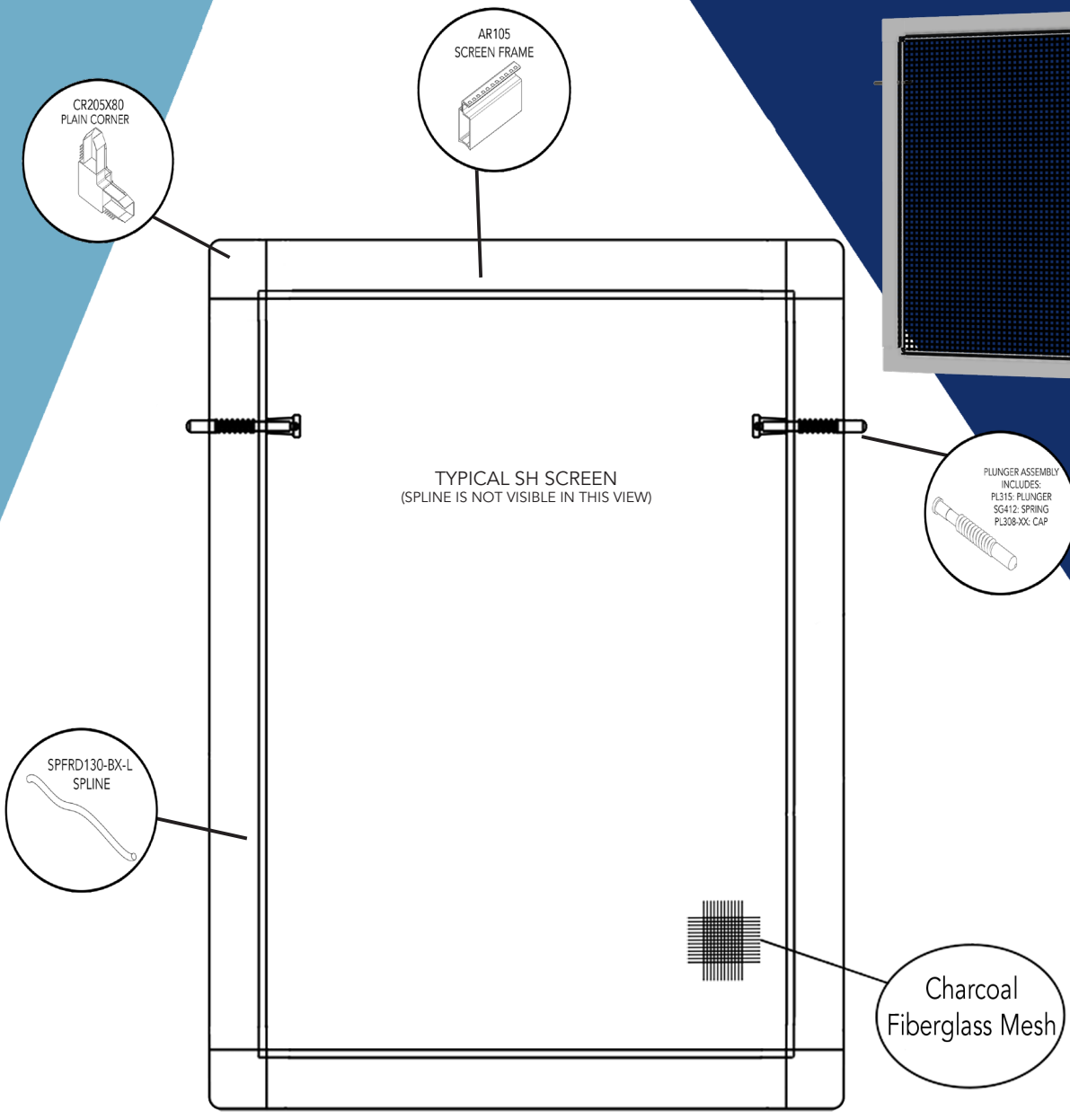

Standard Colors:

XXX in part numbers are place holders for Color Code



Shown in $\frac{5}{16}$ ". Also available in $\frac{3}{8}$ " and $\frac{7}{16}$ ", contact RiteScreen for details.

Series #	Fully Assembled Screen	Size	UOM	List Price
RFSH4	Minimum Price	0" to 49" UI	United Inch	\$22.96
RFSH4	U.I. Price	50" UI and Above	United Inch	\$0.4688
RFSH4-W	With Woolpile	50" UI and Above	United Inch	\$0.5254

Part #	Description	Color	Length	UOM	QTY	List Price
AR105-16-12XXX	Screen Frame	Standard	12.5'	Box	152/pcs	\$1,583.72
XCR205X80-XXX**	Plain Corner	Standard		Box	100/pcs	\$77.68
PL315/SG412/PL308-XXX	Plunger Assembly		See Component Section for Pricing			
SPFRD130-BX-L	Foam Spline	Black	8,000'	Box	8,000'	\$369.60
MSFG36X100-L00	36" x 100' Char Fiber Mesh	Charcoal	100'	Roll	400 ft ²	\$184.80

**Available in bulk quantities

RFSH5 - Roll-Formed Single Hung Screen

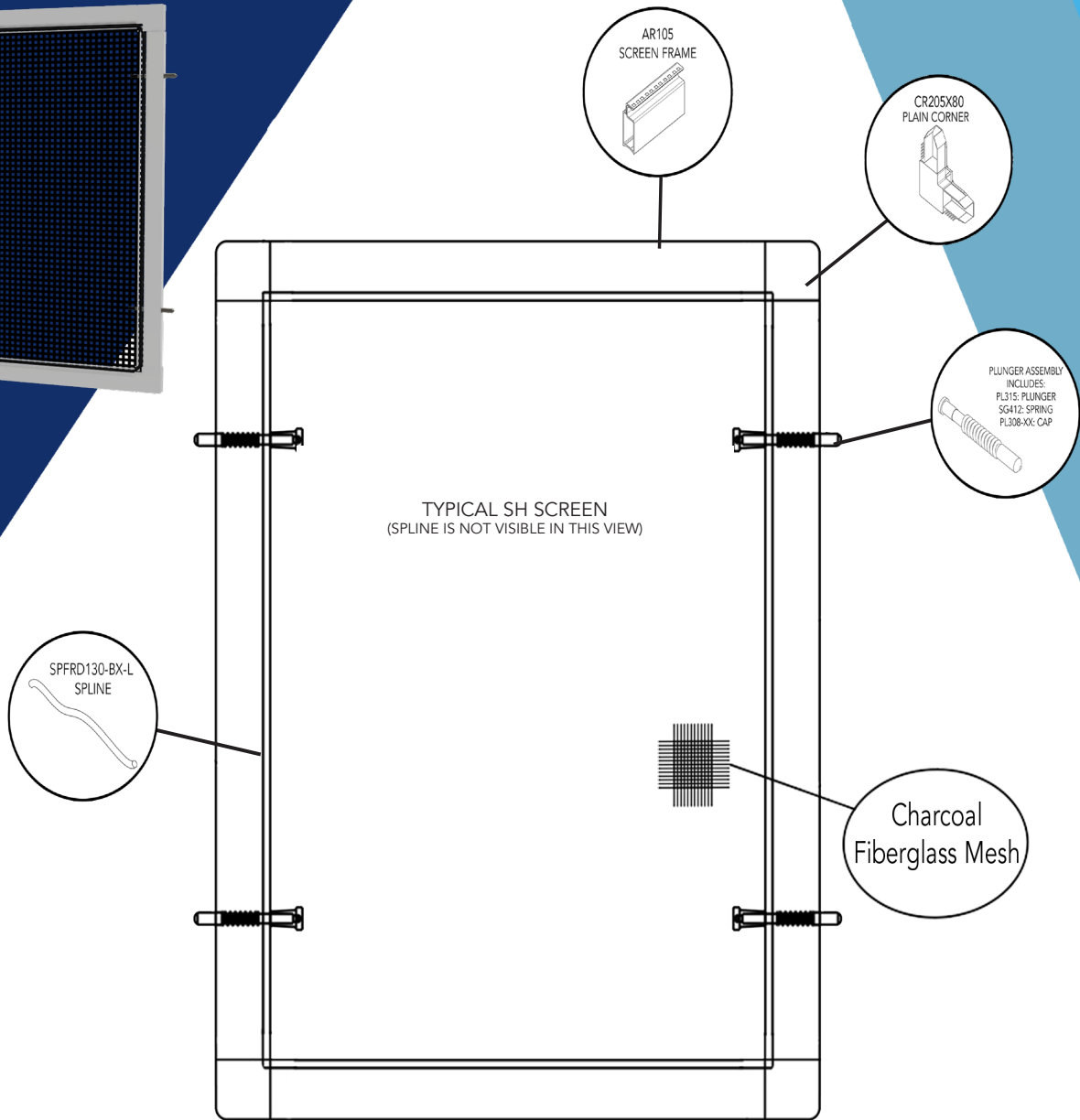
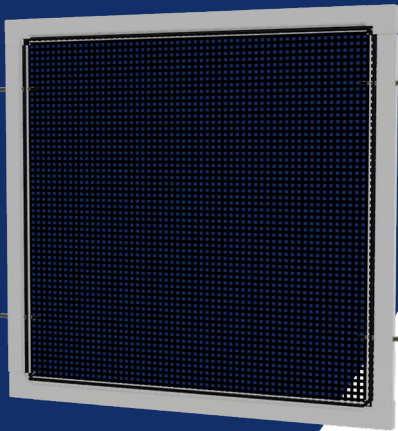

Shown in $\frac{5}{16}$ ". Also available in $\frac{3}{8}$ " and $\frac{7}{16}$ ", contact RiteScreen for details.

Standard Colors:

XXX in part numbers are place holders for Color Code

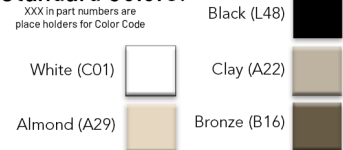

Series #	Fully Assembled Screen	Size	UOM	List Price
RFSH5	Minimum Price	0" to 49" UI	United Inch	\$23.90
RFSH5	U.I. Price	50" UI and Above	United Inch	\$0.4878

Part #	Description	Color	Length	UOM	QTY	List Price
AR105-16-12XXX	Screen Frame	Standard	12.5'	Box	152/pcs	\$1,583.72
XCR205X80-XXX**	Plain Corner	Standard		Box	100/pcs	\$77.68
PL315/SG412/PL308-XXX	Plunger Assembly	See Component Section for Pricing				
SPFRD130-BX-L	Foam Spline	Black	8,000'	Box	8,000'	\$369.60
MSFG36X100-L00	36" x 100' Char Fiber Mesh	Charcoal	100'	Roll	400 ft ²	\$184.80

** Available in bulk quantities

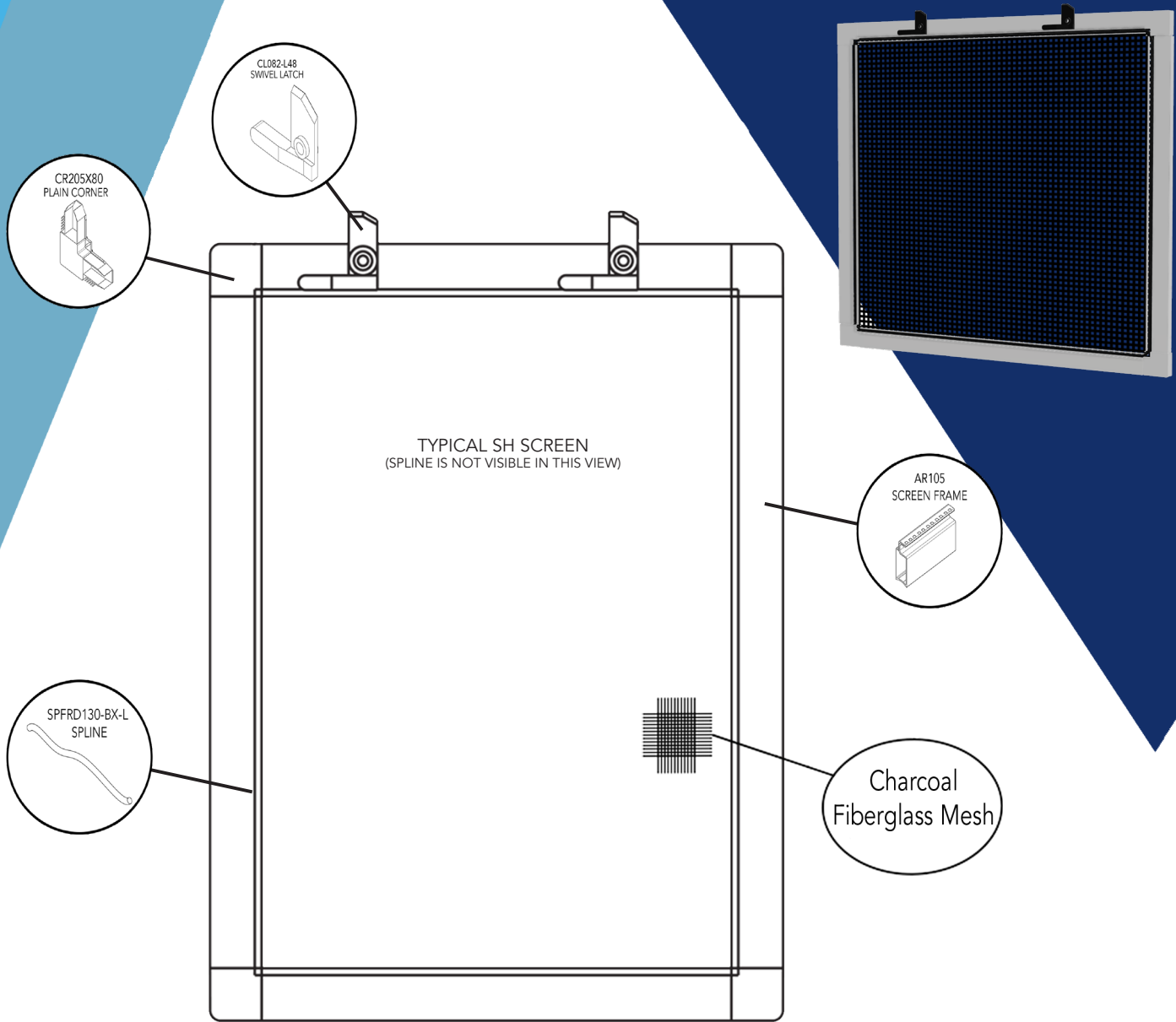

Standard Colors:

XXX in part numbers are place holders for Color Code



Shown in $\frac{5}{16}$ ". Also available in $\frac{3}{8}$ " and $\frac{7}{16}$ ", contact RiteScreen for details.

Series #	Fully Assembled Screen	Size	UOM	List Price
RFSH6	Minimum Price	0" to 49" UI	United Inch	\$22.72
RFSH6	U.I. Price	50" UI and Above	United Inch	\$0.4634

Part #	Description	Color	Length	UOM	QTY	List Price
AR105-16-12XXX	Screen Frame	Standard	12.5'	Box	152/pcs	\$1,583.72
XCR205X80-XXX**	Plain Corner	Standard		Box	100/pcs	\$77.68
XCL082-L48**	Swivel Latch	Black		Box	100/pcs	\$96.96
SPFRD130-BX-L	Foam Spline	Black	8,000'	Box	8,000'	\$369.60
MSFG36X100-L00	36" x 100' Char Fiber Mesh	Charcoal	100'	Roll	400 ft ²	\$184.80

**Available in bulk quantities

RFSH7 - Roll-Formed Single Hung Screen

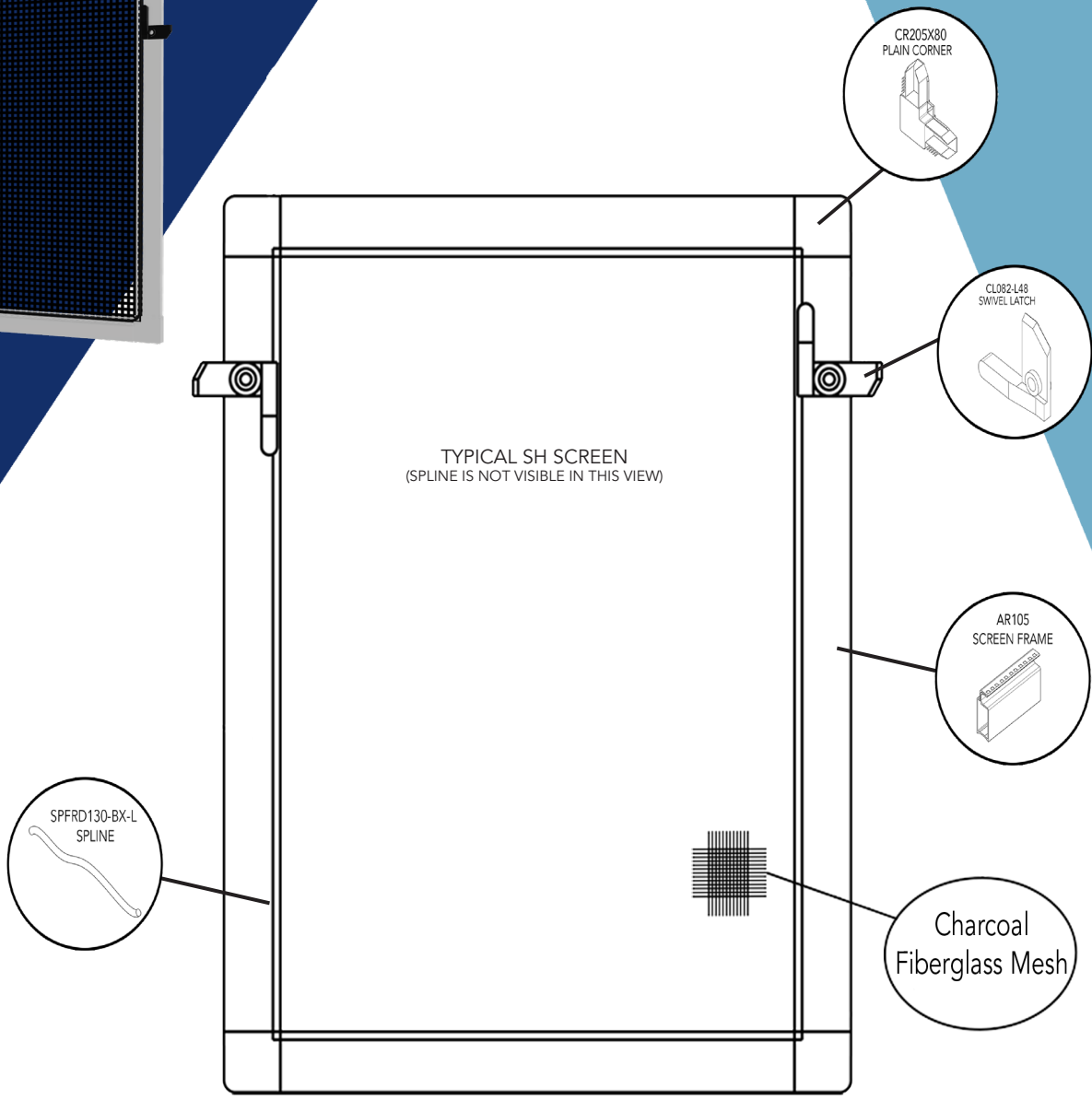
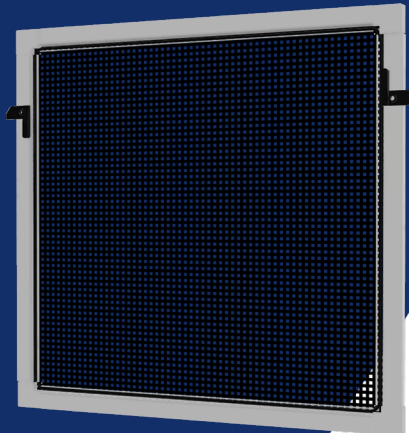

Shown in $\frac{5}{16}$ ". Also available in $\frac{3}{8}$ " and $\frac{7}{16}$ ", contact RiteScreen for details.

Standard Colors:

XXX in part numbers are place holders for Color Code



Series #	Fully Assembled Screen	Size	UOM	List Price
RFSH7	Minimum Price	0" to 49" UI	United Inch	\$22.72
RFSH7	U.I. Price	50" UI and Above	United Inch	\$0.4634

Part #	Description	Color	Length	UOM	QTY	List Price
AR105-16-12XXX	Screen Frame	Standard	12.5'	Box	152/pcs	\$1,583.72
XCR205X80-XXX**	Plain Corner	Standard		Box	100/pcs	\$77.68
XCL082-L48**	Swivel Latch	Black		Box	100/pcs	\$96.96
SPFRD130-BX-L	Foam Spline	Black	8,000'	Box	8,000'	\$369.60
MSFG36X100-L00	36" x 100' Char Fiber Mesh	Charcoal	100'	Roll	400 ft ²	\$184.80

**Available in bulk quantities

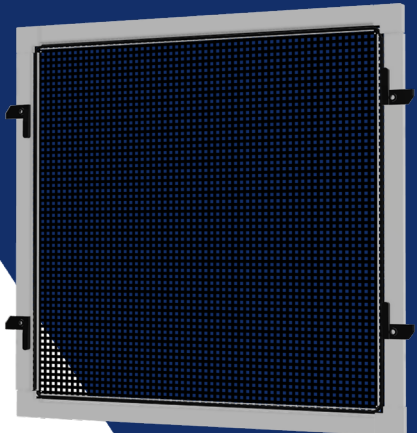
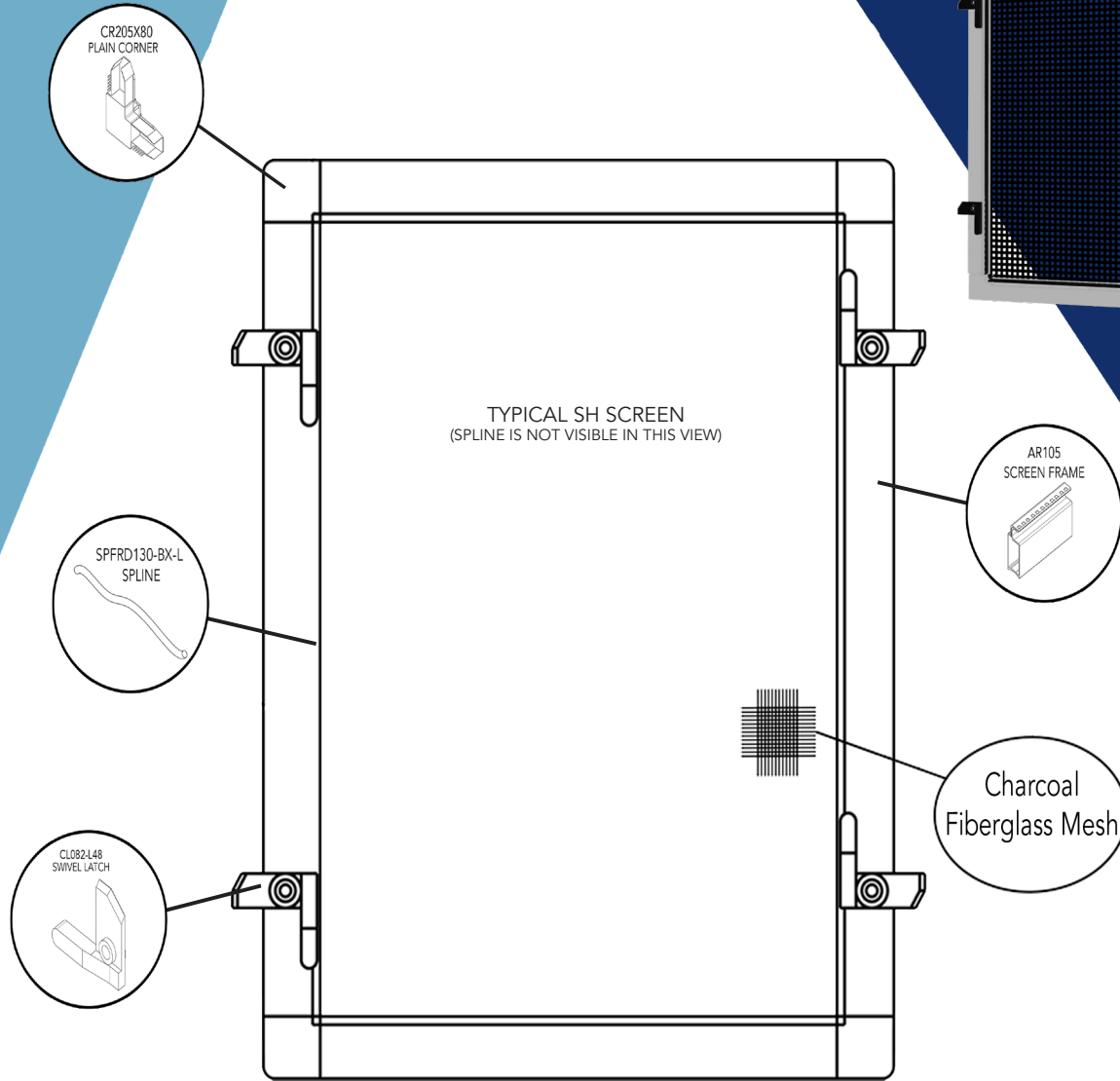

Standard Colors:

XXX in part numbers are place holders for Color Code

Black (L48)	
White (C01)	
Almond (A29)	
Clay (A22)	
Bronze (B16)	

Shown in $\frac{5}{16}$ ". Also available in $\frac{3}{8}$ " and $\frac{7}{16}$ ", contact RiteScreen for details.

Series #	Fully Assembled Screen	Size	UOM	List Price
RFSH8	Minimum Price	0" to 49" UI	United Inch	\$23.38
RFSH8	U.I. Price	50" UI and Above	United Inch	\$0.4772

Part #	Description	Color	Length	UOM	QTY	List Price
AR105-16-12XXX	Screen Frame	Standard	12.5'	Box	152/pcs	\$1,583.72
XCR205X80-XXX**	Plain Corner	Standard		Box	100/pcs	\$77.68
XCL082-L48**	Swivel Latch	Black		Box	100/pcs	\$96.96
SPFRD130-BX-L	Foam Spline	Black	8,000'	Box	8,000'	\$369.60
MSFG36X100-L00	36" x 100' Char Fiber Mesh	Charcoal	100'	Roll	400 ft ²	\$184.80

**Available in bulk quantities

RFSH9 - Roll-Formed Single Hung Screen

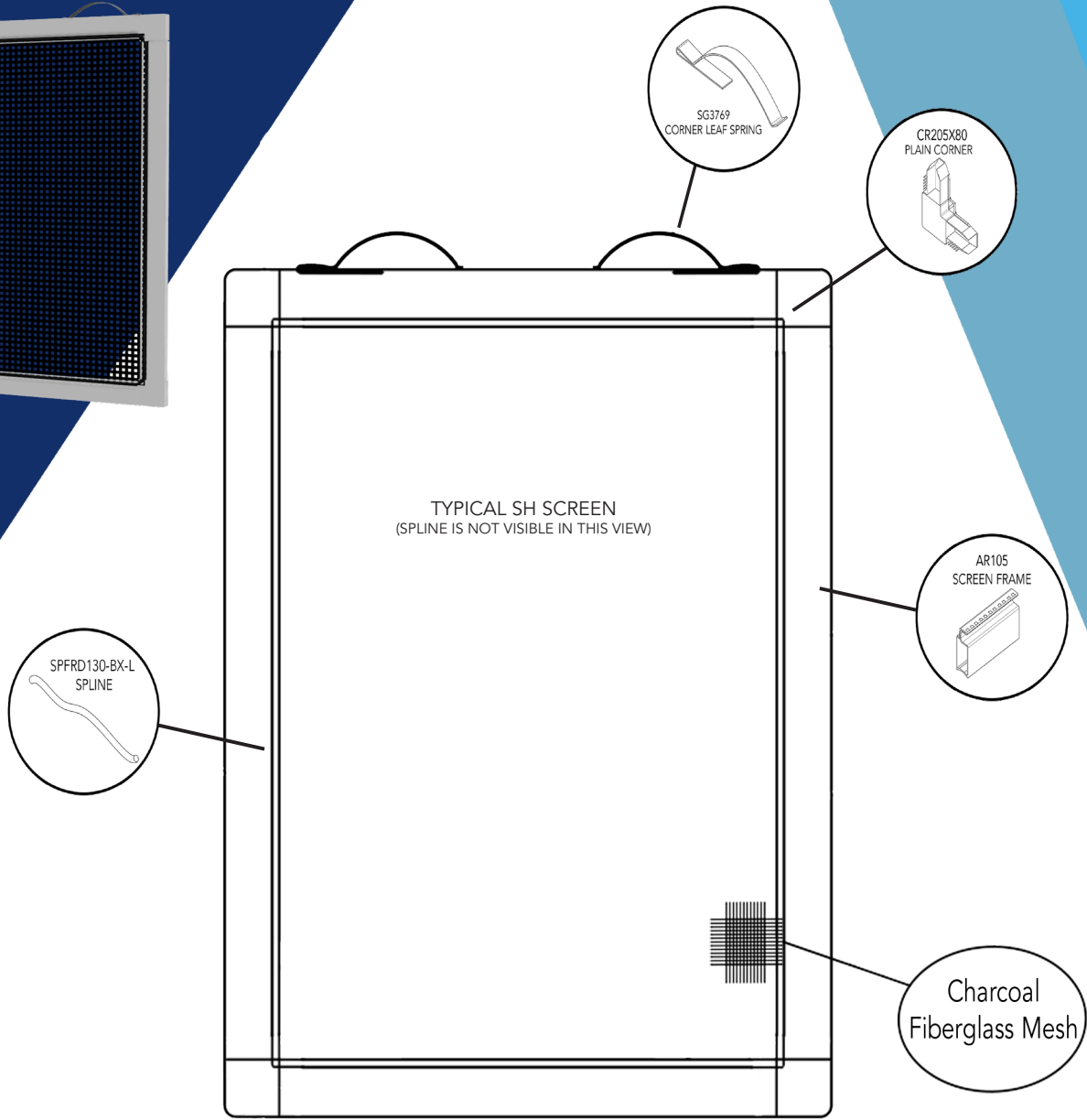
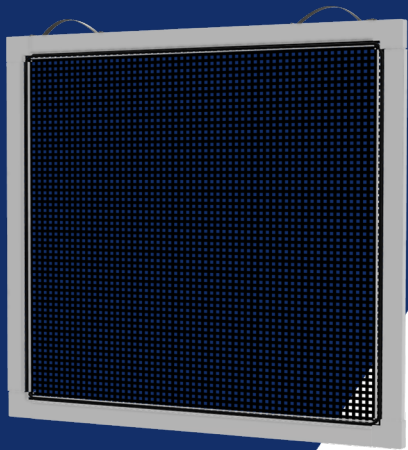

Shown in $\frac{5}{16}$ ". Also available in $\frac{3}{8}$ " and $\frac{7}{16}$ ", contact RiteScreen for details.

Standard Colors:

XXX in part numbers are place holders for Color Code



Series #	Fully Assembled Screen	Size	UOM	List Price
RFSH9	Minimum Price	0" to 49" UI	United Inch	\$22.58
RFSH9	U.I. Price	50" UI and Above	United Inch	\$0.4608

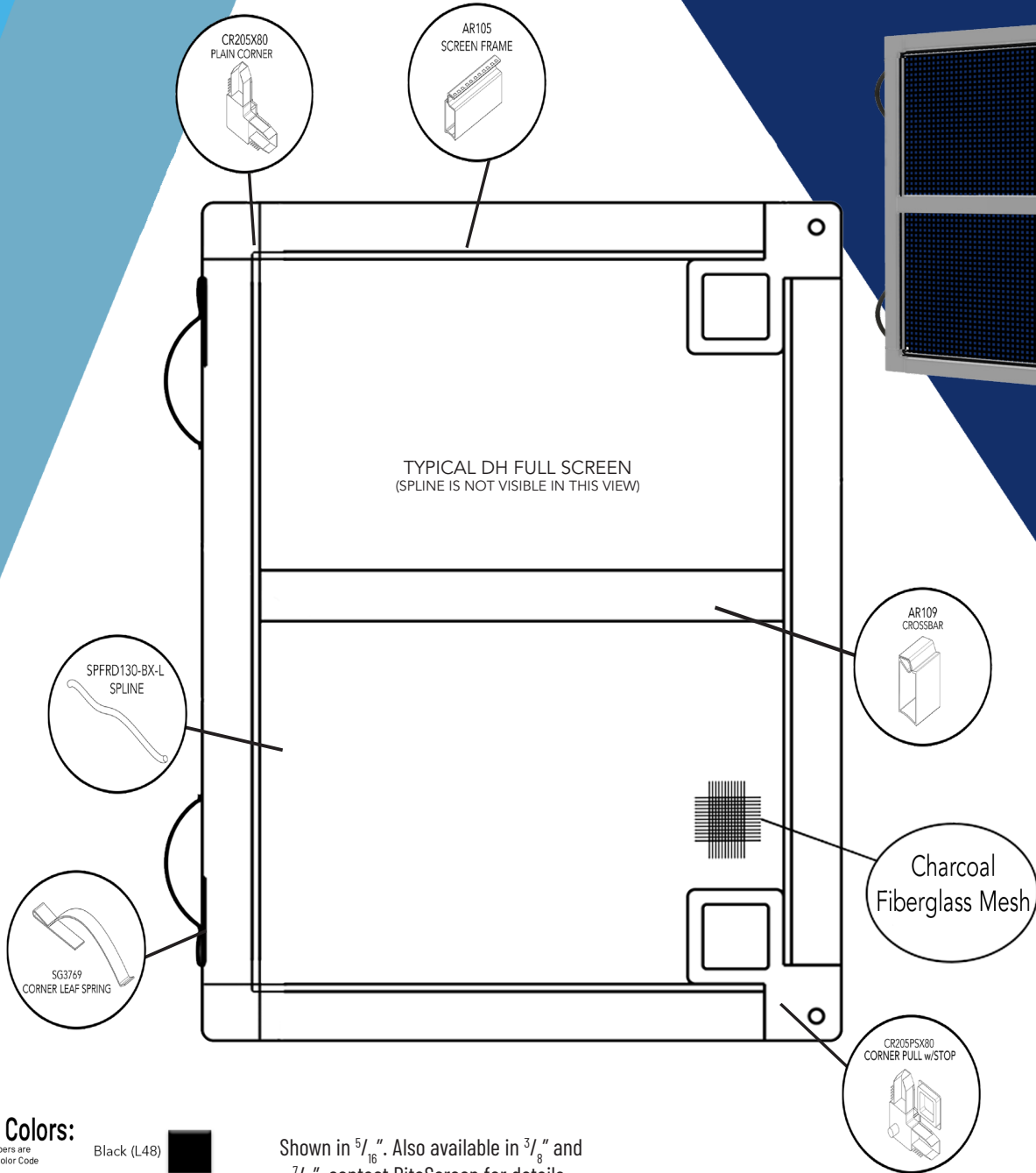

Part #	Description	Color	Length	UOM	QTY	List Price
AR105-16-12XXX	Screen Frame	Standard	12.5'	Box	152/pcs	\$1,583.72
XCR205X80-XXX**	Plain Corner	Standard		Box	100/pcs	\$77.68
XSG3769**	Leaf Spring	Mill		Box	100/pcs	\$88.96
MSFG36X100-L00	36" x 100' Char Fiber Mesh	Charcoal	100'	Roll	400 ft ²	\$184.80
SPFRD130-BX-L	Foam Spline	Black	8,000'	Box	8,000'	\$369.60

**Available in bulk quantities



Standard Colors:

XXX in part numbers are
placeholders for Color Code

Black (L48)	
White (C01)	
Clay (A22)	
Almond (A29)	
Bronze (B16)	

Shown in $\frac{5}{16}$ ". Also available in $\frac{3}{8}$ " and $\frac{7}{16}$ ", contact RiteScreen for details.

Series #	Fully Assembled Screen	Size	UOM	List Price
RFDH1	Minimum Price	0" to 49" UI	United Inch	\$21.78
RFDH1	U.I. Price	50" UI and Above	United Inch	\$0.4444

Part #	Description	Color	Length	UOM	QTY	List Price
AR105-16-12XXX	Screen Frame	Standard	12.5'	Box	152/pcs	\$1,583.72
AR109-16-11XXX	Crossbar	Standard	11.5'	Box	153/pcs	\$1,593.72
XCR205X80-XXX**	Plain Corner	Standard		Box	100/pcs	\$77.68
XCR205PSX80-XXX**	Corner Pull w/Stop	Standard		Box	100/pcs	\$83.76
XSG3769**	Leaf Spring	Mill		Box	100/pcs	\$88.96
MSFG36X100-L00	36" x 100' Char Fiber Mesh	Charcoal	100'	Roll	400 ft ²	\$184.80
SPFRD130-BX-L	Foam Spline	Black	8,000'	Box	8,000'	\$369.60

**Available in bulk quantities

RFDH2 - Roll-Formed Double Hung Half Screen

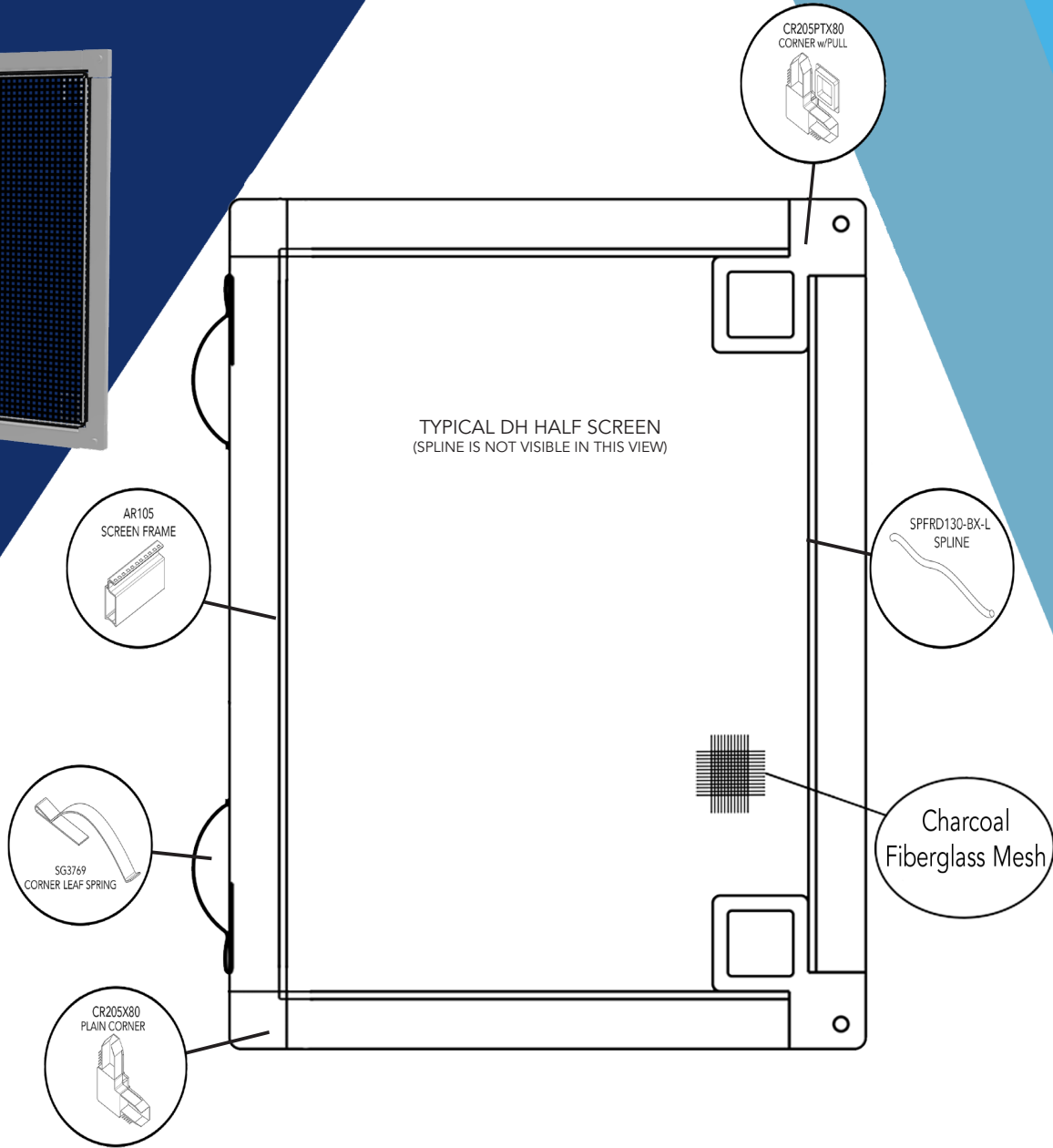
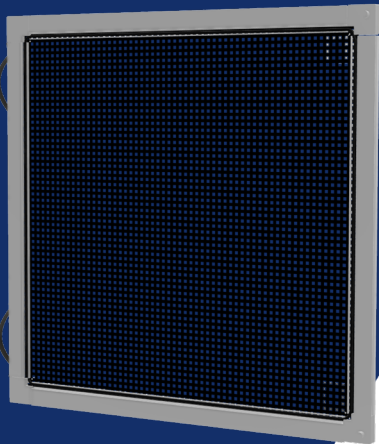

Shown in $\frac{5}{16}$ ". Also available in $\frac{3}{8}$ " and $\frac{7}{16}$ ", contact RiteScreen for details.

Standard Colors:

XXX in part numbers are
placeholders for Color Code

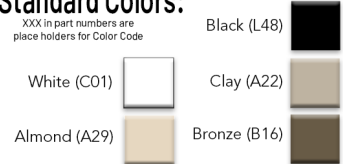

Series #	Fully Assembled Screen	Size	UOM	List Price
RFDH2	Minimum Price	0" to 49" UI	United Inch	\$22.58
RFDH2	U.I. Price	50" UI and Above	United Inch	\$0.4608

Part #	Description	Color	Length	UOM	QTY	List Price
AR105-16-12XXX	Screen Frame	Standard	12.5'	Box	152/pcs	\$1,583.72
XCR205X80-XXX**	Plain Corner	Standard		Box	100/pcs	\$77.68
XCR205PSX80-XXX**	Corner Pull w/Stop	Standard		Box	100/pcs	\$83.76
XSG3769**	Leaf Spring	Mill		Box	100/pcs	\$88.96
MSFG36X100-L00	36" x 100' Char Fiber Mesh	Charcoal	100'	Roll	400 ft ²	\$184.80
SPFRD130-BX-L	Foam Spline	Black	8,000'	Box	8,000'	\$369.60

**Available in bulk quantities

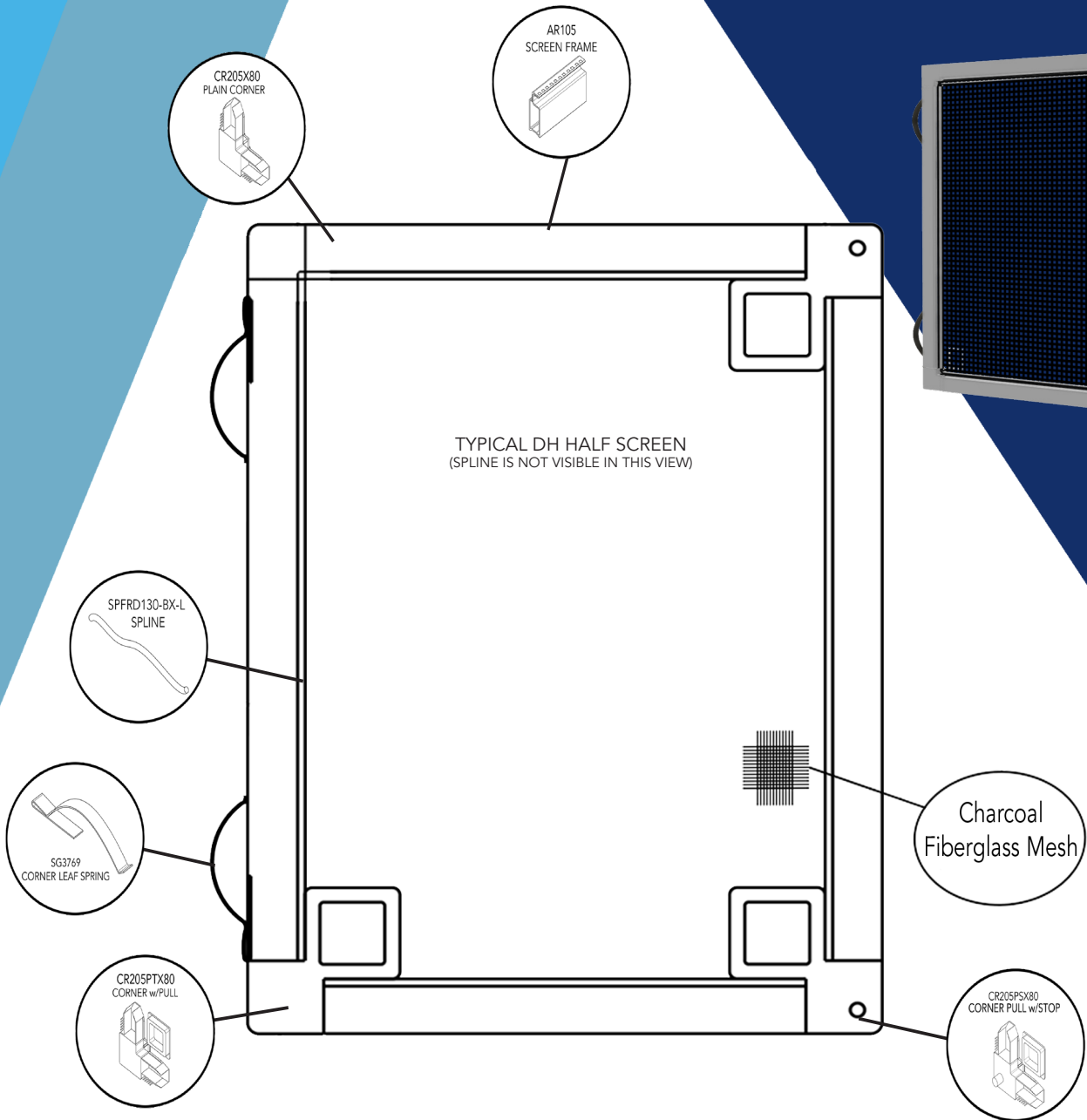

Standard Colors:

XXX in part numbers are
place holders for Color Code

Black (L48)	
White (C01)	
Almond (A29)	
Clay (A22)	
Bronze (B16)	

Shown in $\frac{5}{16}$ ". Also available in $\frac{3}{8}$ " and $\frac{7}{16}$ ", contact RiteScreen for details.

Series #	Fully Assembled Screen	Size	UOM	List Price
RFDH3	Minimum Price	0" to 49" UI	United Inch	\$22.58
RFDH3	U.I. Price	50" UI and Above	United Inch	\$0.4608

Part #	Description	Color	Length	UOM	QTY	List Price
AR105-16-12XXX	Screen Frame	Standard	12.5'	Box	152/pcs	\$1,583.72
XCR205PTX80-XXX**	Corner w/Pull	Standard		Box	100/pcs	\$83.58
XCR205X80-XXX**	Plain Corner	Standard		Box	100/pcs	\$77.68
XCR205PSX80-XXX**	Corner Pull w/Stop	Standard		Box	100/pcs	\$83.76
XSG3769**	Leaf Spring	Mill		Box	100/pcs	\$88.96
MSFG36X100-L00	36" x 100' Char Fiber Mesh	Charcoal	100'	Roll	400 ft ²	\$184.80
SPFRD130-BX-L	Foam Spline	Black	8,000'	Box	8,000'	\$369.60

**Available in bulk quantities

RFDH4 - Roll-Formed Double Hung Full Screen

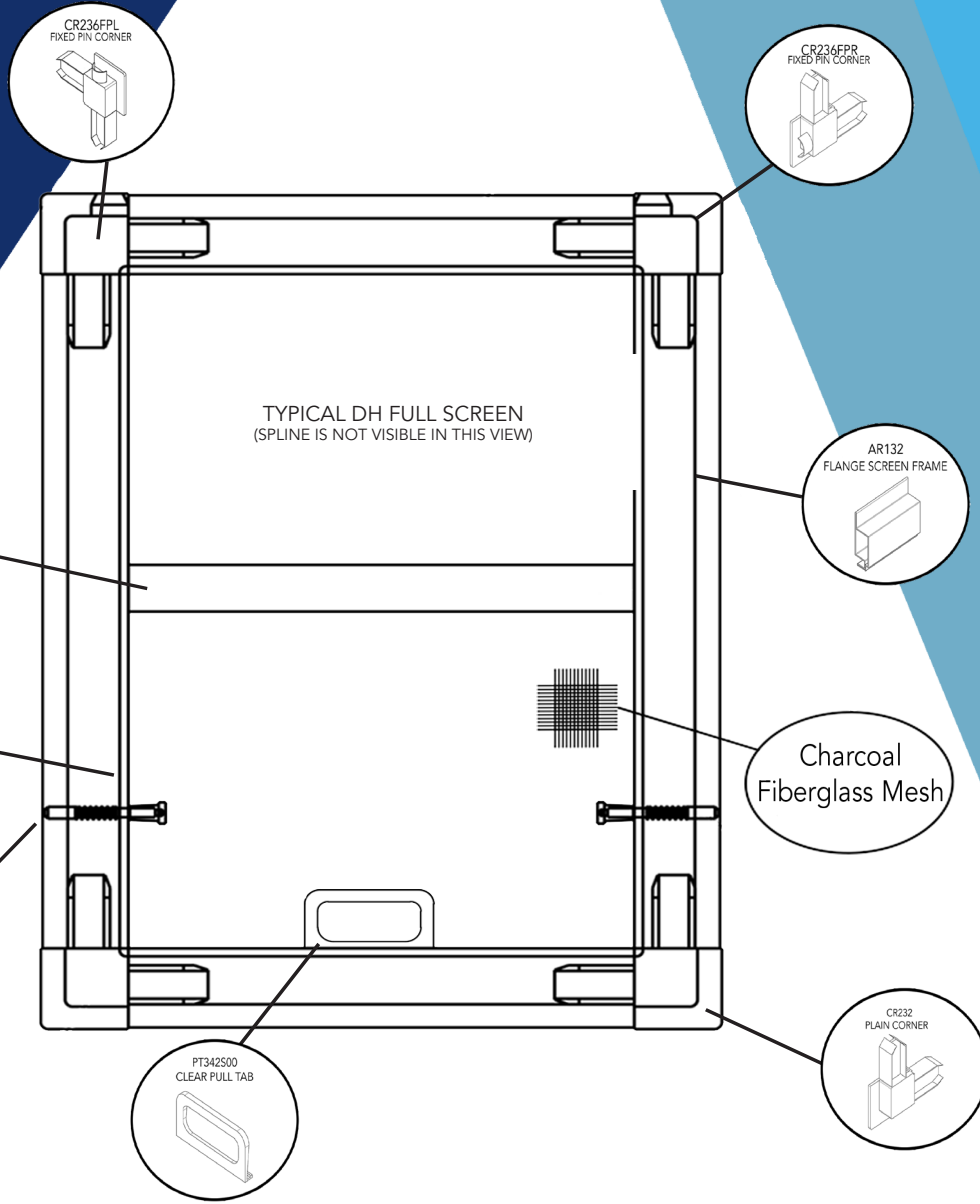
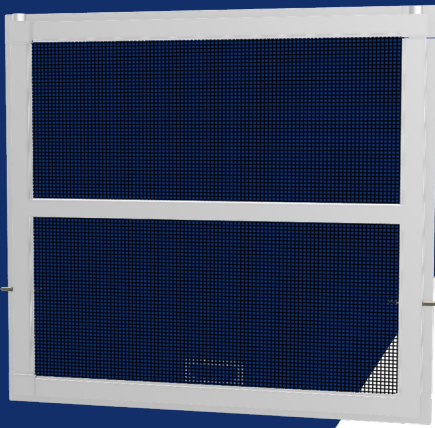

Shown in $\frac{3}{8}$ "

Standard Colors:

XXX in part numbers are place holders for Color Code



Series #	Fully Assembled Screen	Size	UOM	List Price
RFDH4	Minimum Price	0" to 49" UI	United Inch	\$25.46
RFDH4	U.I. Price	50" UI and Above	United Inch	\$0.5194

Part #	Description	Color	Length	UOM	QTY	List Price
AR132-16-12XXX	Flange Screen Frame	Standard	12.5'	Box	105/pcs	\$1,484.36
AR109-16-11XXX	Crossbar	Standard	11.5'	Box	153/pcs	\$1,593.72
XCR232-XXX**	Plain Corner	Standard		Box	100/pcs	\$125.48
XCR236FPR/L-XXX**	Fixed Pin Corner	Standard		Box	100/pcs	\$176.86
XPT342S00**	Clear Pull Tab	Clear		Box	100/pcs	\$78.74
PL315/SG412/PL308-XXX	Plunger Assembly			See Component Section for Pricing		
MSFG36X100-L00	36" x 100' Char Fiber Mesh	Charcoal	100'	Roll	400 ft ²	\$184.80
SPFRD140-BX-L	Foam Spline	Black	8,000'	Box	8,000'	\$556.80

**Available in bulk quantities

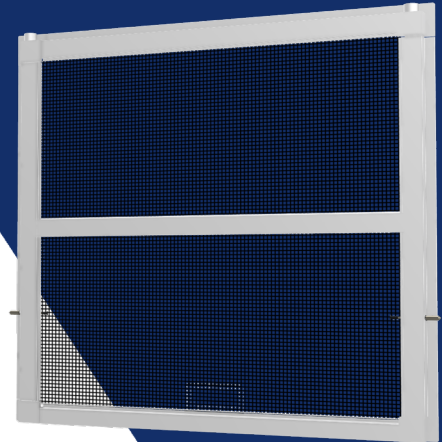
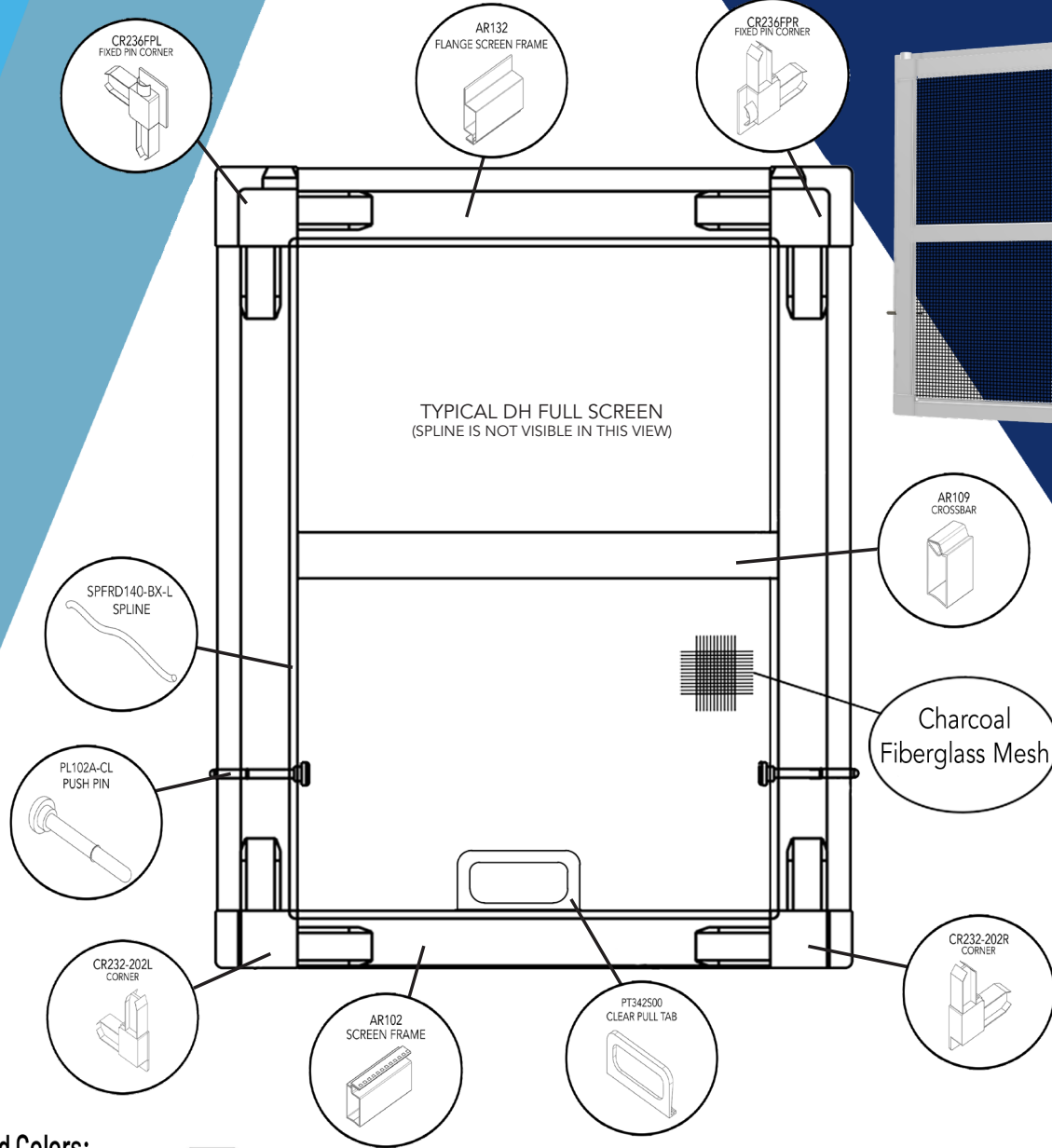

Standard Colors:

XXX in part numbers are place holders for Color Code

Black (L48)	
White (C01)	
Almond (A29)	
Clay (A22)	
Bronze (B16)	

Shown in $\frac{3}{8}$ "

Series #	Fully Assembled Screen	Size	UOM	List Price
RFDH5	Minimum Price	0" to 49" UI	United Inch	\$24.98
RFDH5	U.I. Price	50" UI and Above	United Inch	\$0.5098

Part #	Description	Color	Length	UOM	QTY	List Price
AR132-16-12XXX	Flange Screen Frame	Standard	12.5'	Box	105/pcs	\$1,484.36
AR102-16-12XXX	Screen Frame	Standard	12.5'	Box	128/pcs	\$1,419.08
AR109-16-11XXX	Crossbar	Standard	11.5'	Box	153/pcs	\$1,593.72
XCR232-202R/L-XXX**	Corner	Standard		Bag	100/pcs	\$179.16
XCR236FPR/L-XX**	Fixed Pin Corner	Standard		Box	100/pcs	\$176.86
XPT342S00**	Clear Pull Tab	Clear		Box	100/pcs	\$78.74
PL315/SG412/PL308-XXX	Plunger Assembly	See Component Section for Pricing				
MSFG36X100-L00	36" x 100' Char Fiber Mesh	Charcoal	100'	Roll	400 ft ²	\$184.80
SPFRD140-BX-L	Foam Spline	Black	8,000'	Box	8,000'	\$556.80

**Available in bulk quantities

RFDH6 - Roll-Formed Double Hung Full Screen

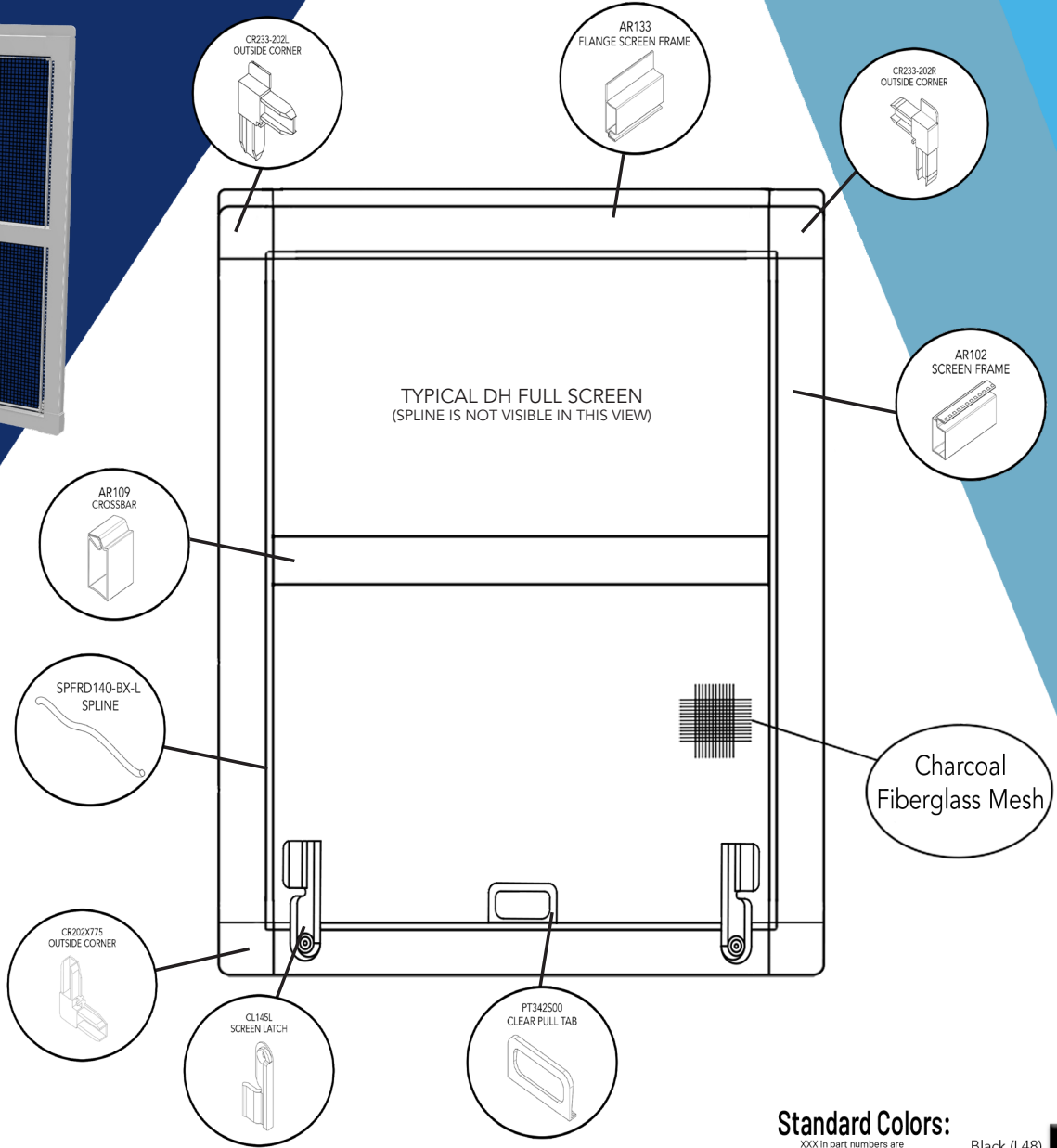
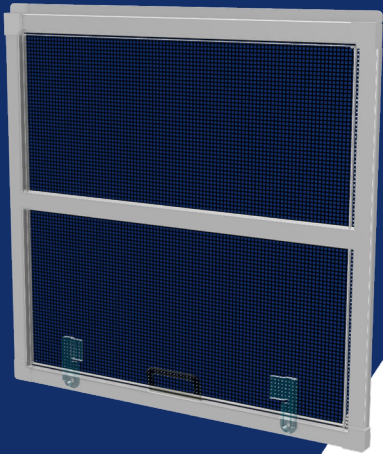

Shown in $\frac{3}{8}$ "

Standard Colors:

XXX in part numbers are place holders for Color Code

White (C01)

Almond (A29)

Black (L48)

Clay (A22)

Bronze (B16)

Series #	Fully Assembled Screen	Size	UOM	List Price
RFDH6	Minimum Price	0" to 49" UI	United Inch	\$23.60
RFDH6	U.I. Price	50" UI and Above	United Inch	\$0.4818

Part #	Description	Color	Length	UOM	QTY	List Price
AR133-16-12XXX	Flange Screen Frame	Standard	12.5'	Box	105/pcs	\$1,525.52
AR102-16-12XXX	Screen Frame	Standard	12.5'	Box	128/pcs	\$1,419.08
AR109-16-11XXX	Crossbar	Standard	11.5'	Box	153/pcs	\$1,593.72
XCR233-202L/R**	Plain Corner	Standard		Box	100/pcs	\$134.18
XCR202X775-XXX**	Outside Corner	Standard		Box	100/pcs	\$211.80
XCL145L/R-S00**	Screen Latch	Clear		Box	100/pcs	\$95.38
XPT342S00**	Clear Pull Tab	Clear		Box	100/pcs	\$78.74
MSFG36X100-L00	36" x 100' Char Fiber Mesh	Charcoal	100'	Roll	400 ft ²	\$184.80
SPFRD140-BX-L	Foam Spline	Black	8,000'	Box	8,000'	\$556.80

**Available in bulk quantities

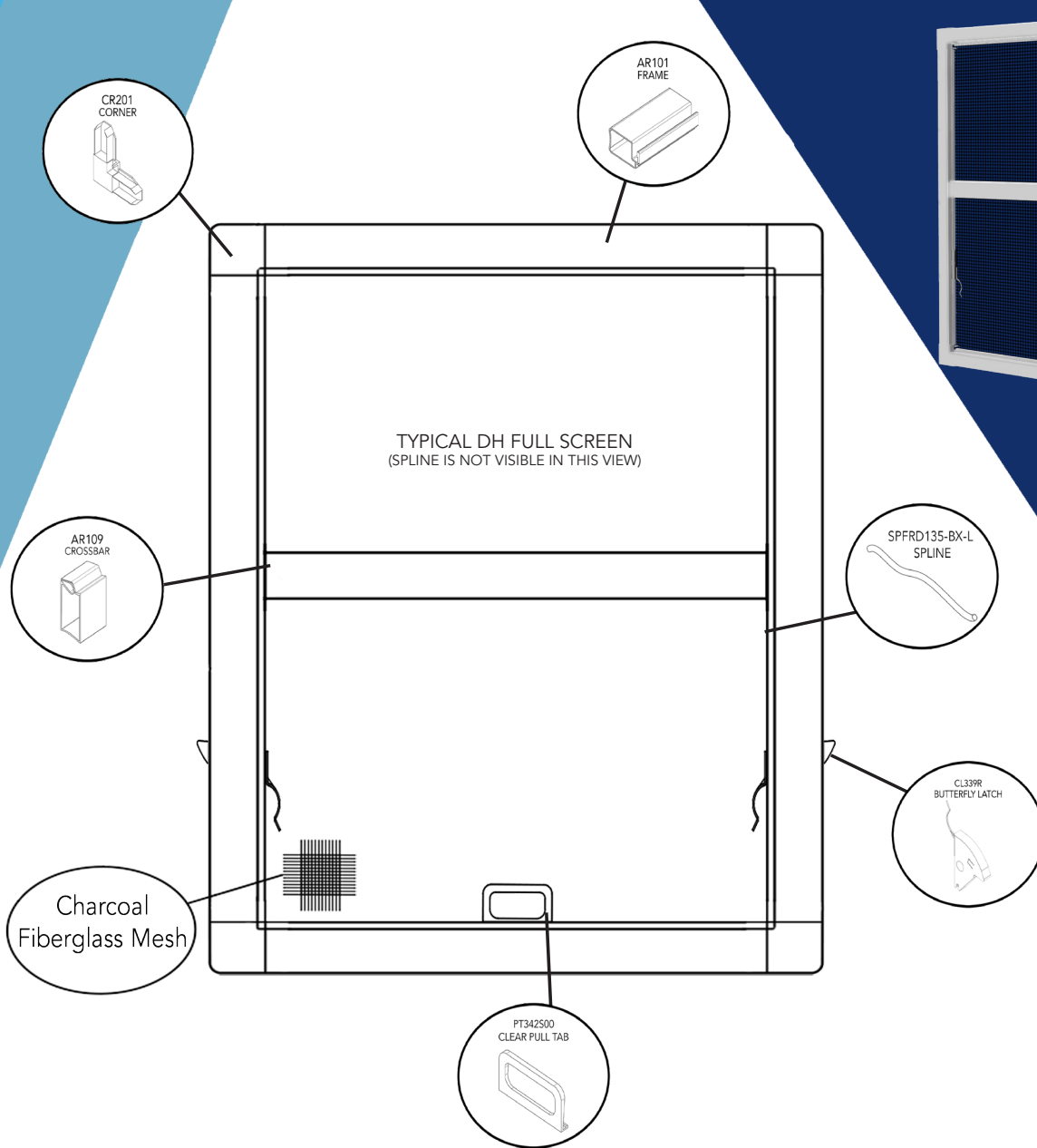

Standard Colors:

XXX in part numbers are place holders for Color Code

Black (L48)	
White (C01)	
Almond (A29)	
Clay (A22)	
Bronze (B16)	

Shown in $\frac{3}{8}$ "

Series #	Fully Assembled Screen	Size	UOM	List Price
RFDH7	Minimum Price	0" to 49" UI	United Inch	\$24.82
RFDH7	U.I. Price	50" UI and Above	United Inch	\$0.5064

Part #	Description	Color	Length	UOM	QTY	List Price
AR101-16-12XXX	Screen Frame	Standard	12.5'	Box	112/pcs	\$1,293.64
AR109-16-11XXX	Crossbar	Standard	11.5'	Box	153/pcs	\$1,593.72
XCR201-XXX**	Outside Corner	Standard		Box	100/pcs	\$119.48
XCL339R/L**	Butterfly Latch	Mill		Box	100/pcs	\$76.10
XPT342S00**	Clear Pull Tab	Clear		Box	100/pcs	\$78.74
MSFG36X100-L00	36" x 100' Char Fiber Mesh	Charcoal	100'	Roll	400 ft ²	\$184.80
SPFRD135-BX-L	.135" Diameter Foam Spline	Black	8,000'	Box	8,000'	\$564.48

**Available in bulk quantities

RFSL1 - Roll-Formed Slider Screen

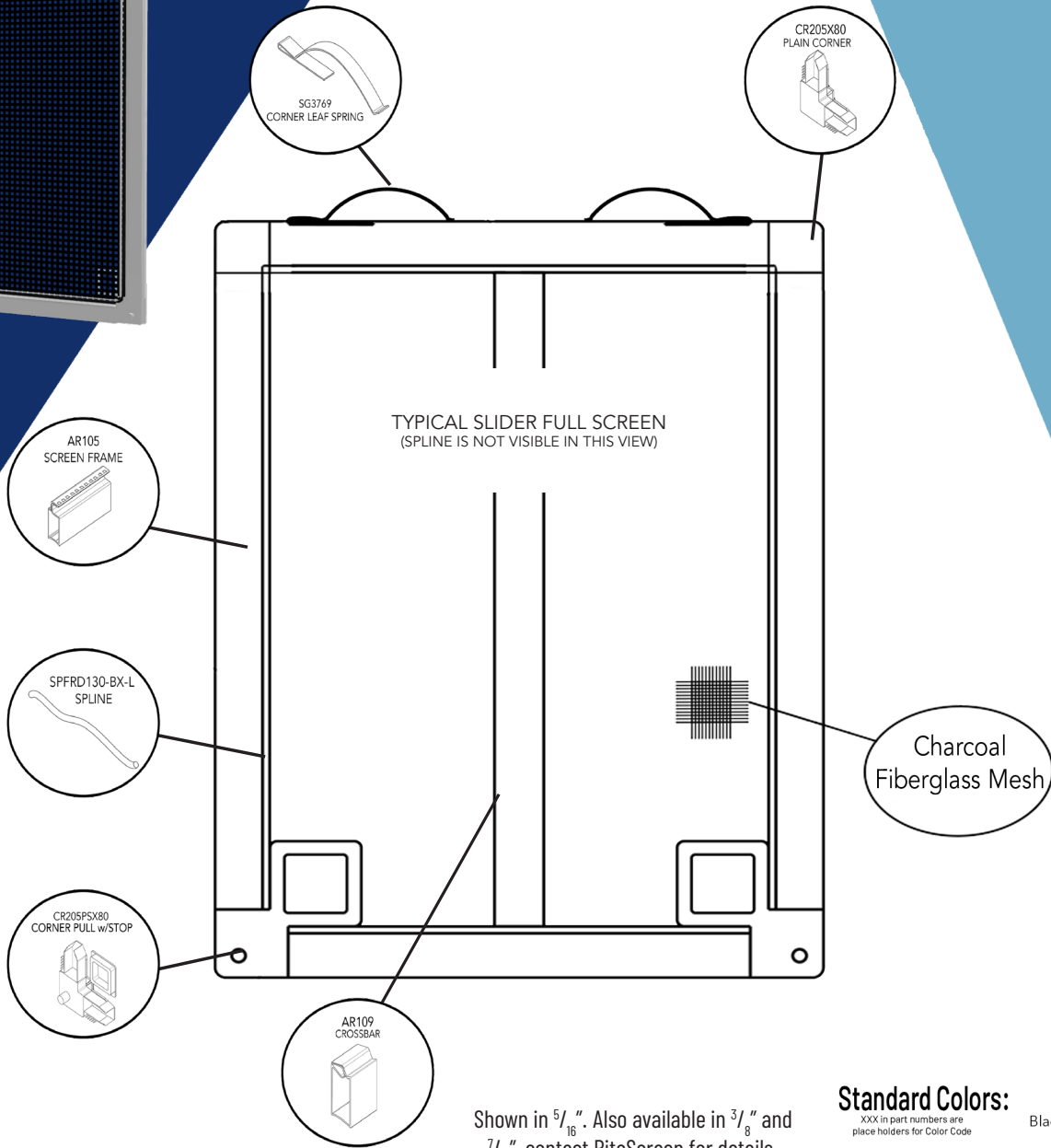
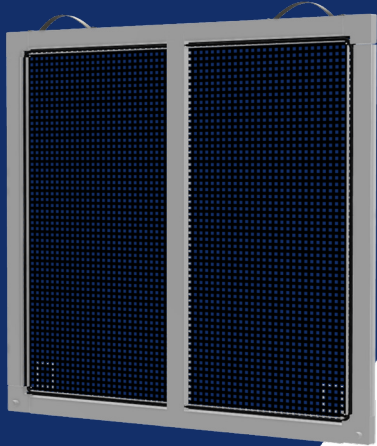

Shown in $\frac{5}{16}$ ". Also available in $\frac{3}{8}$ " and $\frac{7}{16}$ " contact RiteScreen for details.

Standard Colors:

XXX in part numbers are place holders for Color Code

White (C01)

Almond (A29)

Black (L48)

Clay (A22)

Bronze (B16)

Series #	Fully Assembled Screen	Size	UOM	List Price
RFSL1	Minimum Price	0" to 49" UI	United Inch	\$22.66
RFSL1	U.I. Price	50" UI and Above	United Inch	\$0.4626

Part #	Description	Color	Length	UOM	QTY	List Price
AR105-16-12XXX	Screen Frame	Standard	12.5'	Box	152/pcs	\$1,583.72
AR109-16-11XXX	Crossbar	Standard	11.5'	Box	153/pcs	\$1,593.72
XCR205X80-XXX**	Plain Corner	Standard		Box	100/pcs	\$77.68
XCR205PSX80-XXX**	Corner Pull w/Stop	Standard		Box	100/pcs	\$83.76
XSG3769**	Leaf Spring	Mill		Box	100/pcs	\$88.96
MSFG36X100-L00	36" x 100' Char Fiber Mesh	Charcoal	100'	Roll	400 ft ²	\$184.80
SPFRD130-BX-L	Foam Spline	Black	8,000'	Box	8,000'	\$369.60

**Available in bulk quantities

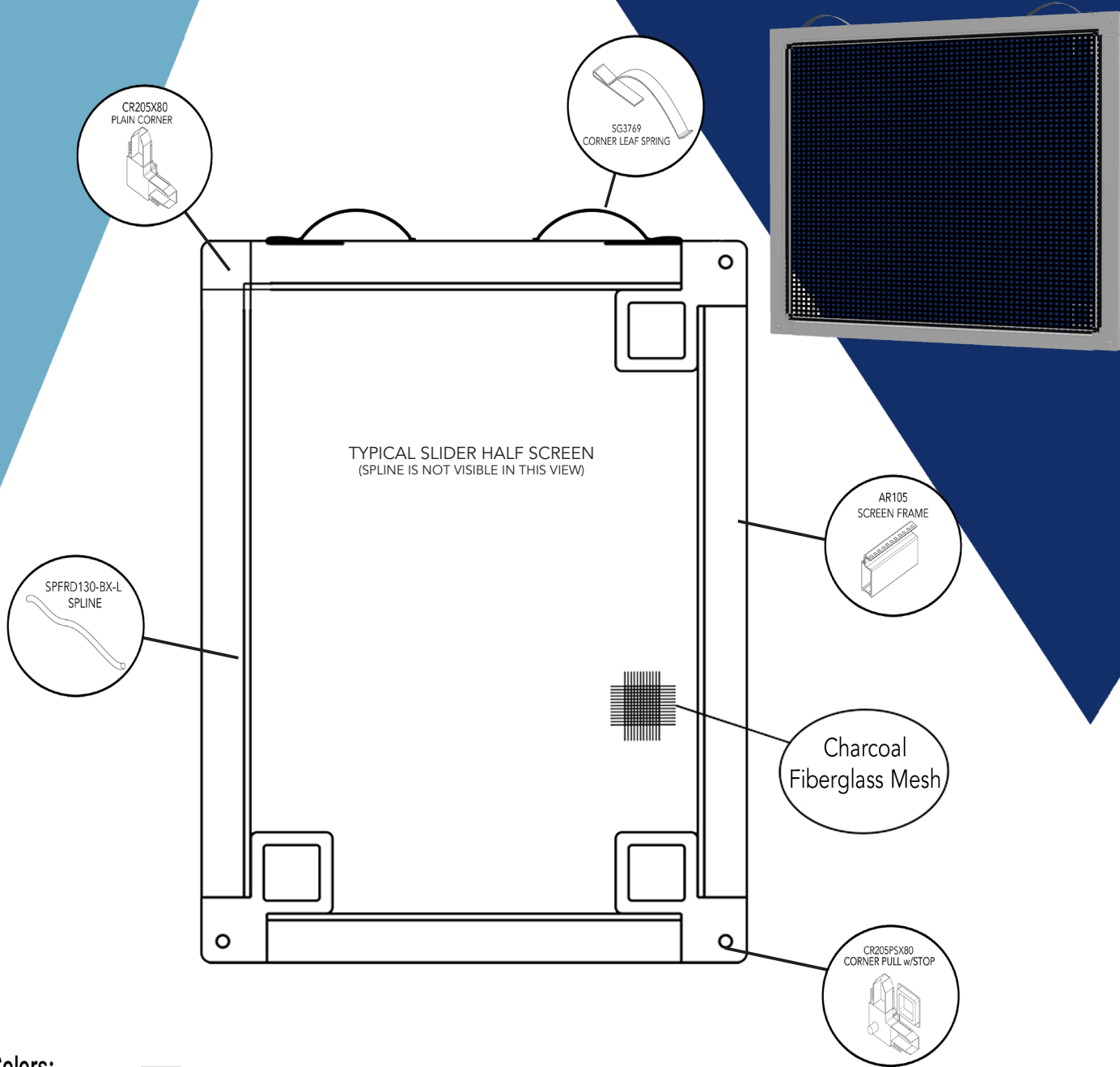

Standard Colors:

XXX in part numbers are place holders for Color Code

Black (L48)	
White (C01)	
Clay (A22)	
Almond (A29)	
Bronze (B16)	

Shown in $\frac{5}{16}$ ". Also available in $\frac{3}{8}$ " and $\frac{7}{16}$ ", contact RiteScreen for details.

Series #	Fully Assembled Screen	Size	UOM	List Price
RFSL2	Minimum Price	0" to 49" UI	United Inch	\$21.44
RFSL2	U.I. Price	50" UI and Above	United Inch	\$0.4376

Part #	Description	Color	Length	UOM	QTY	List Price
AR105-16-12XXX	Screen Frame	Standard	12.5'	Box	152/pcs	\$1,583.72
XCR205X80-XXX**	Plain Corner	Standard		Box	100/pcs	\$77.68
XCR205PSX80-XXX**	Corner Pull w/Stop	Standard		Box	100/pcs	\$83.76
XSG3769**	Leaf Spring	Mill		Box	100/pcs	\$88.96
MSFG36X100-L00	36" x 100' Char Fiber Mesh	Charcoal	100'	Roll	400 ft ²	\$184.80
SPFRD130-BX-L	Foam Spline	Black	8,000'	Box	8,000'	\$369.60

**Available in bulk quantities

RFSL3 - Roll-Formed Slider Screen

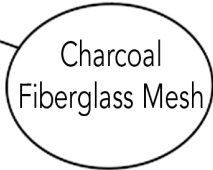
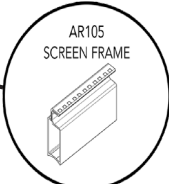
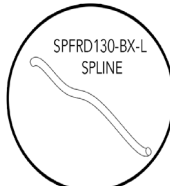
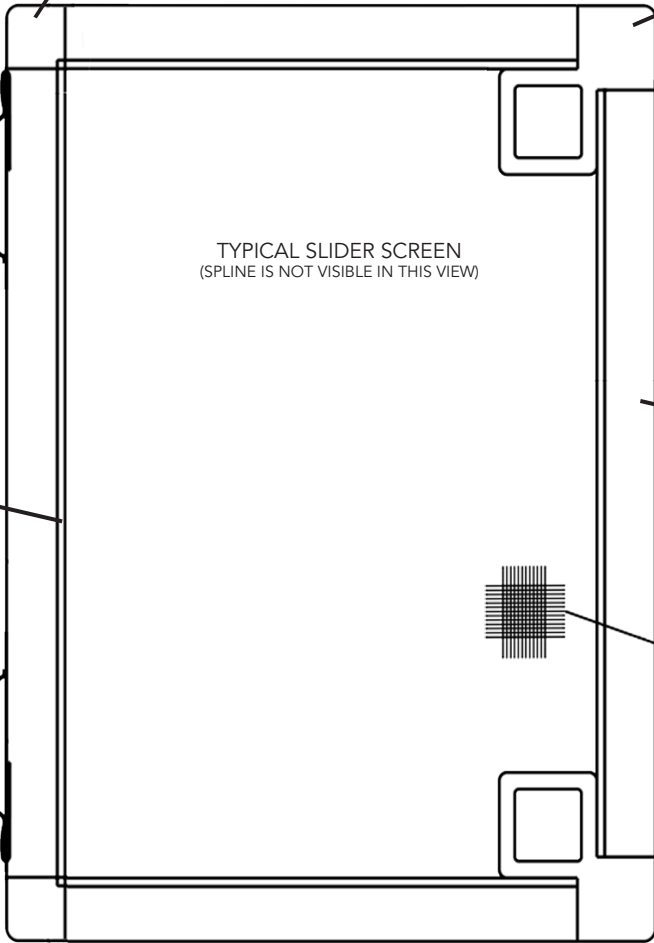
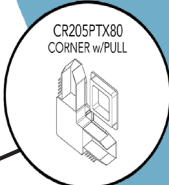
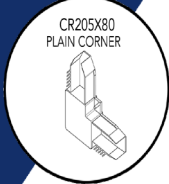
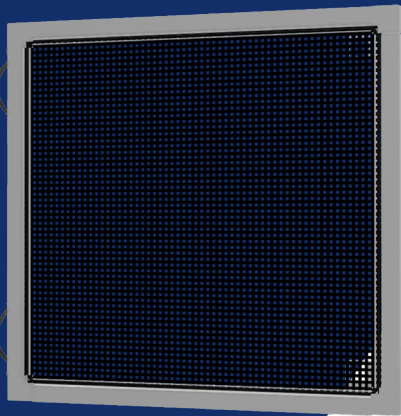

Shown in $\frac{5}{16}$ ". Also available in $\frac{3}{8}$ " and $\frac{7}{16}$ ", contact RiteScreen for details.

Standard Colors:

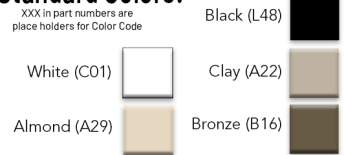

Series #	Fully Assembled Screen	Size	UOM	List Price
RFSL3	Minimum Price	0" to 49" UI	United Inch	\$22.58
RFSL3	U.I. Price	50" UI and Above	United Inch	\$0.4608
RFSL3-W	With Woolpile	50" UI and Above	United Inch	\$0.5174

Part #	Description	Color	Length	UOM	QTY	List Price
AR105-16-12XXX	Screen Frame	Standard	12.5'	Box	152/pcs	\$1,583.72
XCR205X80-XXX**	Plain Corner	Standard		Box	100/pcs	\$77.68
XCR205PTX80-XXX**	Corner w/Pull	Standard		Box	100/pcs	\$83.58
XSG3769**	Leaf Spring	Mill		Box	100/pcs	\$88.96
MSFG36X100-L00	36" x 100' Char Fiber Mesh	Charcoal	100'	Roll	400 ft ²	\$184.80
SPFRD130-BX-L	Foam Spline	Black	8,000'	Box	8,000'	\$369.60

**Available in bulk quantities

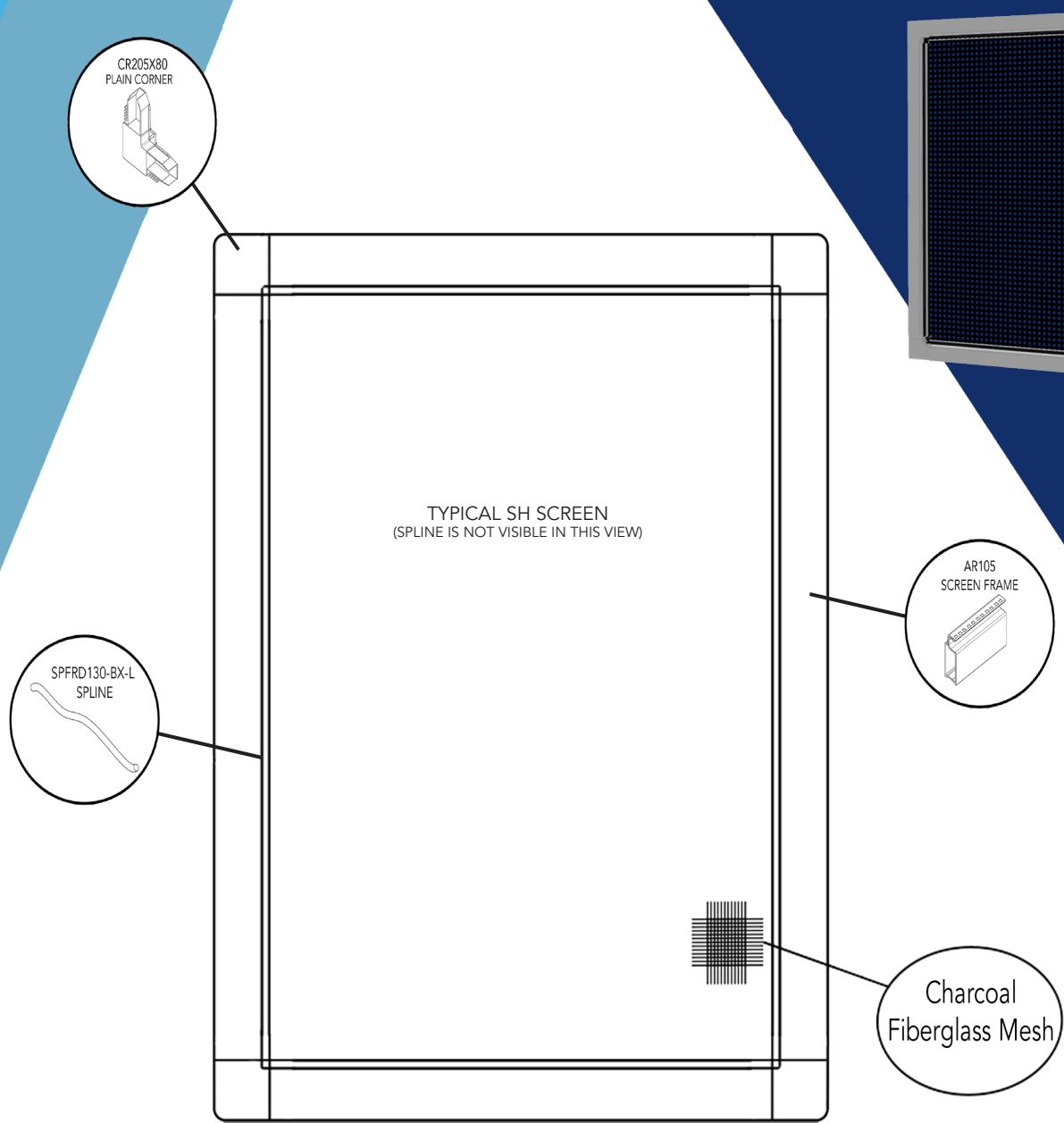

Standard Colors:

XXX in part numbers are
place holders for Color Code

Black (L48)	
White (C01)	
Almond (A29)	
Clay (A22)	
Bronze (B16)	

Shown in $\frac{5}{16}$ ". Also available in $\frac{3}{8}$ " and $\frac{7}{16}$ ", contact RiteScreen for details.

Series #	Fully Assembled Screen	Size	UOM	List Price
RFFS1	Minimum Price	0" to 49" UI	United Inch	\$22.16
RFFS1	U.I. Price	50" UI and Above	United Inch	\$0.4520

Part #	Description	Color	Length	UOM	QTY	List Price
AR105-16-12XXX	Screen Frame	Standard	12.5'	Box	152/pcs	\$1,583.72
XCR205X80-XXX**	Plain Corner	Standard		Box	100/pcs	\$77.68
MSFG36X100-L00	36" x 100' Char Fiber Mesh	Charcoal	100'	Roll	400 ft ²	\$184.80
SPFRD130-BX-L	Foam Spline	Black	8,000'	Box	8,000'	\$369.60

**Available in bulk quantities

RFFS2 - Roll-Formed Full Screen

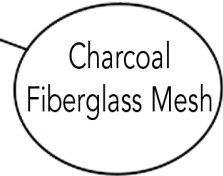
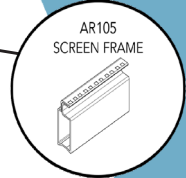
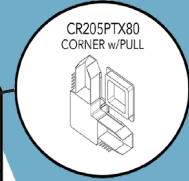
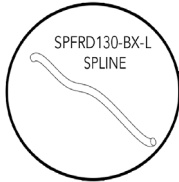
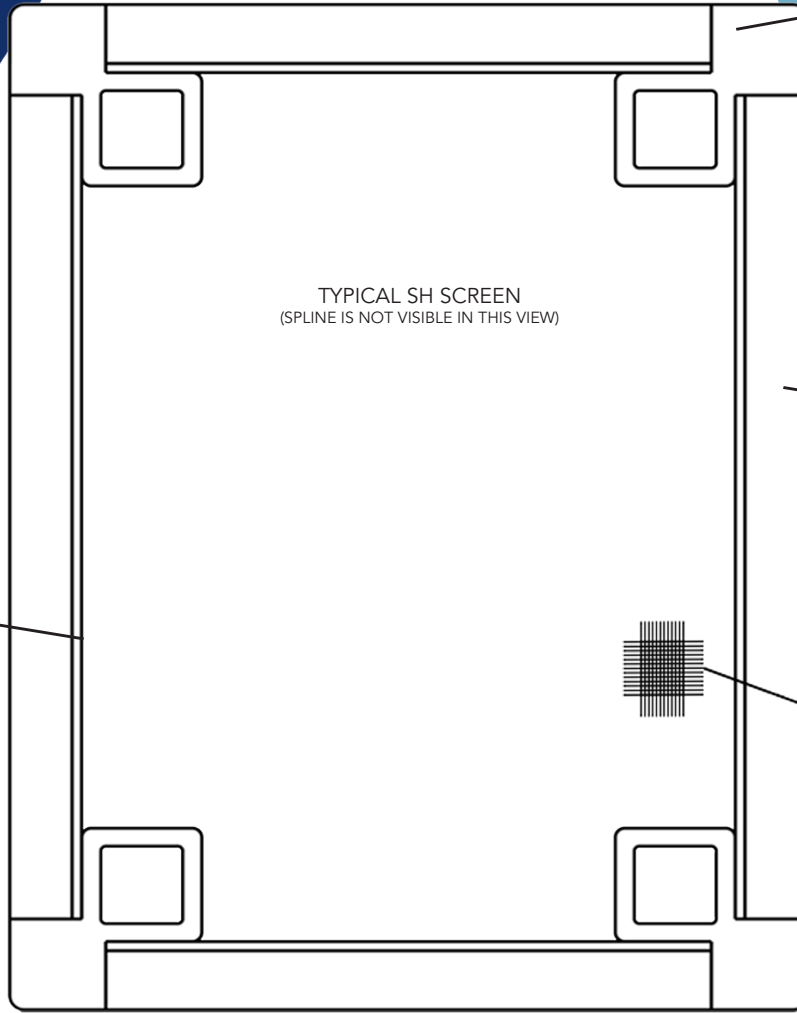
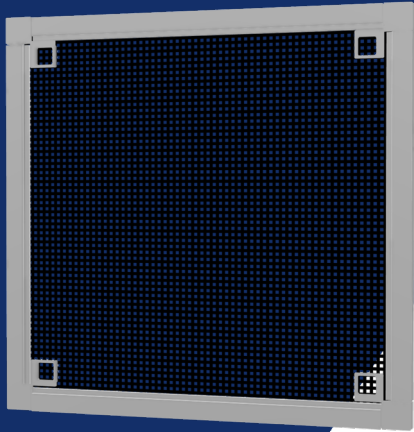

Shown in $\frac{5}{16}$ ". Also available in $\frac{3}{8}$ " and $\frac{7}{16}$ ", contact RiteScreen for details.

Standard Colors:

XXX in part numbers are
place holders for Color Code

White (C01)

Almond (A29)

Black (L48)

Clay (A22)

Bronze (B16)

Series #	Fully Assembled Screen	Size	UOM	List Price
RFFS2	Minimum Price	0" to 49" UI	United Inch	\$22.16
RFFS2	U.I. Price	50" UI and Above	United Inch	\$0.4520

Part #	Description	Color	Length	UOM	QTY	List Price
AR105-16-12XXX	Screen Frame	Standard	12.5'	Box	152/pcs	\$1,583.72
XCR205PTX80-XXX**	Corner w/Pull	Standard		Box	100/pcs	\$83.58
MMSG36X100-L00	36" x 100' Char Fiber Mesh	Charcoal	100'	Roll	400 ft ²	\$184.80
SPFRD130-BX-L	Foam Spline	Black	8,000'	Box	8,000'	\$369.60

**Available in bulk quantities

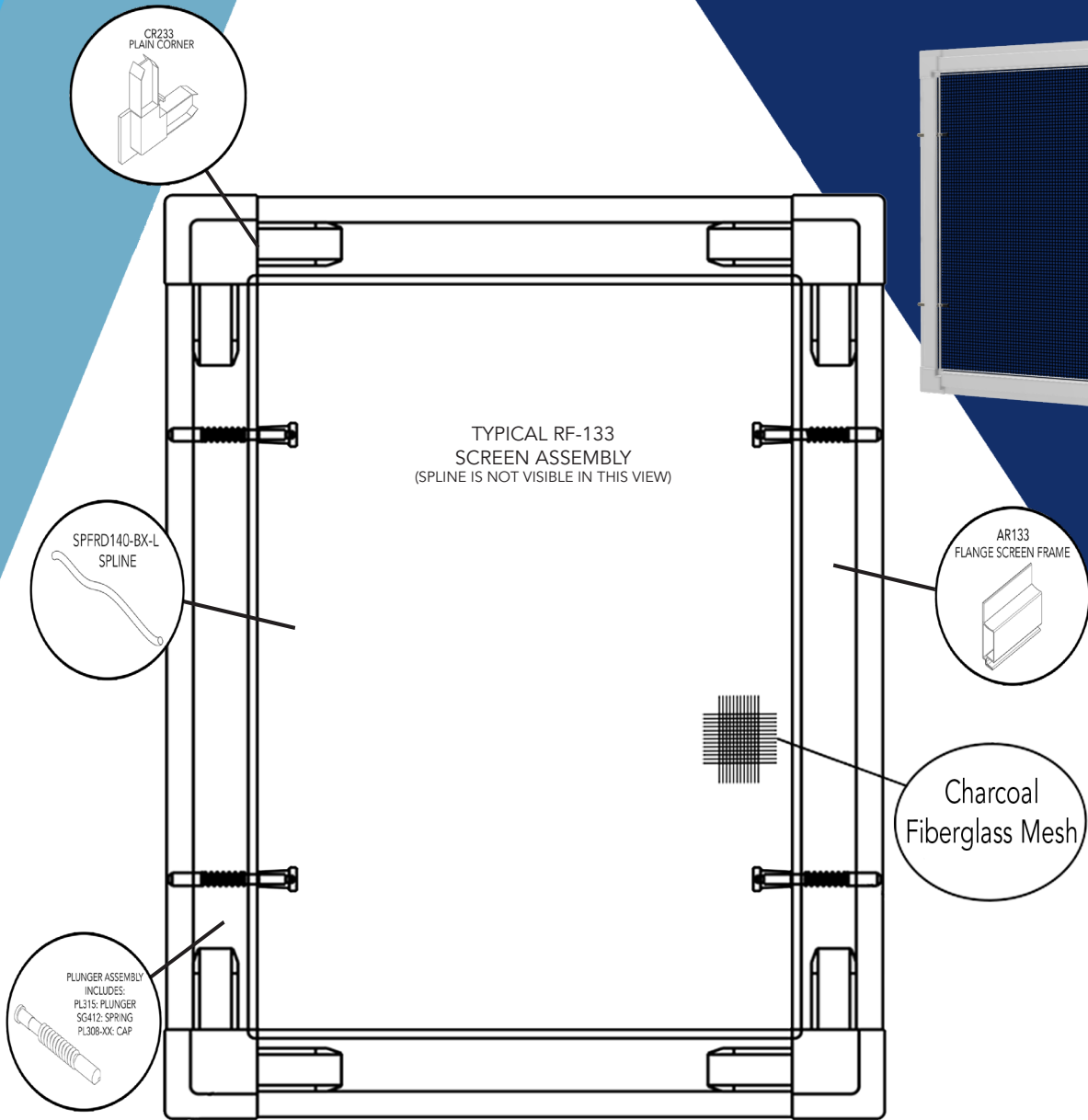

Standard Colors:

XXX in part numbers are place holders for Color Code

White (C01)

Almond (A29)

Black (L48)

Clay (A22)

Bronze (B16)

Shown in $\frac{3}{8}$ "

Series #	Fully Assembled Screen	Size	UOM	List Price
RFCA1	Minimum Price	0" to 49" UI	United Inch	\$25.96
RFCA1	U.I. Price	50" UI and Above	United Inch	\$0.5296

Part #	Description	Color	Length	UOM	QTY	List Price
AR133-16-12XXX	Flange Screen Frame	Standard	12.5'	Box	105/pcs	\$1,525.52
XCR233-XXX**	Plain Corner	Standard		Box	100/pcs	\$151.60
PL315/SG412/PL308-XXX	Plunger Assembly	See Component Section for Pricing				
SPFRD140-BX-L	Foam Spline	Black	8,000'	Box	8,000'	\$556.80
MSFG36X100-L00	36" x 100' Char Fiber Mesh	Charcoal	100'	Roll	400 ft ²	\$184.80

**Available in bulk quantities

RFCA2 - Roll-Formed Casement Screen

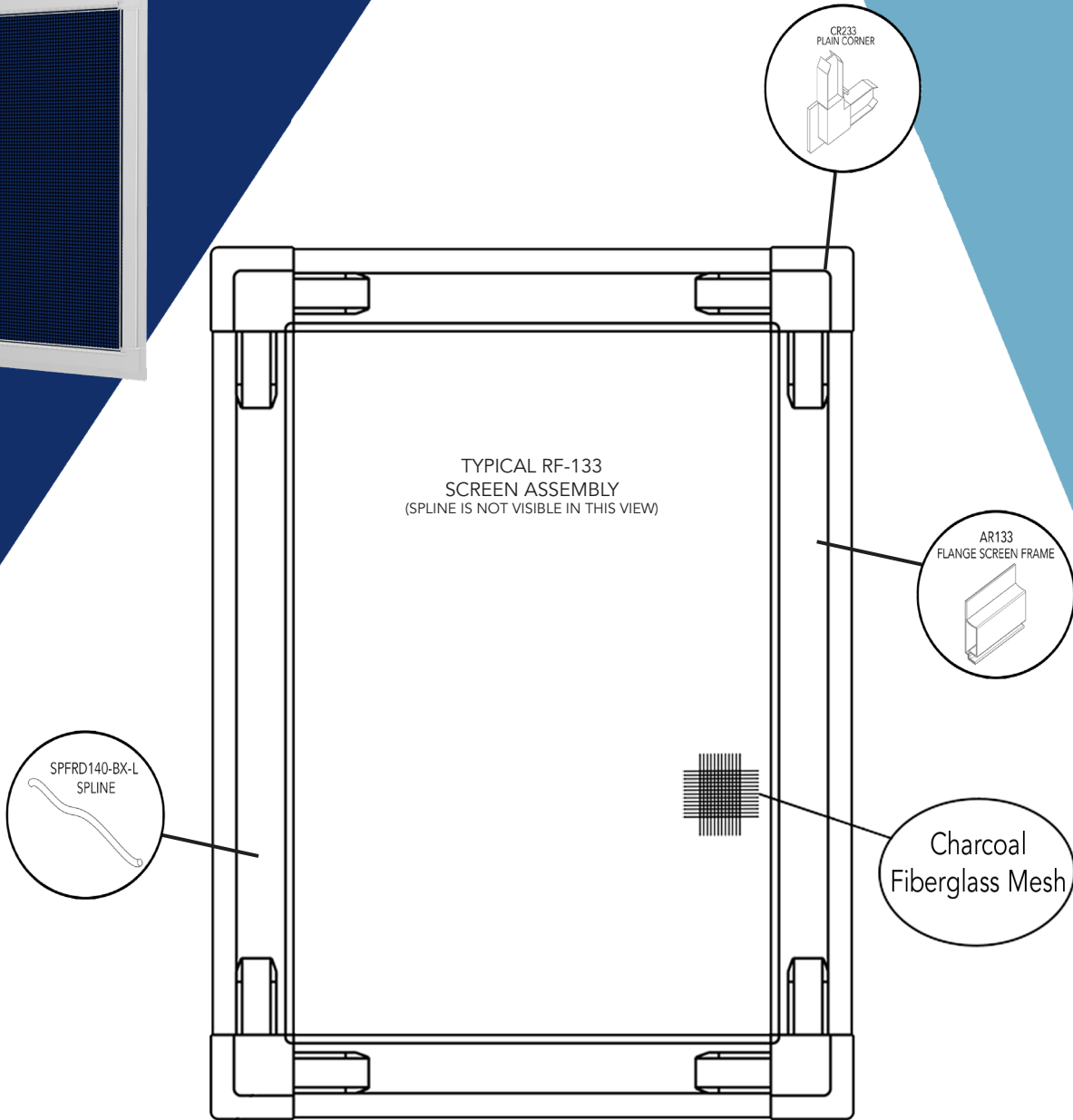
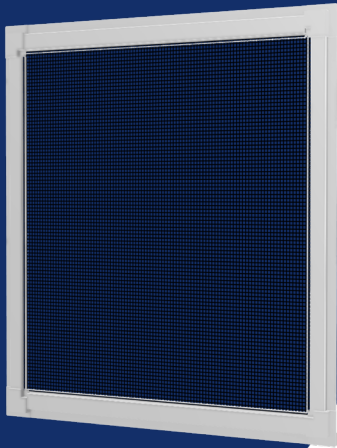

Shown in $\frac{3}{8}$ "

Standard Colors:

XXX in part numbers are place holders for Color Code

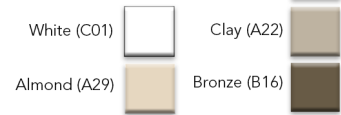

Series #	Fully Assembled Screen	Size	UOM	List Price
RFCA2	Minimum Price	0" to 49" UI	United Inch	\$24.30
RFCA2	U.I. Price	50" UI and Above	United Inch	\$0.4962

Part #	Description	Color	Length	UOM	QTY	List Price
AR133-16-12XXX	Flange Screen Frame	Standard	12.5'	Box	105/pcs	\$1,525.52
XCR233-XXX**	Plain Corner	Standard		Box	100/pcs	\$151.60
SPFRD140-BX-L	Foam Spline	Black	8,000'	Box	8,000'	\$556.80
MSFG36X100-L00	36" x 100' Char Fiber Mesh	Charcoal	100'	Roll	400 ft ²	\$184.80

**Available in bulk quantities

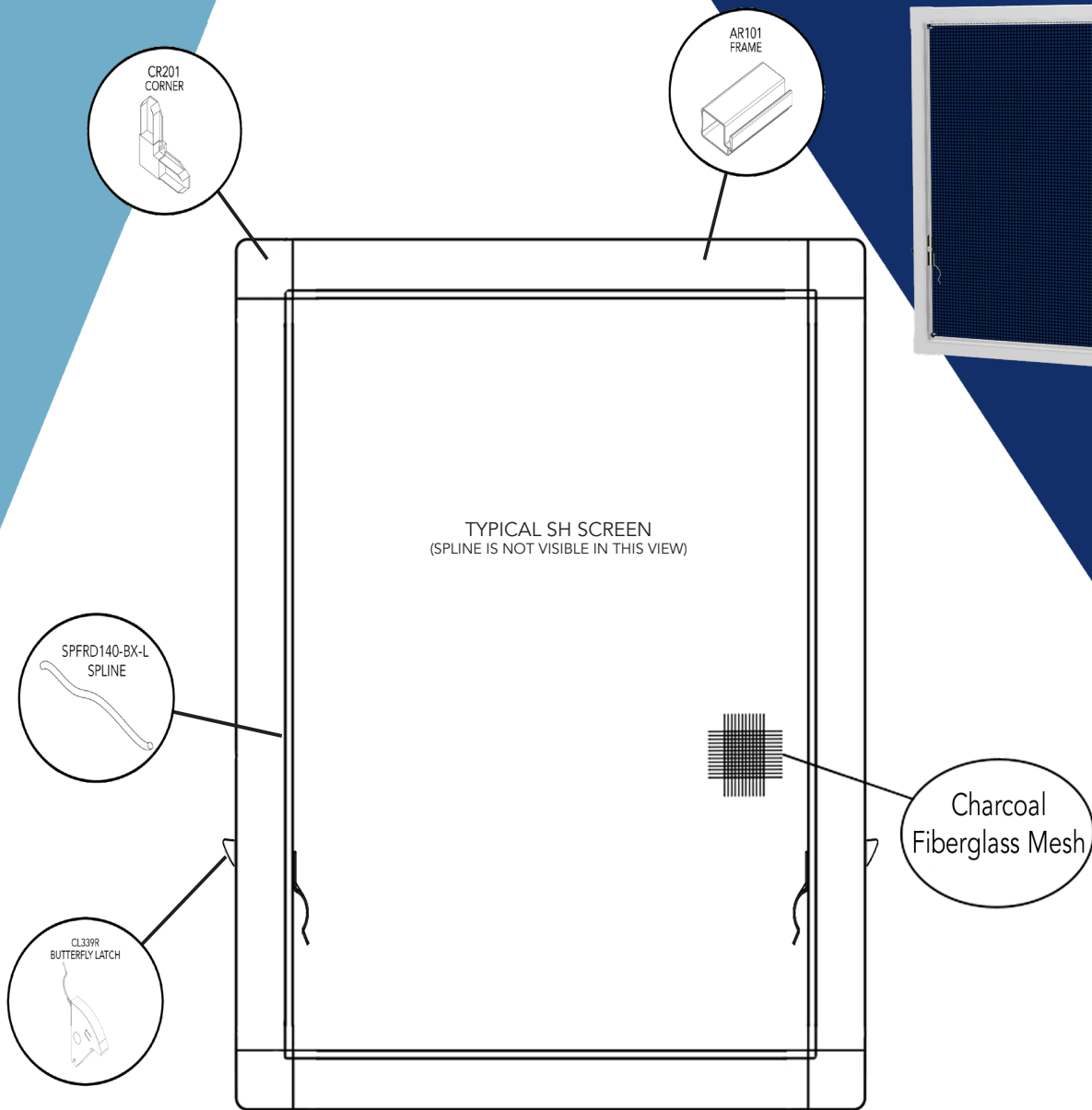

Standard Colors:

XXX in part numbers are
placeholders for Color Code



Shown in $7\frac{1}{16}$ "

Series #	Fully Assembled Screen	Size	UOM	List Price
RFCA3	Minimum Price	0" to 49" UI	United Inch	\$26.84
RFCA3	U.I. Price	50" UI and Above	United Inch	\$0.5480

Part #	Description	Color	Length	UOM	QTY	List Price
AR101-16-12XXX	Screen Frame	Standard	12.5'	Box	112/pcs	\$1,293.64
XCR201-XXX**	Outside Corner	Standard		Box	100/pcs	\$119.48
XCL339R/L**	Butterfly Latch	Mill		Box	100/pcs	\$76.10
SPFRD140-BX-L	Foam Spline	Black	8,000'	Box	8,000'	\$556.80
MSFG36X100-L00	36" x 100' Char Fiber Mesh	Charcoal	100'	Roll	400 ft ²	\$184.80

**Available in bulk quantities



PATIO DOOR SCREENS



Love the air you breathe...

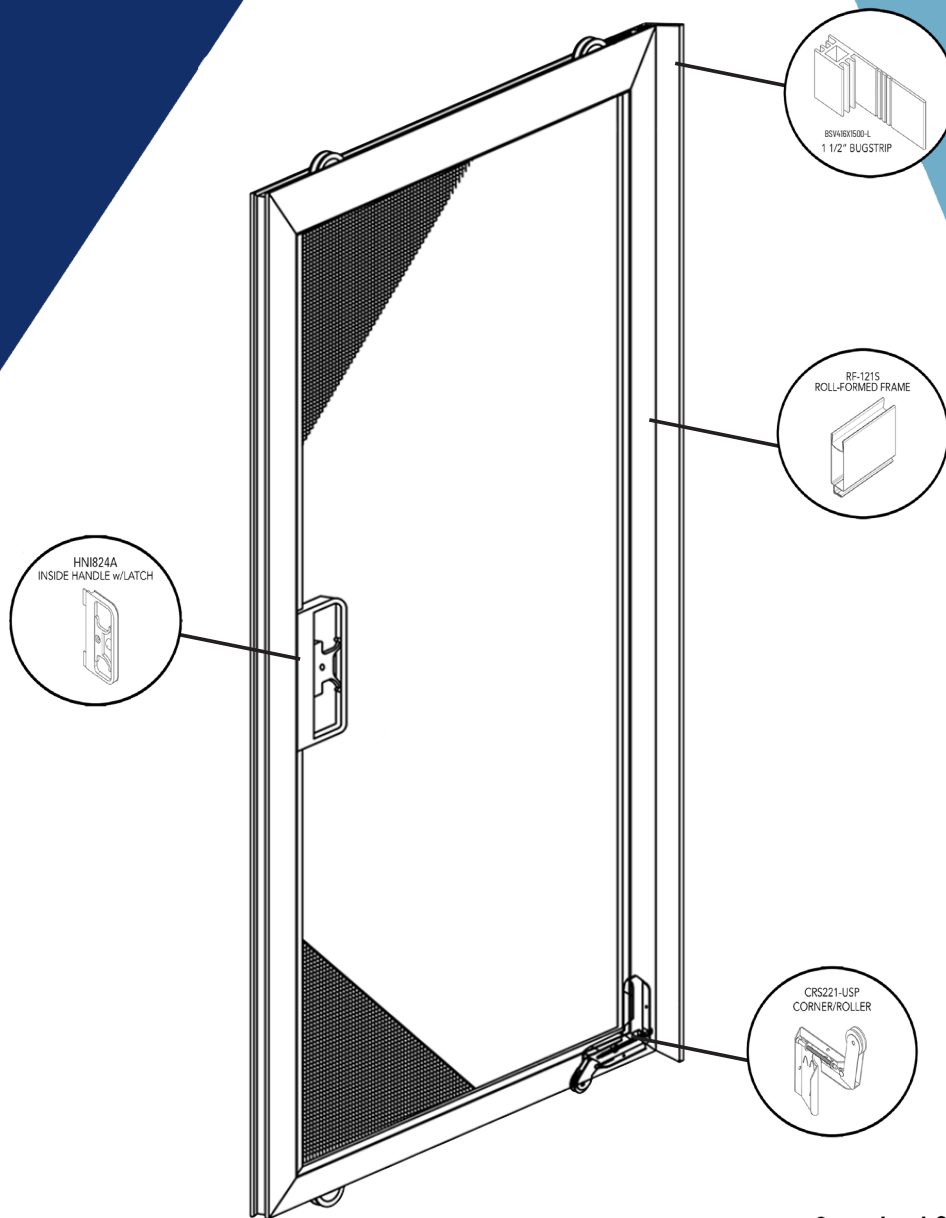

Standard Colors

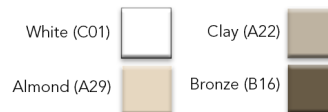

Part #	Description	QTY	List Price
RF-121S	Fully Assembled	United Inch	\$1.3672
CRS221-USS	Steel Roller	Optional	\$20.00/Unit

Part #	Description	Color	Length	UOM	QTY	List Price
SR121-19-100XXX	121 Steel Frame	Standard (No Black)	8.1'	Box	48/pcs	\$1,947.97
CR221-USP	Corner/Plastic Roller	Standard		Box	250/pcs	\$1,936.20
XHNI824A-L48**	Inside Handle w. Latch	Black		Box	100/box	\$243.22
XHNI824I-L48**	Outside Handle (Not Shown)	Black		Box	100/box	\$156.98
XHNS481-4**	Standard T Latch	Mill		Box	100/box	\$114.74
HB-1115-7	Standard Strike Bag (Not Shown)			Box	100/box	\$200.00
BSV416X1500-L	1.5" Bug Strip	Black	286'	Roll	286'	\$297.20

**Available in bulk quantities

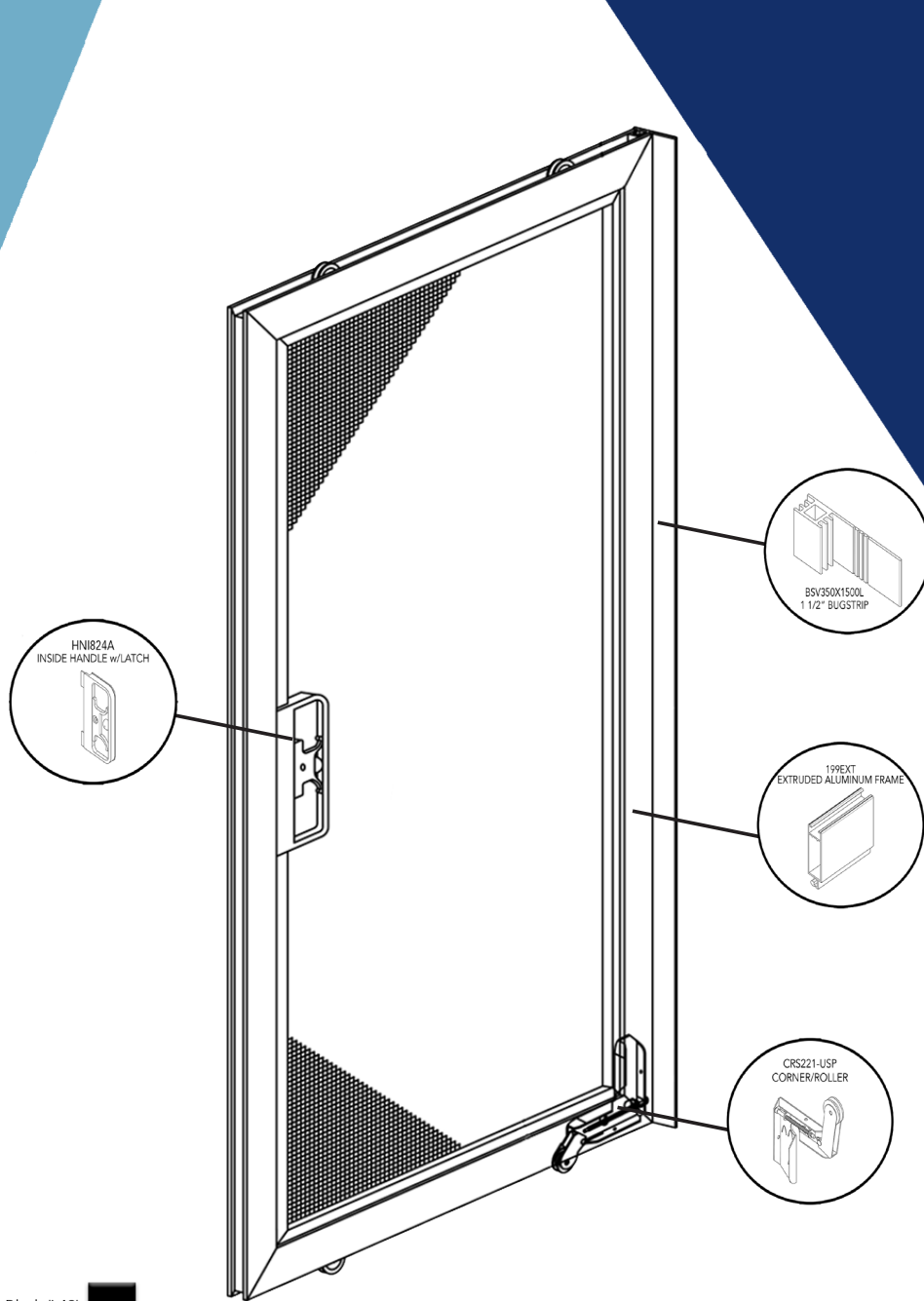

Standard Colors:

XXX in part numbers are
place holders for Color Code



Part #	Description	QTY	List Price
199EXT	Fully Assembled	United Inch	1.4786
CRS221-USS	Steel Roller	Optional	\$20.00/Unit

Part #	Description	Color	Length	UOM	QTY	List Price
EA1749-150-XXX	199EXT Extruded Aluminum Frame	Standard	12.5'	Box	10/pcs	\$775.60
CR221-USP	Corner/Plastic Roller	Standard		Box	250/pcs	\$1,936.20
XHNI824A-L48**	Inside Handle w. Latch	Black		Box	100/box	\$243.22
XHNI824I-L48**	Outside Handle (Not Shown)	Black		Box	100/box	\$156.98
XHNS481-4**	Standard T Latch	Mill		Box	100/box	\$114.74
HB-1115-3	Standard Strike Bag (Not Shown)			Box	100/box	\$200.00
BSV350X1500-L	1.5" Bug Strip	Black	286'	Roll	286'	\$133.68

**Available in bulk quantities

144EXT - Extruded Patio Door Screen

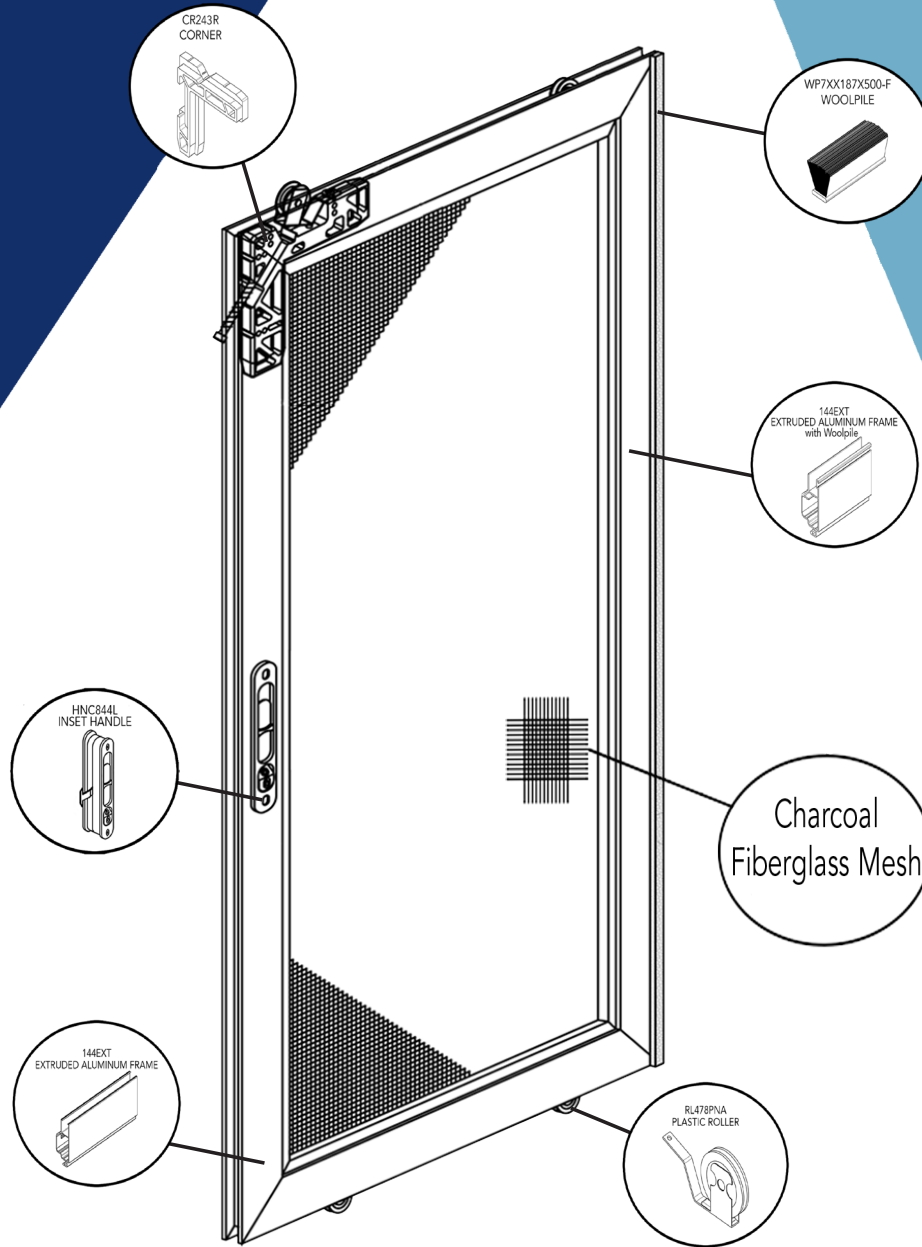

Part #	Description	QTY	List Price
144EXT	Fully Assembled	United Inch	\$1.6168
RL478S	Steel Roller	Optional	\$20.00/Unit
RL478ST	Stainless Steel Roller	Optional	\$40.00/Unit
144EXT Knock Down	Unassembled (packaging included)	1 per box	\$2.69/UI

Standard Colors:

XXX in part numbers are
place holders for Color Code

White (C01)

Almond (A29)

Black (L48)

Clay (A22)

Bronze (B16)

Part #	Description	Color	Length	UOM	QTY	List Price
EA16282-150-XXX	144EXT Extruded Aluminum Frame with Woolpile	Standard	12.5'	Box	10/pcs	\$702.66
EA16289-150-XXX	144EXT Extruded Aluminum Frame	Standard	12.5'	Box	10/pcs	\$678.10
CR243R/L	Corner	Standard		Box	600/pcs	\$1,513.12
XRL478PNA**	Plastic Roller	Mill		Box	100/box	\$186.72
XHNC844R/L-L48**	Inset Black Composite Handle, Left	Black		Box	100/pcs	\$1,147.68
HB-1115-9	Standard Strike Bag (Not Shown)			Box	100/box	\$400.00
WP7XX187X500-F	.500" High Woolpile	Standard	1,500'	Roll	1,500'	\$1,260.00

**Available in bulk quantities

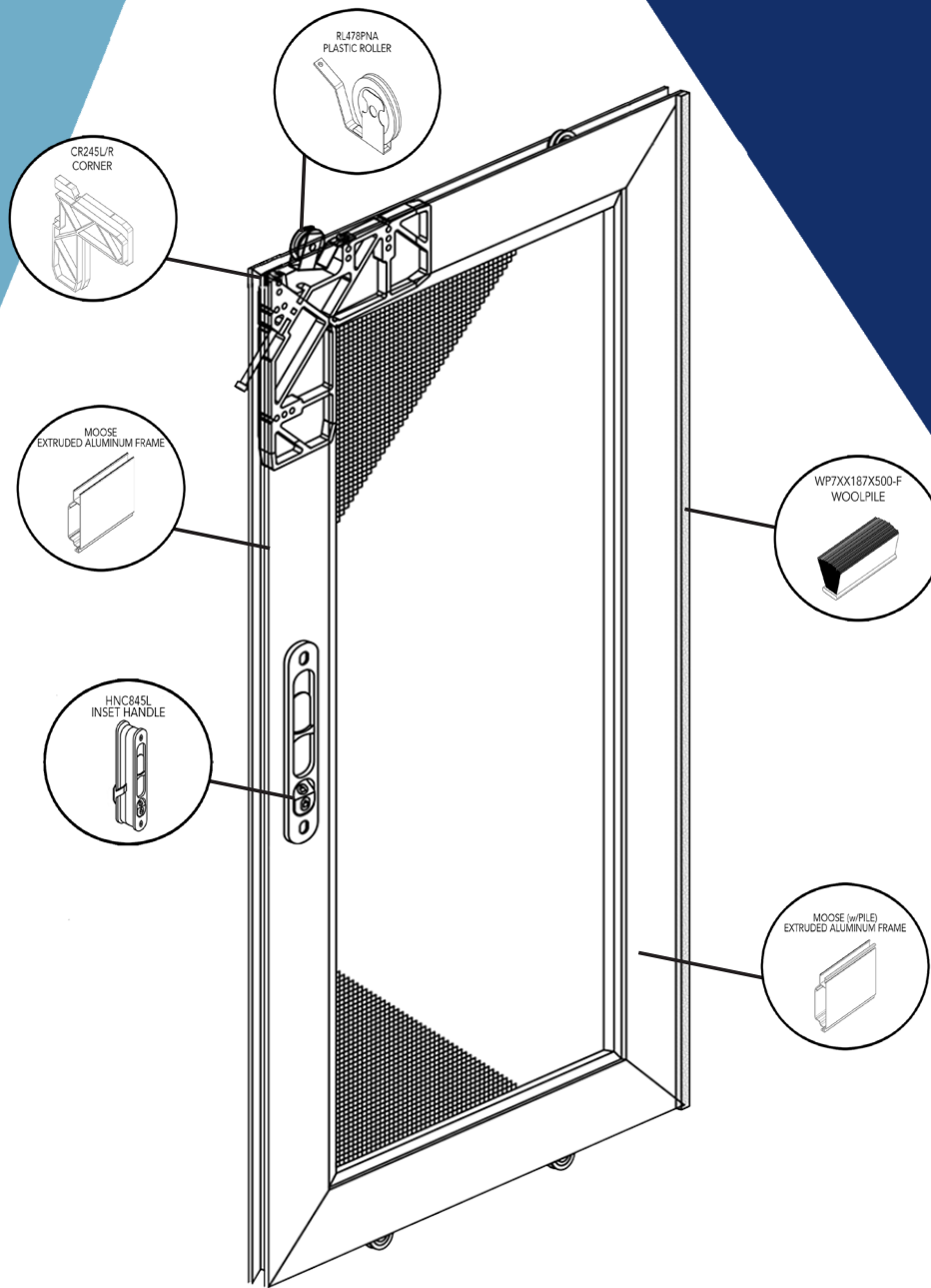

Standard Colors:

XXX in part numbers are place holders for Color Code



Part #	Description	QTY	List Price
MOOSE	Fully Assembled	United Inch	\$2.0342
RL478S	Steel Roller	Optional	\$20.00/Unit
RL478ST	Stainless Steel Roller	Optional	\$40.00/Unit

Part #	Description	Color	Length	UOM	QTY	List Price
EA17011-150-XXX	MOOSE Extruded Aluminum Frame with Woolpile	Standard	12.5'	Box	10/pcs	\$7,902.72
EA17010-150-XXX	MOOSE Extruded Aluminum Frame	Standard	12.5'	Box	10/pcs	\$904.12
CR245R/L	Corner	Standard		Box	200/pcs	\$1,134.80
XRL478PNA**	Plastic Roller	Mill		Box	100/box	\$186.72
XHNC845R/L-L48**	Inset Black Composite Handle, Left	Black		Box	100/pcs	\$1,221.60
HB-1115-9	Standard Strike Bag (Not Shown)			Box	100/box	\$400.00
WP7XX187X500-F	.500" High Woolpile	Standard	1,500'	Roll	1,500'	\$1,260.00

**Available in bulk quantities

121SMFIT - Standard Multi-Fit Patio Door

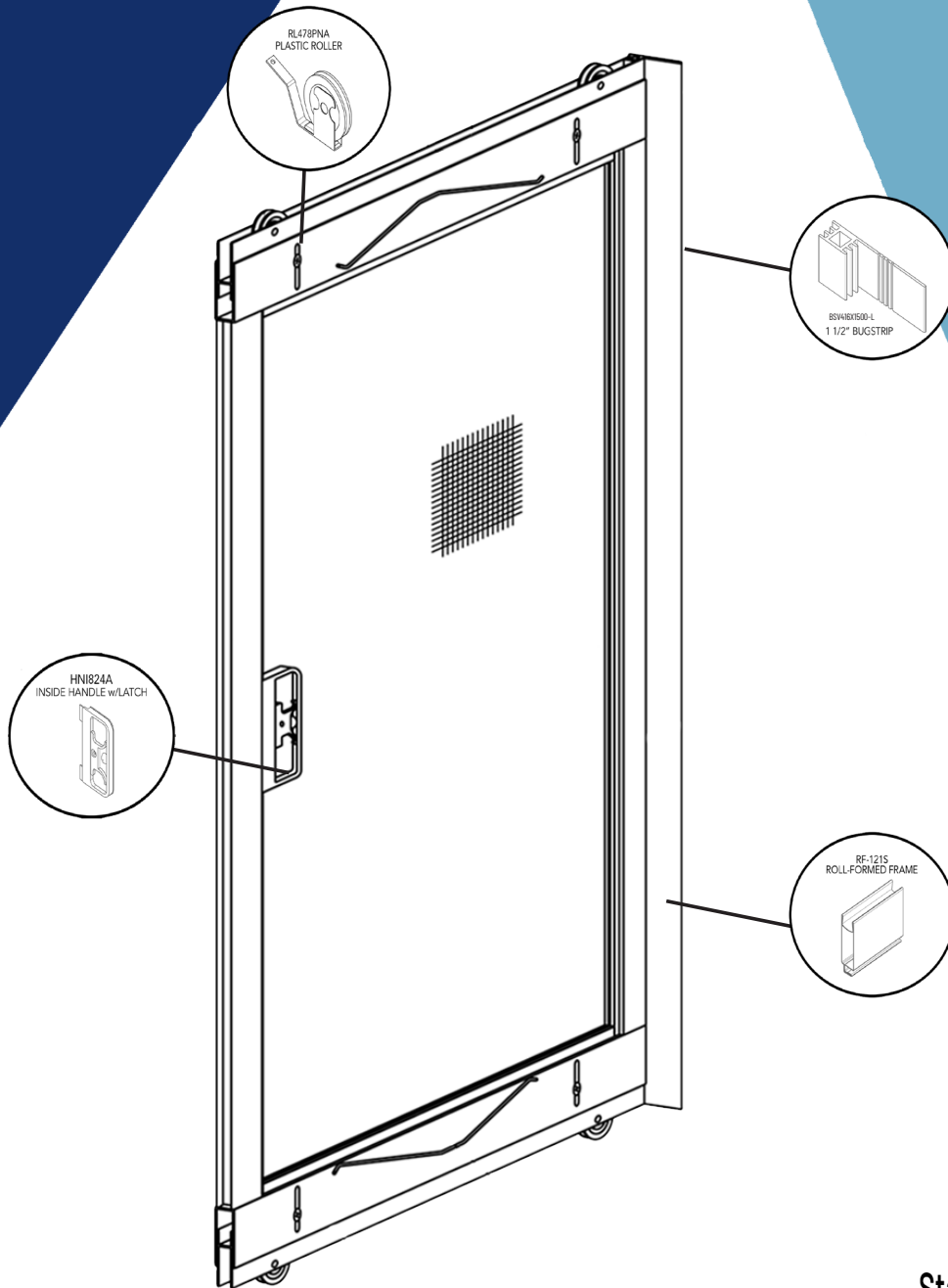

Standard Colors



Series	Fully Assembled Screen	Width	List Price
121SMFIT	Standard Multi-Fit Patio Door	30"	\$143.82
121SMFIT	Standard Multi-Fit Patio Door	36"	\$155.80
121SMFIT	Standard Multi-Fit Patio Door	48"	\$179.78

Part #	Description	Color	Length	UOM	QTY	List Price
SR121-19-100XXX	121 Steel Frame	Standard (No Black)	8.1'	Box	48/pcs	\$1,947.97
XHNI824A-L48**	Inside Handle w. Latch	Black		Box	100/box	\$243.22
XHNI824I-L48**	Outside Handle (Not Shown)	Black		Box	100/box	\$156.98
XRL478PNA	Plastic Roller	Mill		Box	100/box	\$186.72
BSV416X1500-L	1.5" Bug Strip	Black	286'	Roll	286'	\$297.20

**Available in bulk quantities

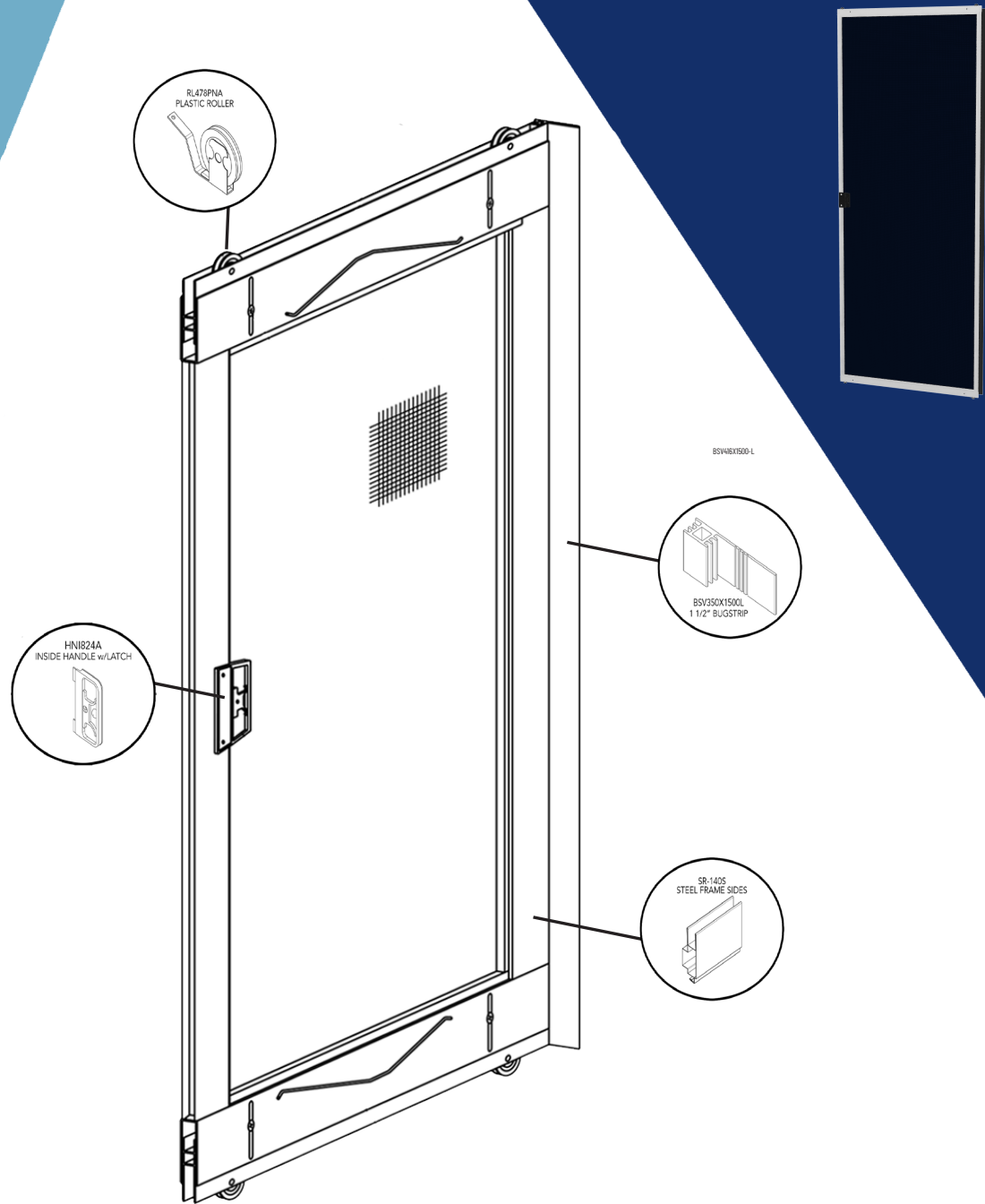

Standard Colors



Series	Fully Assembled Screen	Width	List Price
140SMFIT	Premium Multi-Fit Patio Door	30"	\$154.76
140SMFIT	Premium Multi-Fit Patio Door	36"	\$164.42
140SMFIT	Premium Multi-Fit Patio Door	48"	\$183.76

Part #	Description	Color	Length	UOM	QTY	List Price
SR140-19-100XXX	140 Steel Frame	Standard (No Black)	8.1'	Box	27/Box	\$1,465.20
XHNI824A-L48**	Inside Handle w. Latch	Black		Box	100/box	\$243.22
XHNI824I-L48**	Outside Handle (Not Shown)	Black		Box	100/box	\$156.98
XRL478PNA	Plastic Roller	Mill		Box	100/box	\$186.72
BSV416X1500-L	1.5" Bug Strip	Black	286'	Roll	286'	\$297.20

**Available in bulk quantities

MOOSEFIT - Ultimate Multi-Fit Patio Door

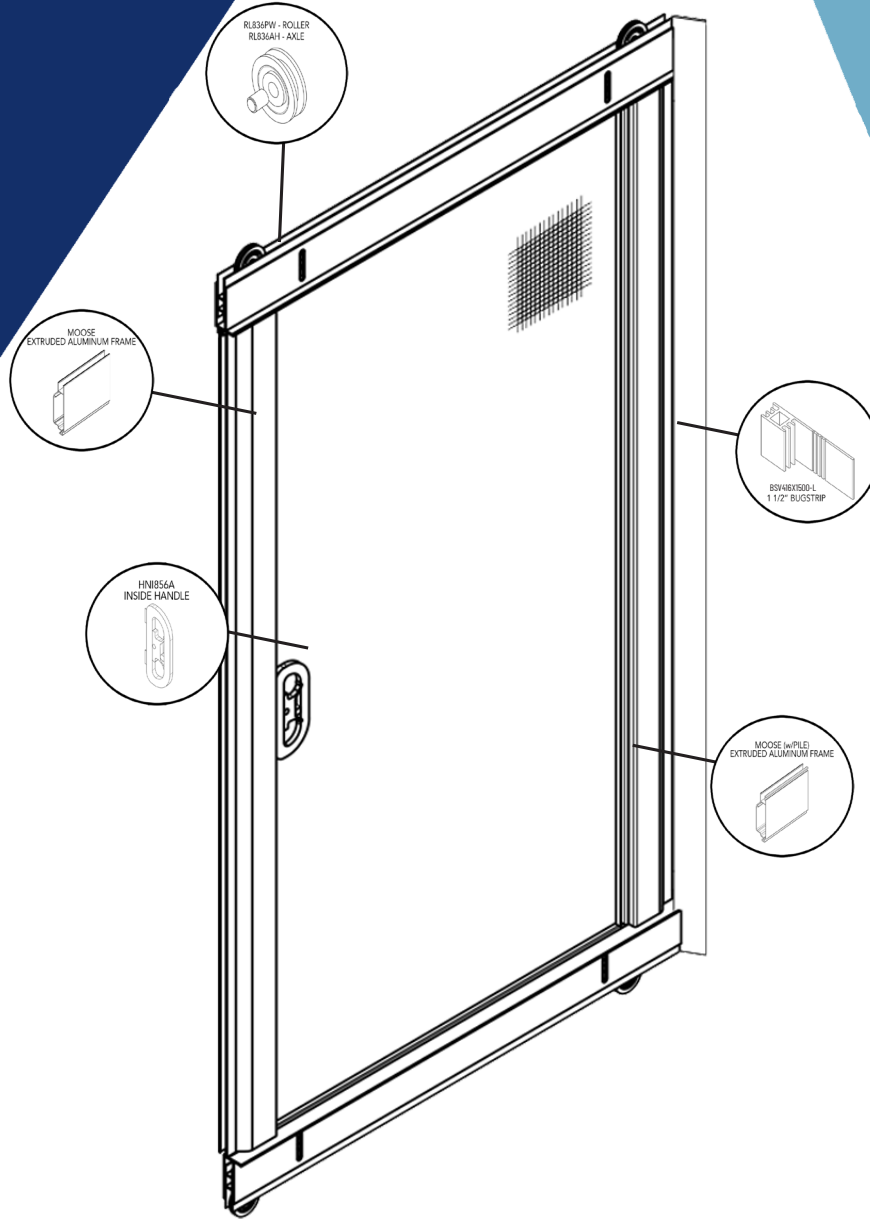

Standard Colors



Series	Fully Assembled Screen	Width	List Price
MOOSEFIT	Ultimate Multi-Fit Patio Door	30"	\$229.74
MOOSEFIT	Ultimate Multi-Fit Patio Door	36"	\$242.22
MOOSEFIT	Ultimate Multi-Fit Patio Door	48"	\$267.18

Part #	Description	Color	Length	UOM	QTY	List Price
EA17011-150-XXX	MOOSE Extruded Aluminum Frame with Woolpile	Standard	12.5'	Box	10/pcs	\$7,902.72
EA17010-150-XXX	MOOSE Extruded Aluminum Frame	Standard	12.5'	Box	10/pcs	\$904.12
XHNI856A-L48	Inside Handle	Black		Box	100/pcs	\$333.60
XHNI858-L48	Outside Handle (Not Shown)	Black		Box	100/pcs	\$358.40
XRL836PW	Plastic Roller	White		Box	100/box	\$92.06
XRL836AH	Steel Axle	Mill		Box	100/Box	\$79.12
BSV416X1500-L	1.5" Bug Strip	Black	286'	Roll	286'	\$297.20

**Available in bulk quantities

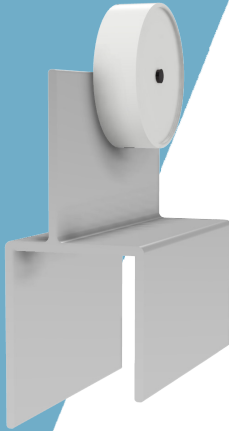

EAOP033-150-XXX
Top Hung Adapter

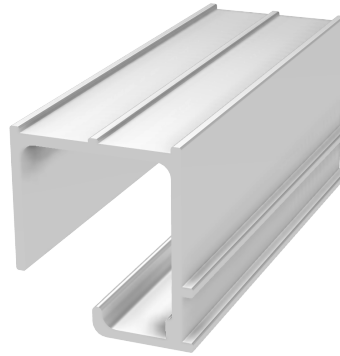

EAOP007-150-XXX
Top Hung Track

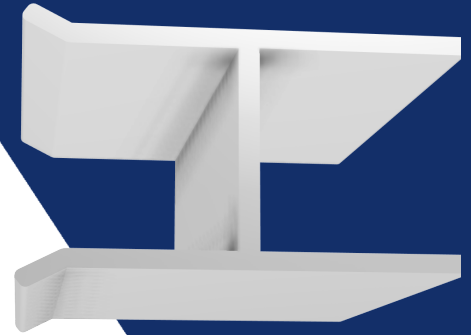

EA1255-100-XXX
Astragal

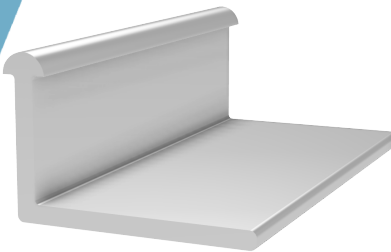

EA42546-120-XXX
Sill Track

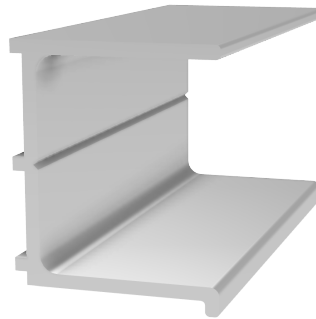

EAOP006-166-XXX
Jamb Track

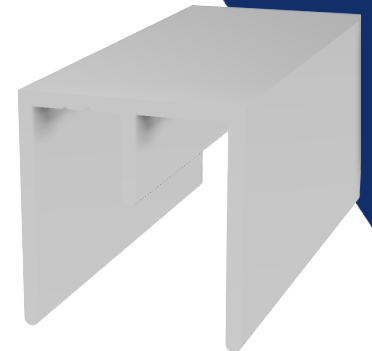

EA1002-120-XXX
Top Track

Standard Colors:

XXX in part numbers are
place holders for Color Code



Part #	Description	Color	Length	UOM	QTY	List Price
EAOP033-150-XXX	Top Hung Adapter	Standard	150"	Box	20/pcs	\$1,184.26
EAOP007-144-XXX	Top Hung Track	Standard	144"	Box	20/pcs	\$1,074.59
EA1255-100-XXX	Astragal	Black, White	100"	Box	20/pcs	\$765.60
EA42546-120-XXX	Sill Track	Standard	120"	Box	20/pcs	\$333.70
EAOP006-166-XXX	Jamb Track	Standard	166"	Box	20/pcs	\$949.52
EA1002-120-XXX	Top Track	Standard	120"	Box	20/pcs	\$770.35

Additional Charges

Cut-To-Fit	+\$6.00/piece
Cut and Fabricated	+\$12.00/piece

The Signature is an out-swing screen door which complements “top of the line” French Patio doors. The premium engineering of this screen door was specifically designed for easy installation on elite In-Swing French doors.

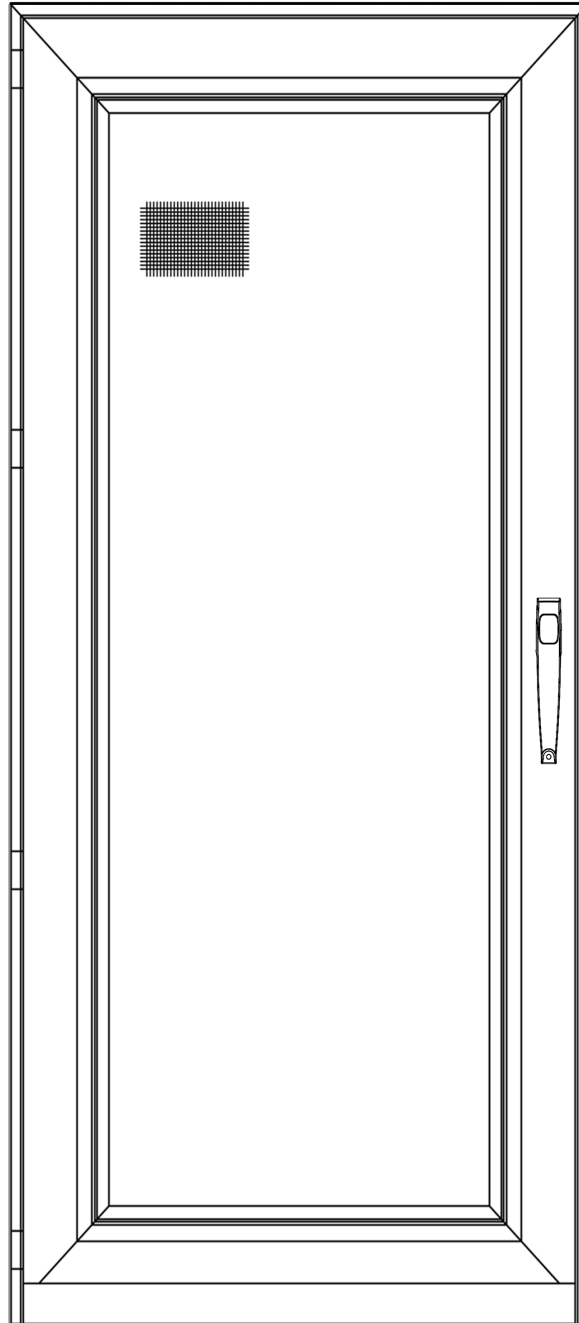

Standard Colors:

XXX in part numbers are
place holders for Color Code

White (C01)



Black (L48)



Clay (A22)



Almond (A29)



Bronze (B16)



Part #	Description	QTY	List Price
SIGNATURE.SGL	Single Swing Door	United Inch	\$6.0434

The Signature's 3" wide, sturdy, extruded frame makes it an excellent choice for 6'8" & 8'0" high doors, as well as custom widths and heights. The screening is attached directly to the door frame, which eliminates the need for unsightly clips to retain a separate screen in place.

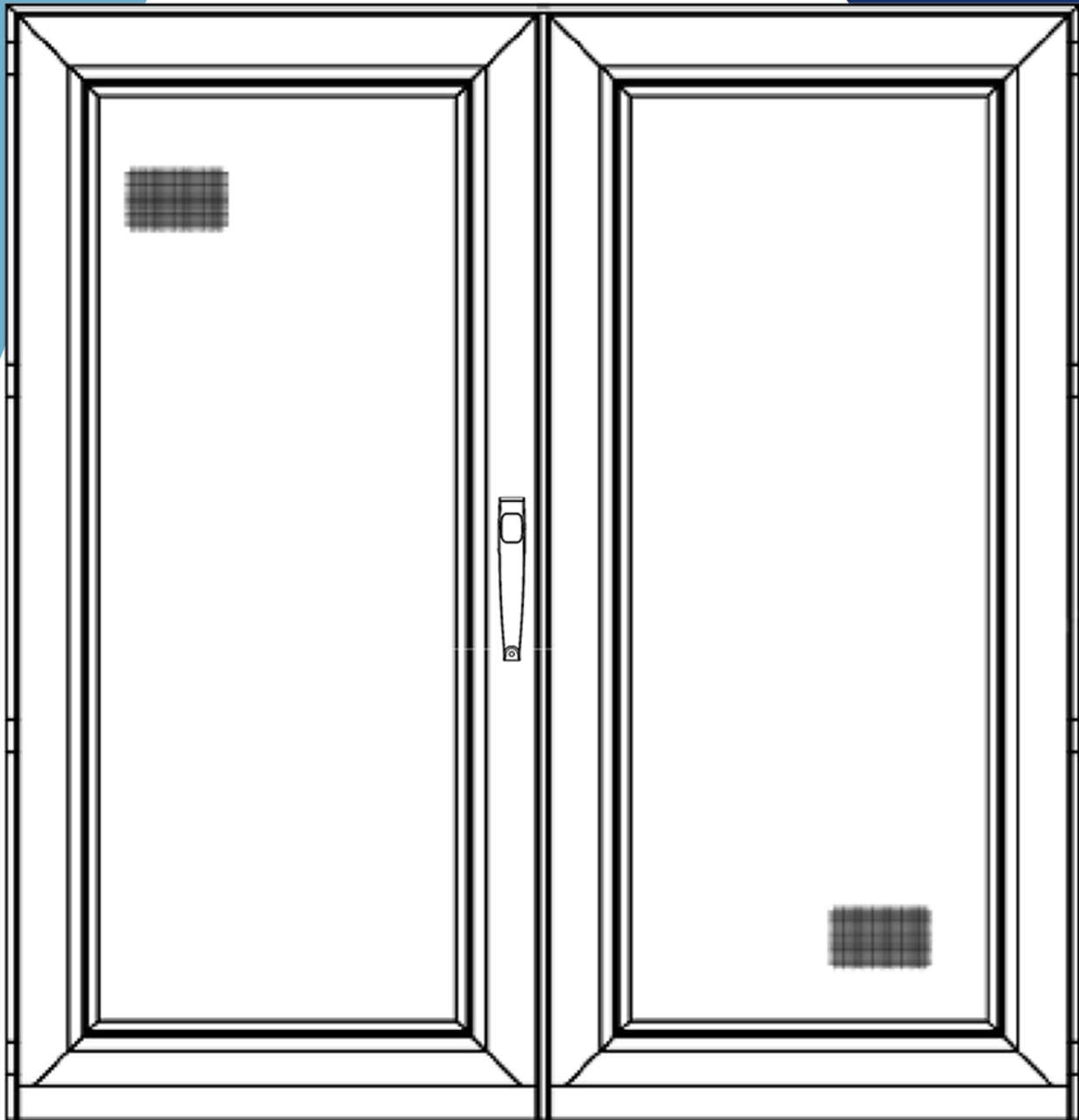

Standard Colors:

XXX in part numbers are place holders for Color Code

White (C01)



Black (L48)



Clay (A22)



Almond (A29)



Bronze (B16)



Part #	Description	QTY	List Price
SIGNATURE.DBL	Double Swing Door	United Inch	\$8.3001



KITS & COMPONENTS



America's Total Screen Authority

Ultimate Multi-Fit Knock-Down Patio Door Kit

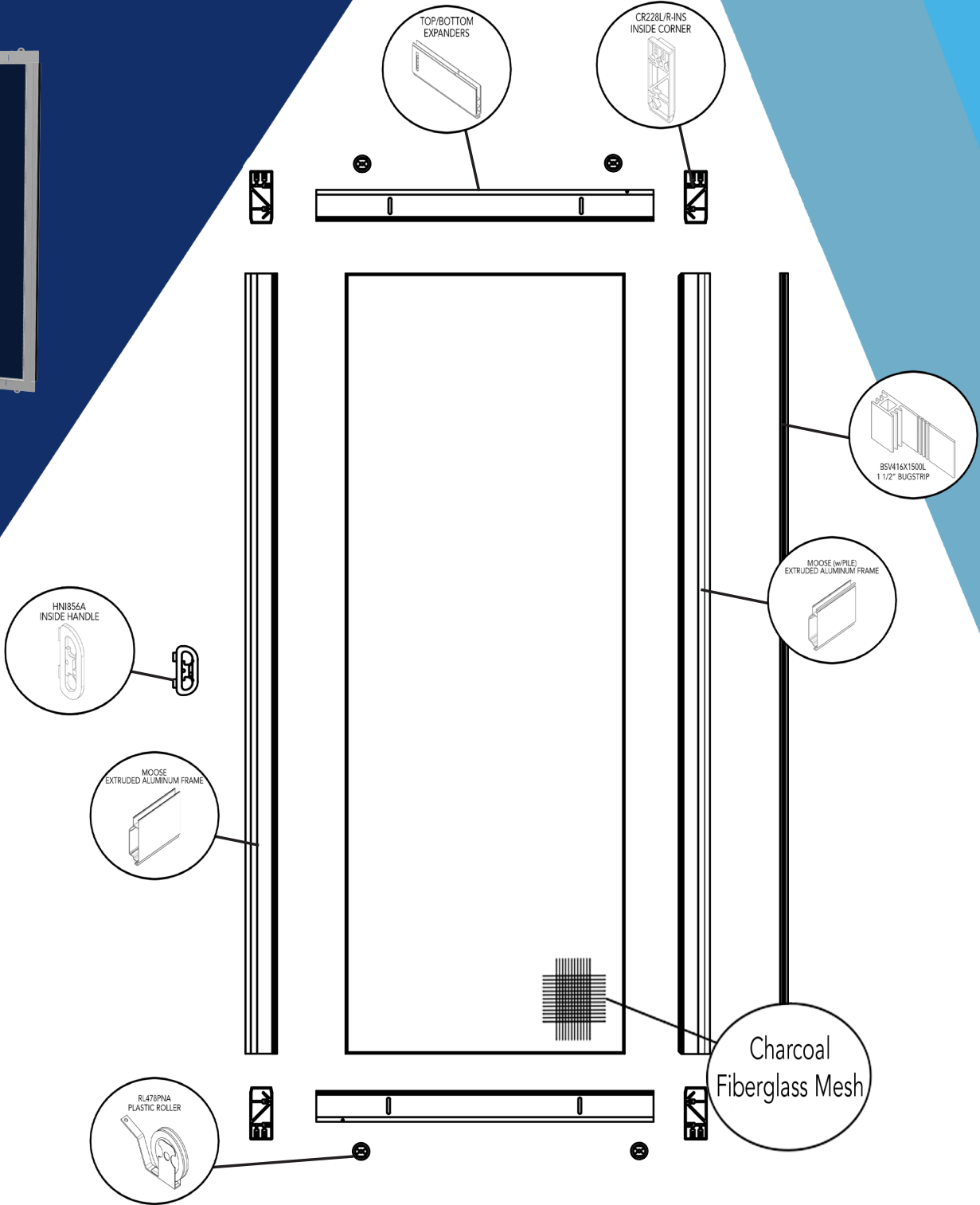

Standard Colors

White (C01)

Bronze (B16)

Part #	Description	QTY	List Price
MOOSEMFIT	Known-Down Ultimate Multi-Fit Patio Door Screen	1 per box	\$1.6187/UI

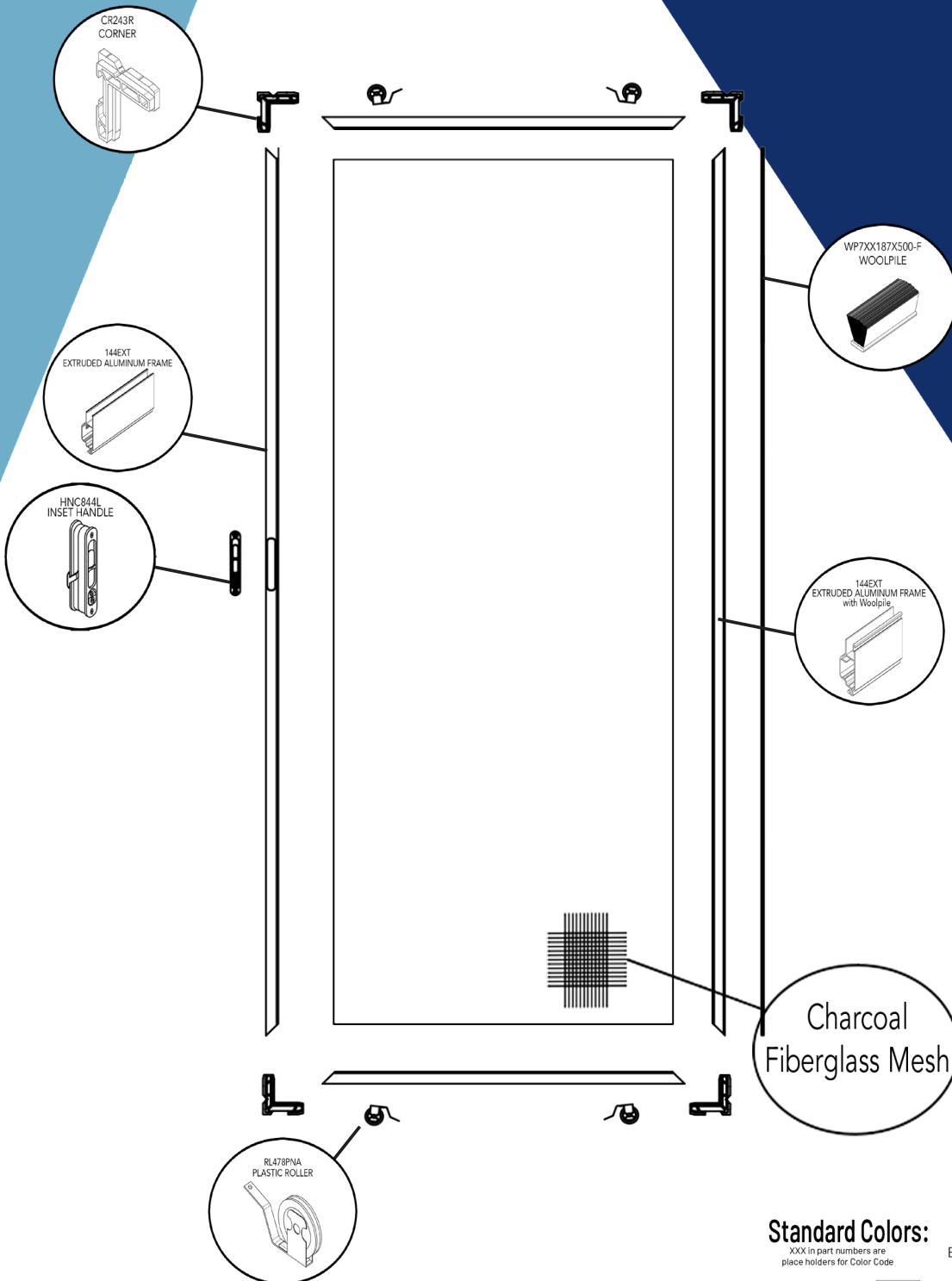

Standard Colors:

XXX in part numbers are place holders for Color Code

White (C01)

Almond (A29)

Black (L48)

Clay (A22)

Bronze (B16)

Part #	Description	QTY	List Price
KD.144EXT	Unassembled (packaging included)	1 per box	\$2.69/UI

Customizable Distributor Knock-Down Kit

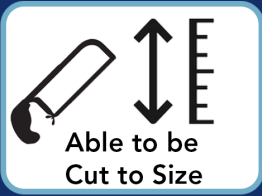

Standard Colors:

XXX in part numbers are
placeholders for Color Code

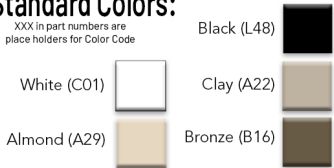

Part #	Description	QTY	List Price (Packaging Included)
144KDTB1-XXX	31" x 81"	1 per box	\$181.29
144KDTB1-XXX	37" x 81"	1 per box	\$191.01
144KDTB1-XXX	49" x 81"	1 per box	\$210.43
144KDTB1-XXX	37" x 97"	1 per box	\$216.91
144KDTB1-XXX	49" x 97"	1 per box	\$236.33

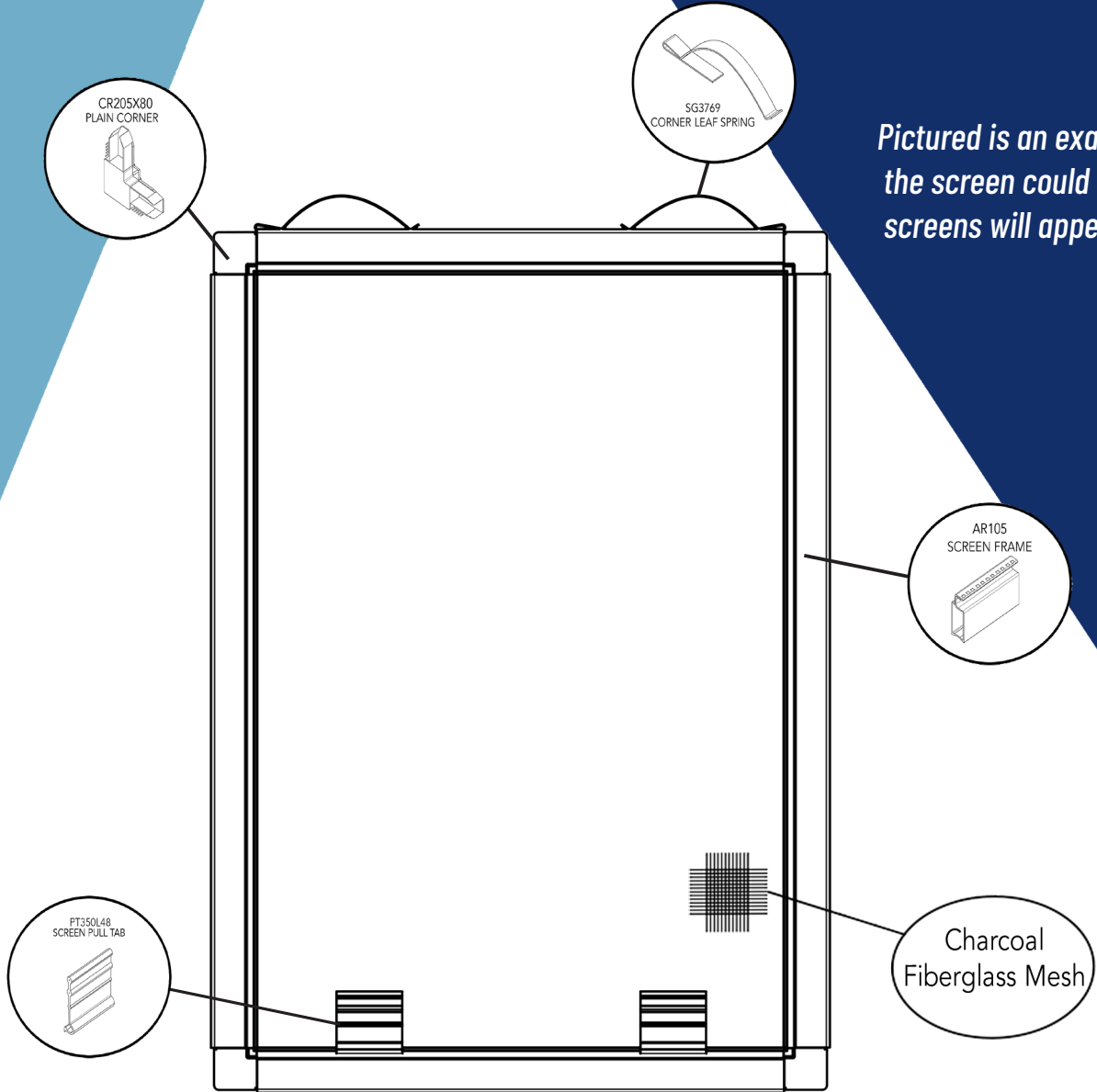

Pictured is an example of how the screen could look. Not all screens will appear this way.

Available Colors



Part #	Description	Color	Length	List Price
FG-WDKIT36-C	36" Replacement Kit, No Mesh	White	36"	\$35.50
FG-WDKIT36-B	36" Replacement Kit, No Mesh	Bronze	36"	\$35.50
FG-WDKIT48-C	48" Replacement Kit, No Mesh	White	48"	\$39.90
FG-WDKIT48-B	48" Replacement Kit, No Mesh	Bronze	48"	\$39.90
FG-WDKIT60-C	60" Replacement Kit, No Mesh	White	60"	\$44.38
FG-WDKIT60-B	60" Replacement Kit, No Mesh	Bronze	60"	\$44.38
FG-WDKIT36M-C	36" Replacement Kit, Mesh Included	White	36"	\$40.36
FG-WDKIT36M-B	36" Replacement Kit, Mesh Included	Bronze	36"	\$40.36
FG-WDKIT48M-C	48" Replacement Kit, Mesh Included	White	48"	\$48.52
FG-WDKIT48M-B	48" Replacement Kit, Mesh Included	Bronze	48"	\$48.52
FG-WDKIT60M-C	60" Replacement Kit, Mesh Included	White	60"	\$57.86
FG-WDKIT60M-B	60" Replacement Kit, Mesh Included	Bronze	60"	\$57.86

**Available in bulk quantities

BUG STRIPS

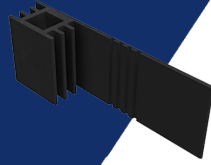

BSV350X1500-L

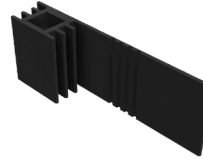

BSV416X1500-L

Part #	Description	Color	Length	UOM	QTY	List Price
BSV350X1500-L	1.5" Bug Strip	Black	286'	Roll	286'	\$133.68
BSV416X1500-L	1.5" Bug Strip	Black	286'	Roll	286'	\$297.20

CAPS



PL308-XXX

Part #	Description	Color	UOM	QTY	List Price
PL308-L48	Plunger Cap	Black	Box	10,000	\$1,344.00

CLIPS

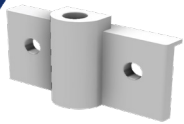

CL3420-XXX



CL555L-TT

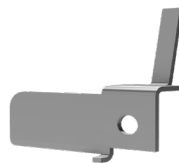

CL555R-TT



CL556-TT

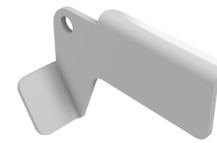

CL4119LC



CL4119RC

Part #	Description	Color	UOM	QTY	List Price
CL3420-XXX	Plunger Housing	White or Bronze	Box	1,000	\$880.00
CL555L-TT	Left Swivel Clip	Mill	Box	3,000	\$7,788.00
CL555R-TT	Right Swivel Clip	Mill	Box	3,000	\$7,788.00
CL556-TT	Top Swivel Clip	Mill	Box	5,000	\$11,660.00
CL4119LC	Swivel Clip (Left)	White	Box	2,000	\$2,686.32
CL4119RC	Swivel Clip (Right)	White	Box	2,000	\$2,686.32

CROSSBARS

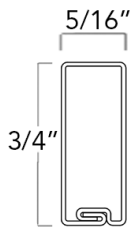

AR368-16-12XXX

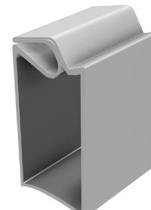
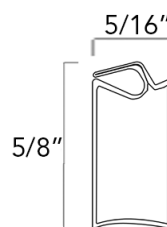

AR109-16-11XXX

Standard Colors:

XXX in part numbers are place holders for Color Code

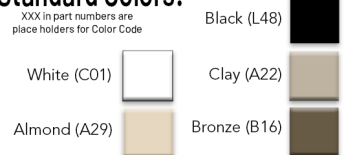

Part #	Description	Color	Length	UOM	QTY	List Price
AR368-16-12XXX	Crossbar	Standard	12.5'	Box	152/pcs	\$1,583.36
AR109-16-11XXX	Crossbar	Standard	11.5'	Box	153/pcs	\$1,593.72

CORNERS

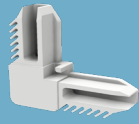

CR201X78-XXX

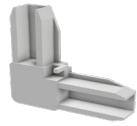

CR202X775-XXX

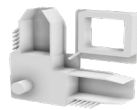

CR205PSX80-XXX



CR205PTX80-XXX



CR205X80-XXX

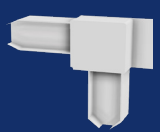

CR232-202L-XXX

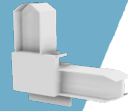

CR232-202R-XXX



CR232-XXX



CR233-202L

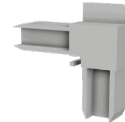

CR233-202R

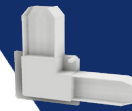

CR233-XXX



CR236FPL-XXX

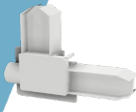

CR236FPR-XXX



CR243L



CR243R



CR245L



CR245R



CR54663-328-INS



CR54665-INS



CR54666-INS



CR54667-INS



CR54668-INS



CRS221-USP



CRS221-USS



CR280201-INS

Part #	Description	Color	UOM	QTY	List Price
CR201X78-XXX	Outside Corner	Standard	Box	1,500/pcs	\$1,269.20
CR202X775-XXX	Outside Corner	Standard	Box	1,500/pcs	\$2,277.00
CR205PSX80-XXX	Corner Pull w/Stop	Standard	Box	1500/pcs	\$551.88
CR205PTX80-XXX	Corner w/Pull	Standard	Box	1500/pcs	\$551.88
CR205X80-XXX	Plain Corner	Standard	Box	1500/pcs	\$405.72
CR232-202L-XXX	Corner	Standard	Bag	2,000/pcs	\$1,886.22
CR232-202R-XXX	Corner	Standard	Bag	2,000/pcs	\$1,886.22
CR232-XXX	Plain Corner	Standard	Box	1,500/pcs	\$1,886.22
CR233-202L	Plain Corner	Standard	Box	1,500/pcs	\$1,886.22
CR233-202R	Plain Corner	Standard	Box	1,500/pcs	\$1,886.22
CR233-XXX	Plain Corner	Standard	Box	2,500/pcs	\$2,058.00
CR236FPL-XXX	Fixed Pin Corner	Standard	Bag	2,000/pcs	\$1,805.58
CR236FPR-XXX	Fixed Pin Corner	Standard	Bag	2,000/pcs	\$1,805.58
CR243L	Corner	Standard	Box	600/pcs	\$1,513.12
CR243R	Corner	Standard	Box	600/pcs	\$1,513.12
CR245L	Corner	Standard	Box	200/pcs	\$1,134.80
CR245R	Corner	Standard	Box	200/pcs	\$1,134.80
CR54663-328-INS	Corner	Mill	Box	1,000/pcs	\$503.36
CR54665-INS	Inside Corner	Mill	Box	2,500/pcs	\$924.64
CR54666-INS	Inside Corner	Mill	Box	4,000/pcs	\$1,463.68
CR54667-INS	Corner	Mill	Box	2,000/pcs	\$877.36
CR54668-INS	Inside Corner	Mill	Box	4,000/ea	\$1,463.68
CRS221-USP	Corner/Plastic Roller	Standard	Box	250/pcs	\$1,936.20
CRS221-USS	Corner/Steel Roller	Standard	Box	250/pcs	\$2,494.80
CR280201-INS	Inside Corner	Mill	Box	3000/pcs	\$7,682.40

Standard Colors:

XXX in part numbers are
place holders for Color Code

White (C01)

Almond (A29)

Black (L48)

Clay (A22)

Bronze (B16)

HANDLES



HNC844L-L48 HNC844R-L48 HNC845L-L48 HNC845R-L48



HNI824A-L48 HNI824I-L48 HNI856A-L48 HNI858-L48

Part #	Description	Color	UOM	QTY	List Price
HNI824A-L48	Inside Handle w. Latch	Black	Box	1,000/box	\$2,033.64
HNI824I-L48	Outside Handle	Black	Box	1,000/box	\$1302.64
HNI856A-L48	Inside Handle	Black	Box	500/pcs	\$1504.80
HNI858-L48	Outside Handle	Black	Box	350/pcs	\$1045.04
HNC844L-L48	Inset Black Composite Handle, Left	Black	Box	100/pcs	\$1,098.46
HNC844R-L48	Inset Black Composite Handle, Right	Black	Box	100/pcs	\$1,098.46
HNC845L-L48	Inset Black Composite Handle, Left	Black	Box	100/pcs	\$1,226.40
HNC845R-L48	Inset Black Composite Handle, Right	Black	Box	100/pcs	\$1,226.40

LATCHES



CL10516C CL082-L48 HNS481-4 HNS481-6 HW1025-XXX
 CL145L CL145R CL339R CL339L

Part #	Description	Color	UOM	QTY	List Price
CL10516C	Screen Latch	Standard	Box	1,000/pcs	\$1,118.88
CL082-L48	Swivel Latch	Mill	Box	3,500/pcs	\$1,234.80
HNS481-4	Standard T Latch	Mill	Box	8,000/box	\$9,945.60
HNS841-6	Standard T-Latch	Mill	Box	8,000/box	\$9,945.60
HW1025-XXX	Plastic Slide Latch	White or Black	Box	10,000/box	\$3,444.00
CL145L-S00	Screen Latch	Clear	Box	3,000/pcs	\$1,320.00
CL145R-S00	Screen Latch	Clear	Box	3,000/pcs	\$1,320.00
CL339R	Butterfly Latch	Mill	Box	4,000/pcs	\$9,856.00
CL339L	Butterfly Latch	Mill	Box	4,000/pcs	\$9,856.00

LEAF SPRINGS



SG376-SS187



SG402-AW



SG3769



SG11140

Part #	Description	Color	UOM	QTY	List Price
SG376-SS187	Leaf Spring	Mill	Box	2,500/ea	\$2,520.00
SG402-AW	Leaf Spring	Mill	Box	5,000/pcs	\$1,138.20
SG3769	Leaf Spring	Mill	Box	10,000/pcs	\$3,040.80
SG11140	Overlapping Leaf Spring	Mill	Box	6,500/pcs	\$2,784.60

PINS



PL1012A-CL

Part #	Description	Color	UOM	QTY	List Price
PL1012A-CL	Push Pin	Mill	Box	2,000/pcs	\$520.80

PLUNGERS



PL315

Part #	Description	Color	UOM	QTY	List Price
PL315	Plunger	Mill	Box	10,000/pcs	\$3,528.00

PULL TABS



HNP411-XXX



PT350L48



PT342S00

Part #	Description	Color	UOM	QTY	List Price
HNP411-XXX	Pull Tab	White or Black	Box	2,500/pcs	\$6,930.00
PT342S00	Clear Pull Tab	Clear	Box	1,700/pcs	\$372.70
PT350L48	Pull Tab	Black	Box	4,000/pcs	\$457.60

RIVETS

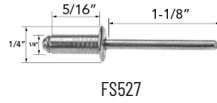

Part #	Description	Color	UOM	QTY	List Price
FS527	Rivet	Mill	Box	10,000/pcs	\$1,201.20

ROLLERS



RL478P



RL478PNA



RL478S



RL836PW - ROLLER
RL836AH - AXLE

Part #	Description	Color	UOM	QTY	List Price
RL478P	Composite Roller	Mill	Box	2,500/box	\$8,000.00
RL478PNA	Plastic Roller	Mill	Box	2,500/box	\$3,432.00
RL478S	Steel Roller	Mill	Box	2,500/box	\$12,250.00
RL836PW	Plastic Roller	White	Box	3,000/Box	\$1,021.68
RL836AH	Steel Axle	Mill	Box	10,000/Box	\$2,112.00

SCREEN FRAMES

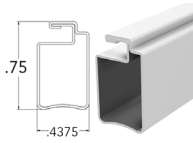

AR101-16-12XXX

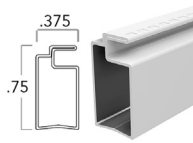

AR102-16-12XXX

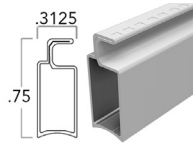

AR105-16-12XXX

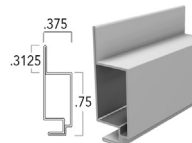

AR132-16-12XXX

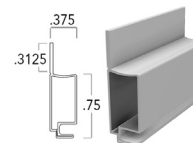

AR133-16-12XXX

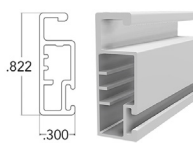

EA56771-150-XXX

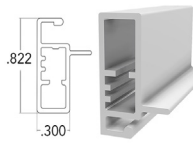

EA56773-150-XXX

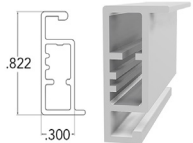

EA56776-150-XXX

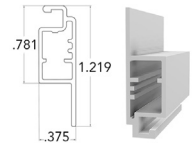

EA56780-150-XXX

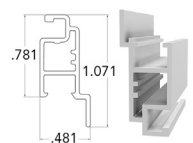

EA56781-150-XXX

Part #	Description	Color	Length	UOM	QTY	List Price
AR101-16-12XXX	Screen Frame	Standard	12.5'	Box	112/pcs	\$1,293.64
AR102-16-12XXX	Screen Frame	Standard	12.5'	Box	128/pcs	\$1,419.08
AR105-16-12XXX	Screen Frame	Standard	12.5'	Box	152/pcs	\$1,583.72
AR132-16-12XXX	Flange Screen Frame	Standard	12.5'	Box	105/pcs	\$1,484.36
AR133-16-12XXX	Flange Screen Frame	Standard	12.5'	Box	105/pcs	\$1,525.52
EA56771-150-XXX	Pile Rail	Standard	12.5'	Box	20/pcs	\$734.14
EA56773-150-XXX	Pull Rail	Standard	12.5'	Box	20/pcs	\$559.24
EA56776-150-XXX	Edge Stop Rail	Standard	12.5'	Box	20/pcs	\$664.62
EA56780-150-XXX	Flange Rail	Standard	12.5'	Box	20/pcs	\$878.02
EA56781-150-XXX	Short Flange Rail	Standard	12.5'	Box	20/pcs	\$779.68

SCREEN FRAMES CONT.

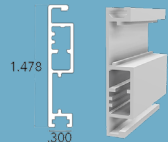

EA56795-150-XXX

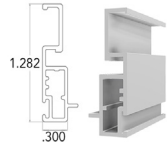

EA56796-150-XXX

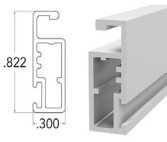

EA56797-150-XXX

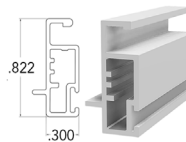

EA56799-150-XXX

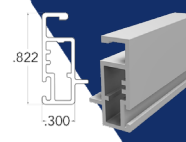

EA56800-150-XXX

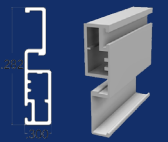

EA56801-150-XXX

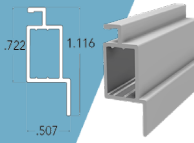

EA38654-150-XXX

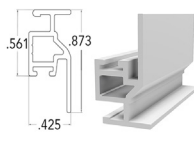

EA56778-150-XXX

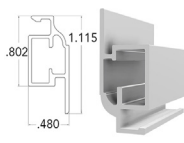

EA56788-150-XXX

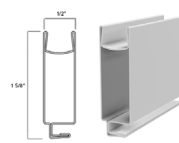

SR121-19-100XXX

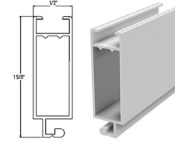

EA1749-150-XXX

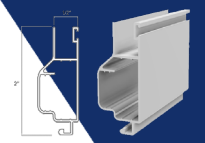

EA16282-150-XXX

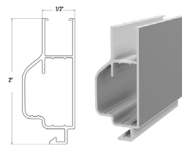

EA16289-150-XXX

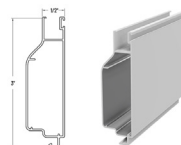

EA17011-150-XXX

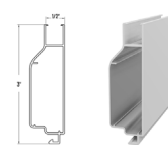

EA17010-150-XXX

Standard Colors:

XXX in part numbers are
piece holders for Color Code

White (C01)

Almond (A29)

Black (L48)

Clay (A22)

Bronze (B16)

Part #	Description	Color	Length	UOM	QTY	List Price
EA56795-150-XXX	Latch Rail	Standard	12.5'	Box	20/pcs	\$991.54
EA56796-150-XXX	Lift Rail w/Pile and Stop	Standard	12.5'	Box	20/pcs	\$851.62
EA56797-150-XXX	Pile Rail	Standard	12.5'	Box	20/pcs	\$658.24
EA56799-150-XXX	Stop Rail w/Pile	Standard	12.5'	Box	20/pcs	\$777.92
EA56800-150-XXX	Stop Rail w/Pile	Standard	12.5'	Box	20/pcs	\$658.90
EA56801-150-XXX	Lift Rail w/Pile	Standard	12.5'	Box	20/pcs	\$821.04
EA38654-150-XXX	Casement Frame	Standard	12.5'	Box	20/pcs	\$935.66
EA56778-150-XXX	Screen Frame	Standard	12.5'	Box	20/ea	\$797.28
EA56788-150-XXX	Casement Frame	Standard	12.5'	Box	20/pcs	\$875.82
SR121-19-100XXX	121 Steel Frame	Standard (No Black)	8.1'	Box	20/pcs	\$971.52
EA1749-150-XXX	199EXT Extruded Aluminum Frame	Standard	12.5'	Box	10/pcs	\$775.60
EA16282-150-XXX	144EXT Extruded Aluminum Frame with Woolpile	Standard	12.5'	Box	10/pcs	\$702.66
EA16289-150-XXX	144EXT Extruded Aluminum Frame	Standard	12.5'	Box	10/pcs	\$678.10
EA17011-150-XXX	MOOSE Extruded Aluminum Frame with Woolpile	Standard	12.5'	Box	10/pcs	\$928.70
EA17010-150-XXX	MOOSE Extruded Aluminum Frame	Standard	12.5'	Box	10/pcs	\$904.12

SCREEN MESH

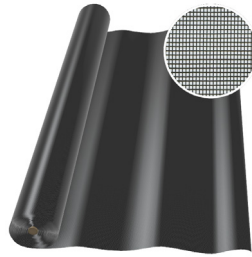

CHAR FIBER MESH

* See page 6 for upgraded mesh options

Part #	Description	Color	Length	UOM	QTY	List Price
MSFG18X100-L00	18" x 100' Char Fiber Mesh	Charcoal	100'	Roll	150 ft ²	\$92.40
MSFG20X100-L00	20" x 100' Char Fiber Mesh	Charcoal	100'	Roll	166.67 ft ²	\$102.67
MSFG24X100-L00	24" x 100' Char Fiber Mesh	Charcoal	100'	Roll	200 ft ²	\$123.20
MSFG28X100-L00	28" x 100' Char Fiber Mesh	Charcoal	100'	Roll	233.33 ft ²	\$143.73
MSFG32X100-L00	32" x 100' Char Fiber Mesh	Charcoal	100'	Roll	266.67 ft ²	\$164.27
MSFG35X100-L00	35" x 100' Char Fiber Mesh	Charcoal	100'	Roll	291.67 ft ²	\$179.67
MSFG36X100-L00	36" x 100' Char Fiber Mesh	Charcoal	100'	Roll	300 ft ²	\$184.80
MSFG40X100-L00	40" x 100' Char Fiber Mesh	Charcoal	100'	Roll	333.33 ft ²	\$205.33
MSFG48X100-L00	48" x 100' Char Fiber Mesh	Charcoal	100'	Roll	400 ft ²	\$246.40
MSFG24X600-L00	24" x 600' Char Fiber Mesh	Charcoal	600'	Roll	1,200 ft ²	\$687.46
MSFG26X600-L00	26" x 600' Char Fiber Mesh	Charcoal	600'	Roll	1,300 ft ²	\$730.30
MSFG28X600-L00	28" x 600' Char Fiber Mesh	Charcoal	600'	Roll	1,400 ft ²	\$801.86
MSFG32X600-L00	32" x 600' Char Fiber Mesh	Charcoal	600'	Roll	1,600 ft ²	\$916.28
MSFG36X600-L00	36" x 600' Char Fiber Mesh	Charcoal	600'	Roll	1,800 ft ²	\$1,031.18
MSFG48X600-L00	48" x 600' Char Fiber Mesh	Charcoal	600'	Roll	2,400 ft ²	\$1,334.60
MSFG60X600-L00	60" x 600' Char Fiber Mesh	Charcoal	600'	Roll	3,000 ft ²	\$1,668.25

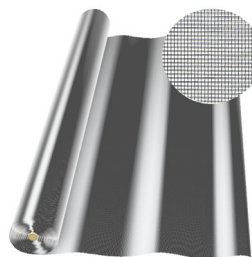

ALUMINUM WIRE MESH

Part #	Description	Color	Length	UOM	QTY	List Price
MSAL24X100-L00	24" x 100' Aluminum Wire Mesh	Charcoal	100'	Box	200 ft ²	\$320.00
MSAL30X100-L00	30" x 100' Aluminum Wire Mesh	Charcoal	100'	Box	250 ft ²	\$313.44
MSAL32X100-L00	32" x 100' Aluminum Wire Mesh	Charcoal	100'	Box	266.67 ft ²	\$363.68
MSAL32X100-L48	32" x 100' Aluminum Wire Mesh	Black	100'	Roll	266.67 ft ²	\$402.16
MSAL36X100-L00	36" x 100' Aluminum Wire Mesh	Charcoal	100'	Box	300 ft ²	\$376.14
MSAL36X100-L48	36" x 100' Aluminum Wire Mesh	Black	100'	Box	300 ft ²	\$395.86
MSAL36X100-S01	36" x 100' Aluminum Wire Mesh	Bright	100'	Box	300 ft ²	\$575.12
MSAL48X100-L00	48" x 100' Aluminum Wire Mesh	Charcoal	100'	Box	400 ft ²	\$770.64

SPLINE



WPTF187X250



Foam Spline

Part #	Description	Color	Length	UOM	QTY	List Price
SPFRD130-BX-L	Foam Spline	Black	8,000'	Box	8,000'	\$369.60
SPFRD135-BX-L	.135" Diameter Foam Spline	Black	8,000'	Box	8,000'	\$564.48
SPFRD140-BX-L	Foam Spline	Black	8,000'	Box	8,000'	\$556.80
SPFRD175-BX-L	.175" Diameter Foam Spline	Black	5,000'	Box	5,000'	\$483.00
SPFRD175-BX-L	.150" Diameter Foam Spline	Black	8,000'	Box	8,000'	\$491.04
WPTF187X250	Woolpile Foam, T-Slot	Natural	1,000'	Box	1,000'	\$1012.00

SPRINGS



SG10497



SG412

Part #	Description	UOM	QTY	List Price
SG10497	Spring & Dog Assembly	Box	5,000/pcs	\$3,082.80
SG412	Plunger Spring	Bag	10,000/bag	\$546.00

STRIKES

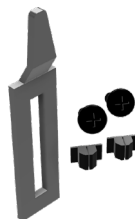

HB-1115-7

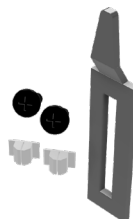

HB-1115-3

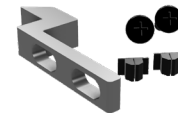

HB-1115-9

Part #	Description	UOM	QTY	List Price
HB-1115-7	Standard Strike Bag	Box	100/box	\$200.00
HB-1115-3	Standard Strike Bag	Box	100/box	\$200.00
HB-1115-9	Standard Strike Bag	Box	100/box	\$400.00

WOOLPILE

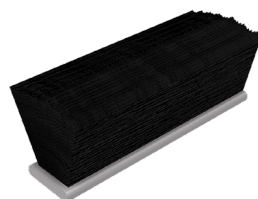

WP3XX187X380-F

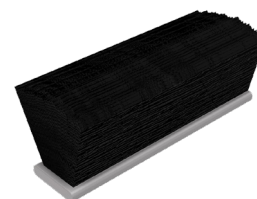

WP7XX187X500-F

Part #	Description	Color	Length	UOM	QTY	List Price
WP3XX187X380-F	.380" High Pile	Standard	4,000'	Box	4,000'	\$1,680.00
WP7XX187X500-F	.500" High Woolpile	Standard	1,500'	Roll	1,500'	\$1,260.00

SMOOTH TRIM COIL



CoilRite
By RITESCREEN



TRIM COIL

24 inch X 50 feet

60.96 CM X 15.24 M

PROFESSIONAL GRADE
ALUMINUM TRIM COIL

Standard White

AS16X24X50C01B

Part #	Description	Color	Length	UOM	List Price
AS16X24X50C01B	24" X 50' Trim Coil	White	50'	Box	\$560.00



RITESCREEEN

4314 Route 209

Elizabethville, PA 17023

1-800-949-4174

www.RITESCREEEN.com

insidesales@ritescreen.com