



# RITESCREEN

- **Window Screens**
- **Patio Door Screens**
- **Components**



## 2025

# Product Catalog



# YOUR TOTAL SCREEN SOLUTIONS



# TABLE OF CONTENTS

Multiplier Sheet	2
Total Screen Solutions	3
Our Process	4
Plant Locations	5
Color Options	6
Screen Mesh Options	7

GENEXT SCREENS	
SH1	10
SH2	11
DH1	12
DH2	13
DH3	14
DH4	15
DH5	16
DH6	17
DH7	18
DH8	19
SL1	20
SL2	21
SL4	22
SL5	23
SL6	24
SL7	25
FS1	26
FS2	27
CA1	28
CA2	29
CA3	30
CA4	31
CA5	32
WK0	33
WK1	34
WK2	35
RS-505223	36
RS-505224	37

ROLL FORMED SCREENS	
RFSH1	40
RFSH2	41
RFSH3	42
RFSH4	43
RFSH5	44
RFSH6	45
RFSH7	46
RFSH8	47
RFSH9	48
RFSH10	49
RFSH11	50
RFSH12	51
RFDH1	52
RFDH2	53
RFDH3	54
RFDH4	55
RFDH5	56
RFDH6	57
RFDH7	58
RFSL1	59
RFSL2	60
RFSL3	61
RFFS1	62
RFFS2	63
RFCA1	64
RFCA2	65
RFCA3	66
FlexScreen	67

PATIO DOOR SCREENS	
121S	70
199EXT	71
170EXT	72
160EXT	73
144EXT	74
MOOSE	75
121SMFIT	76
140SMFIT	77
MOOSEMFIT	78
Aluminum Patio Door Accessories	79
Single Swing Door	80
Double Swing Door	81

KNOCK-DOWN PATIO DOOR KITS	
Ultimate Multi-Fit Knock-Down Patio Door Kit	84
144EXT Knock-Down Kit	85
Customizable Distributor Knock-Down Kit	86
Screen Replacement Kits	87

COMPONENTS	
Bug Strips, Caps, Clips, Crossbars	90
Corners	91
Handles, Latches	92
Leaf Springs, Pins, Plungers, Pull Tabs, Rivets	93
Rollers, Screen Frames	94
Screen Frames Cont.	95
Screen Mesh	96
Screen Mesh Cont.	97
Screen Mesh Cont.	98
Available Mesh Types	99
Spline, Springs	100
Strikes, Woolpile	101
Smooth Trim Coil	102

## Multiplier Sheet

Company Name	
Sold To Number	
Effective Date	
Name	
Address	
Phone	
Email	

RiteScreen Sales Director Approval		Customer Approval	
Name		Name	
Signature		Signature	
Date		Date	

Window Screens							
Extruded Screens				Roll-Formed Screens			
Series	Screen Multiplier	Option Multiplier	Color Multiplier	Series	Screen Multiplier	Option Multiplier	Color Multiplier
SH1				RFSH1			
SH2				RFSH2			
DH1				RFSH3			
DH2				RFSH4			
DH3				RFSH5			
DH4				RFSH6			
DH5				RFSH7			
DH6				RFSH8			
DH7				RFSH9			
DH8				RFSH10			
SL1				RHSF11			
SL2				RFSH12			
SL4				RFDH1			
SL5				RFDH2			
SL6				RFDH3			
FS1				RFDH4			
FS2				RFDH5			
CA1				RFDH6			
CA2				RFDH7			
CA3				RFSL1			
CA4				RFSL2			
CA5				RFSL3			
WK1/WK2				RFFS1			
RS-505223				RFFS2			
RS-505224				RFCA1			
				RFCA2			
				RFCA3			
				FlexScreen			

Patio Door Screens				
Series	Door Multiplier	Roller Multiplier	Option Multiplier	Color Multiplier
12IS				
199EXT				
170EXT				
160EXT				
144EXT				
MOOSE				
SINGLE SWING				
DOUBLE SWING				

Multi-Fit Patio Door				
12ISMFIT				
140SMFIT				
MOOSEMFIT				

Components	
All	

Packaging		
Type	UI List Price	Multiplier
WS - Plastic Wrapped (1-20)	\$1.60	
WS - Cardboard Wrapped (1-20)	\$23.52	
WS - Shipping Box	\$114.24	
PDS - Plastic Wrapped	\$9.36	
PDS - Cardboard Wrapped	\$30.72	
PDS - Shipping Box	\$134.24	

Color Options	
Colors	List Price
Wood-wrap	\$352.00
Customer Specific Color*	\$10.00
Custom Colors	\$90.00
Post Fabricated Painted Screens	\$261.90

Minimum of 10,000 / per year / per color



# RITESCREEN

## TOTAL SCREEN SOLUTIONS

With our extensive experience and screen manufacturing capabilities, RiteScreen is the company you can trust when you decide to outsource.

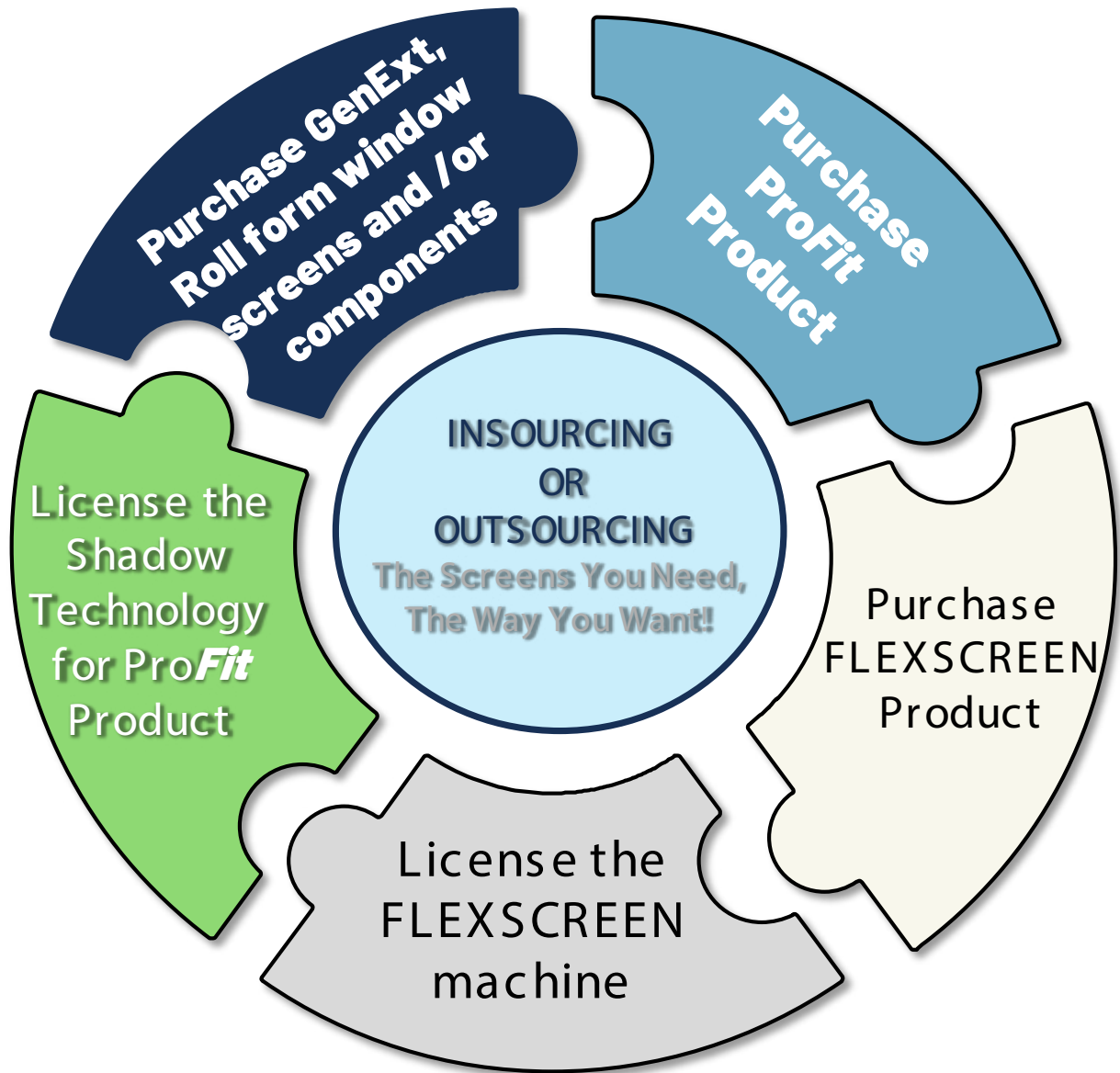

- 100% dedicated to the screen market
- Easiest to Do Business With
- Products for all windows
  - Rigid
  - Flexible
  - Color Solutions

- Assembled products and components
- Simplifies screen customizations
- Flexibility to purchase window screens and door screens on the same PO
- 100% sequenced products
- Shipping all on 1 truck!

# OUR PROCESS

- 1** The RiteScreen Team comes to your facility, performing a comprehensive review of your products, manufacturing processes, and a needs analysis. We offer recommendations on how you can achieve the greatest cost savings.
- 2** Our R&D department goes to work, continuing to collaborate with your team each step of the way to ensure the design provides the best possible value and that your screens will be the perfect fit for the specific products that your produce.
- 3** RiteScreen continues consulting with you on your new processes and products. When you decide to outsource, our team of expert fabricators will get to work producing screens using the designs we developed with your team.
- 4** RiteScreen offers custom-engineered packaging options. Your screens will be delivered from one of our seven strategically located manufacturing facilities to ensure on-time delivery.

## OUR PRODUCTS

### ASSEMBLED WINDOW SCREEN SOLUTIONS

Durable, versatile, and aesthetically pleasing, RiteScreen produces window screens designed for both ease of use and long-term performance.

### ASSEMBLED DOOR SCREEN SOLUTIONS

Roll-formed steel or aluminum and extruded aluminum door screens that feature superior performance and high-quality weatherstripping.

### SCREEN COMPONENTS

Our full line of frames, corners and hardware for both window screens and door screens helps RiteScreen provide a total screen solution to our customers.

### ENGINEERED SOLUTIONS

Our engineers lead the industry with innovative solutions to any screening need, with technology to give any manufacturer the competitive edge.



With over 75 years of experience and seven locations across the country, you can trust RiteScreen to meet all of your screening needs.

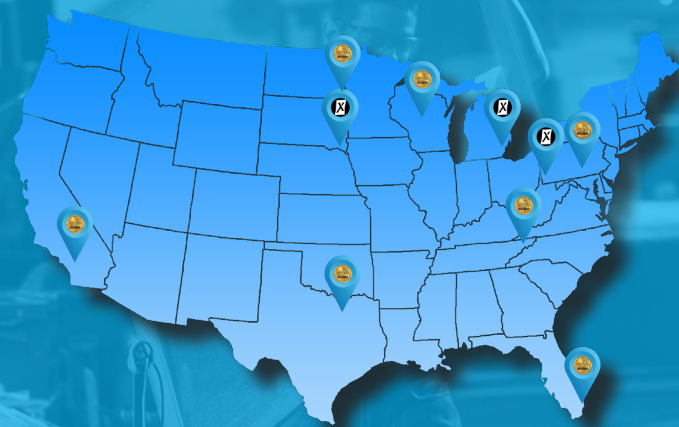

**CONTACT US:**  
**(800) 949-4174**  
**RITESCREEN.COM**  
**INSIDESALES@RITESCREEN.COM**



# RITESCREEN

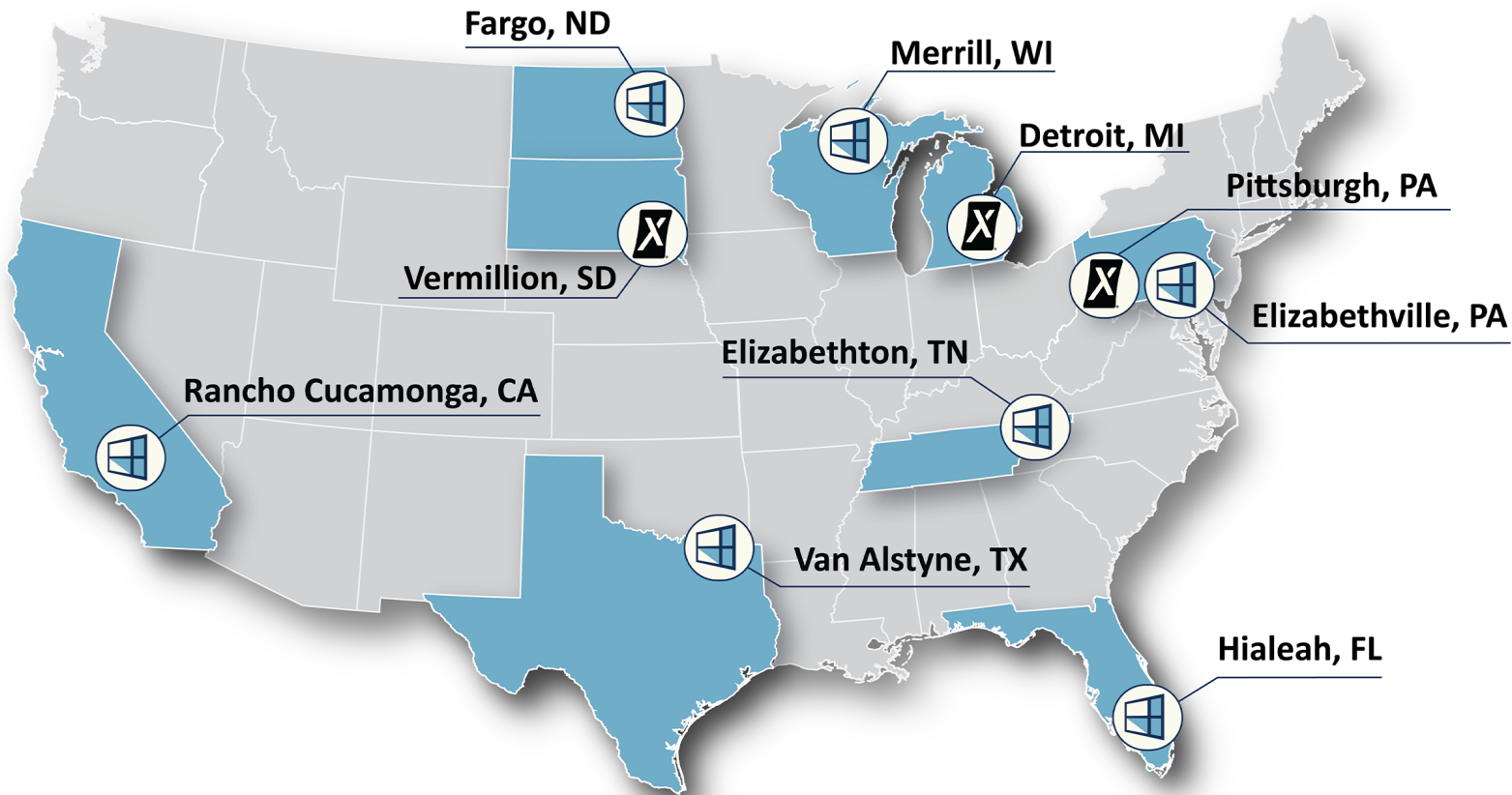

## PLANT LOCATIONS

**Hialeah, FL (RiteScreen Corporate)**

**Elizabethville, PA**

**Van Alstyne, TX**

**Fargo, ND**

**Merrill, WI**

**Elizabethton, TN**

**Rancho Cucamonga, CA**

**Pittsburgh, PA (FlexScreen Corporate)**

**Detroit, MI (FlexScreen)**

**Vermillion, SD (FlexScreen)**

## COLOR SELECTION

**Standard Colors:** Each of the screens in this catalog is available in RiteScreen's Standard Colors for no additional cost.

### Standard Colors:

XXX in part numbers are  
place holders for Color Code



**Additional Colors:** Additional colors are available for customers with specific color needs for an upcharge.

## PACKAGING OPTIONS

RiteScreen offers the following packaging options. Please contact sales director for pricing and specific details on Patio Door Screen packaging.

### PLASTIC WRAPPED



Window Screen (1-20) - \$1.60  
Patio Door Screen - \$9.36  
(Shipping box not included in price, see below)

### CARDBOARD WRAPPED



Window Screen (1-20) - \$23.52  
Patio Door Screen - \$30.72  
(Shipping box not included in price, see below)

### SHIPPING BOX



Window Screen - \$114.25  
Patio Door Screen - \$134.24



### BetterVue®

BetterVue® insect screening with Water Shed Technology™ preserves optical clarity by shedding water and resisting dirt and grime for a sharp, more brilliant outward view.

**Add 0.0640 UI**



### UltraVue®

If you're looking for an insect screening that will block the pests but not the view, then UltraVue® excellent visibility (eVis) screening is for you.

**Add 0.1200 UI**



### Tuff-Screen®

Looking for a reliable insect screen that's built to last? Tuff-Screen No-See-Ums is made from durable mesh and keeps small insects out.

**Add 0.2300 UI**



### Solar Screen

Learn more about SunScreen, the original woven solar screen fabric. SunScreen stops insects and blocks up to 70% of the sun's heat.

**Add 0.3440 UI**

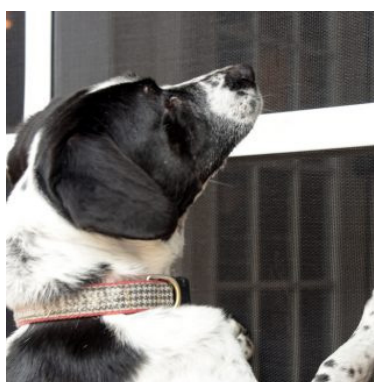

### PetScreen®

Looking for an insect screen that will keep bugs out but withstand the wear and tear from your dog or cat? PetScreen is the perfect choice for you!

**Add 0.2460 UI**

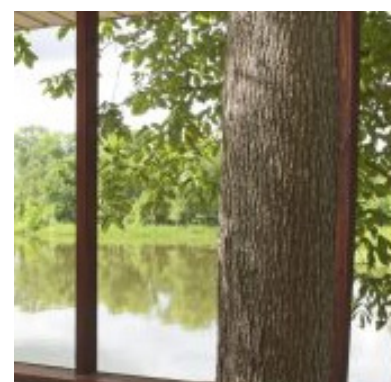

### Standard Aluminum

Looking for a reliable insect screen that sets the standard for quality? Our standard aluminum insect screen provides insect protection along with increased visibility.

**Add 0.1120 UI**

Insect screens will not stop a child from falling out of a window. Keep child away from open/unlocked window.





# GENEXT WINDOW SCREENS

A woman is sitting on a bed, looking out a window. The window has a white GenExt window screen. The view outside the window is a bright, sunny day with a clear blue sky and a lush green landscape. The woman is wearing a light-colored, long-sleeved button-down shirt and blue jeans. The bed has a dark wood headboard and a beige, textured pillow. The overall scene is bright and airy, suggesting a comfortable and durable living environment.

**Our GenExt window screens  
are durable and guaranteed to last!**

# SH1 - Single Hung Top Springs

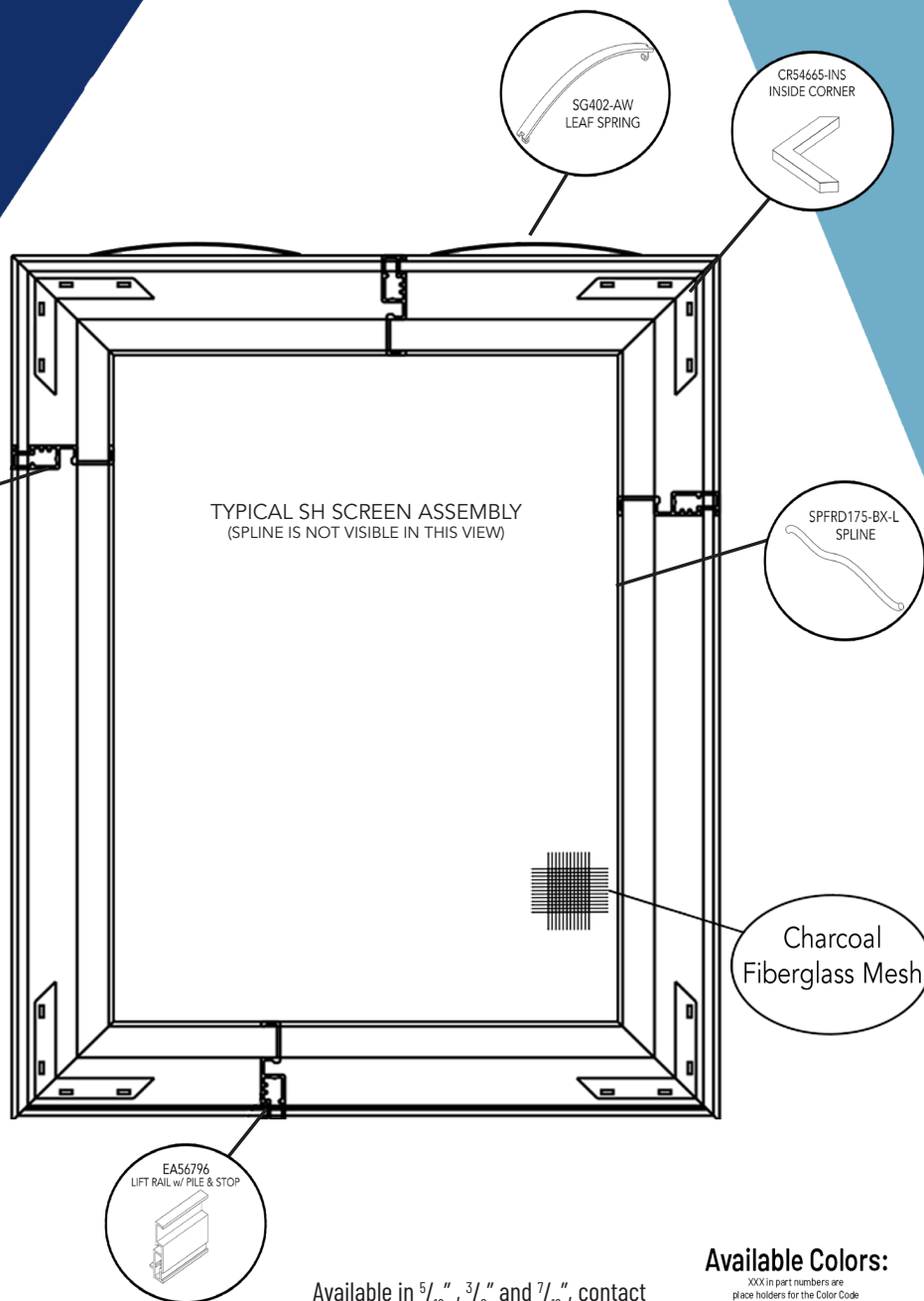
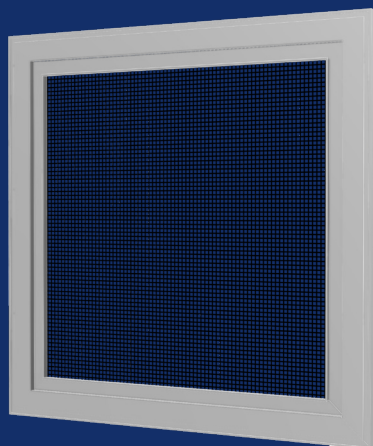

Available in  $\frac{5}{16}$ " ,  $\frac{3}{8}$ " and  $\frac{7}{16}$ " , contact RiteScreen for details.

### Available Colors:

XXX in part numbers are place holders for the Color Code

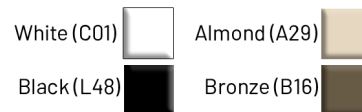

Series #	Fully Assembled Screen	Size	UOM	List Price
SH1	Minimum Price	0" to 49" UI	United Inch	\$43.30
SH1	U.I. Price	50" UI and Above	United Inch	\$0.8838

Part #	Description	Color	Length	UOM	QTY	List Price
EA56801-204-XXX	Lift Rail w/Pile	See Chart	17'	Box	20/pcs	\$1,542.49
EA56796-204-XXX	Lift Rail w/Pile and Stop	See Chart	17'	Box	20/pcs	\$1,566.73
XCR54665-INS**	Inside Corner	Mill		Box	100/pcs	\$112.30
XSG402-AW**	Leaf Spring	Mill		Box	100/pcs	\$84.66
MSFG36X100-L00	36" x 100' Char Fiber Mesh	Charcoal	100'	Roll	400 ft <sup>2</sup>	\$184.80
SPFRD175-BX-L	.175" Diameter Foam Spline	Black	5,000'	Box	5,000'	\$413.60

\*\*Available in bulk quantities

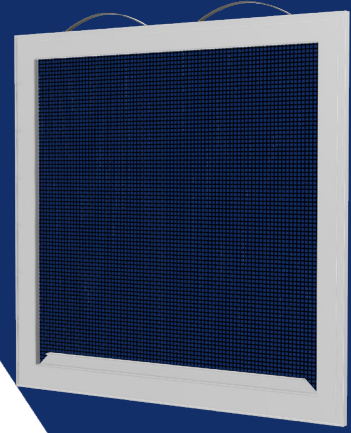
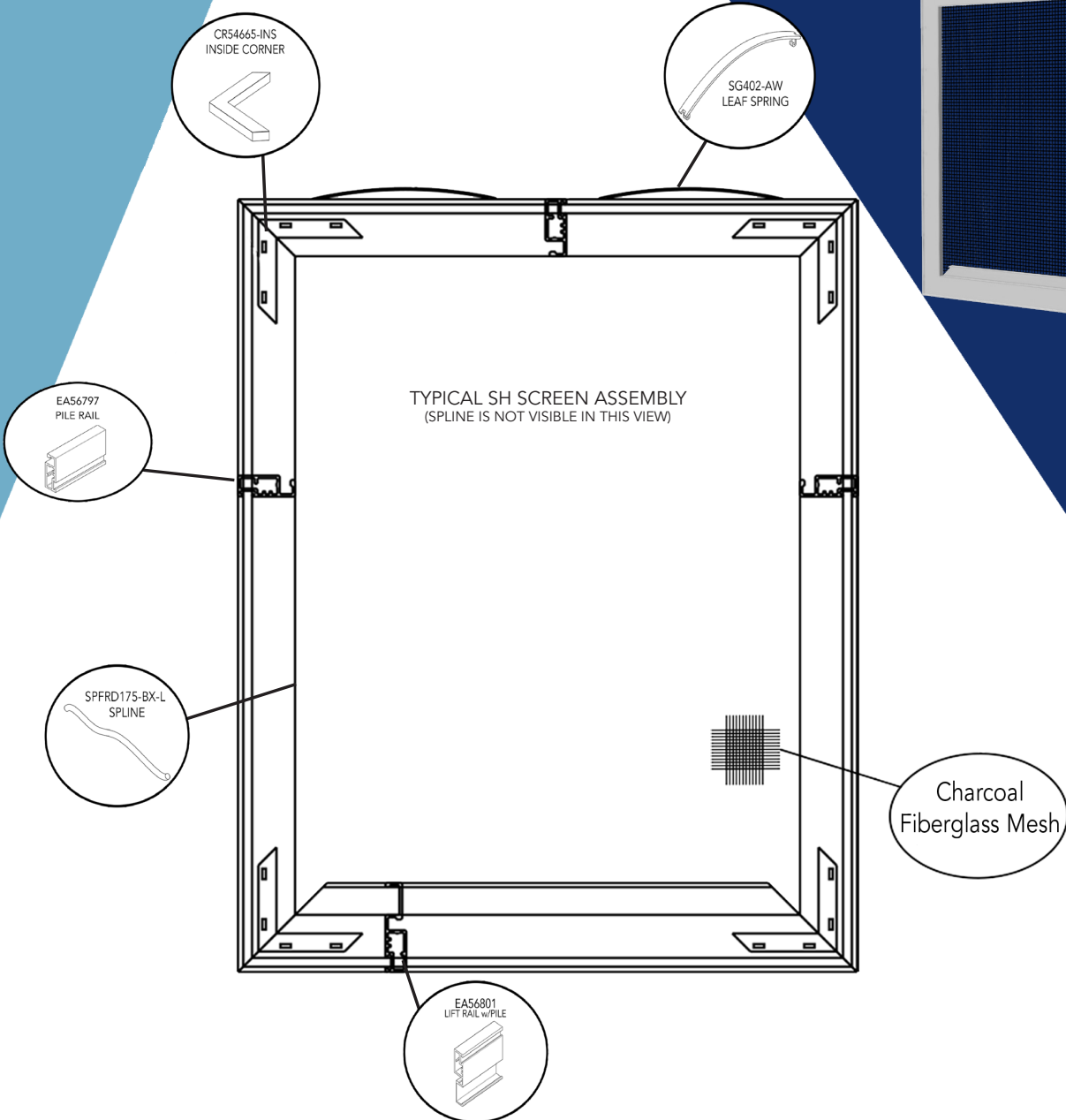

### Available Colors:

XXX in part numbers are place holders for the Color Code

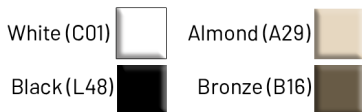

Available in  $\frac{5}{16}$ " ,  $\frac{3}{8}$ " and  $\frac{7}{16}$ " contact RiteScreen for details.

Series #	Fully Assembled Screen	Size	UOM	List Price
SH2	Minimum Price	0" to 49" UI	United Inch	\$38.86
SH2	U.I. Price	50" UI and Above	United Inch	\$0.7930

Part #	Description	Color	Length	UOM	QTY	List Price
EA56801-204-XXX	Lift Rail w/Pile	See Chart	12.5'	Box	20/pcs	\$1,542.49
EA56797-204-XXX	Pile Rail	See Chart	17'	Box	20/pcs	\$1,297.28
XCR54665-INS**	Inside Corner	Mill		Box	100/pcs	\$112.30
XSG402-AW**	Leaf Spring	Mill		Box	100/pcs	\$84.66
MSFG36X100-L00	36" x 100' Char Fiber Mesh	Charcoal	100'	Roll	400 ft <sup>2</sup>	\$184.80
SPFRD175-BX-L	.175" Diameter Foam Spline	Black	5,000'	Box	5,000'	\$413.60

\*\* Available in bulk quantities

# DH1 - Double Hung Half Screen

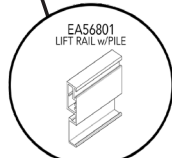
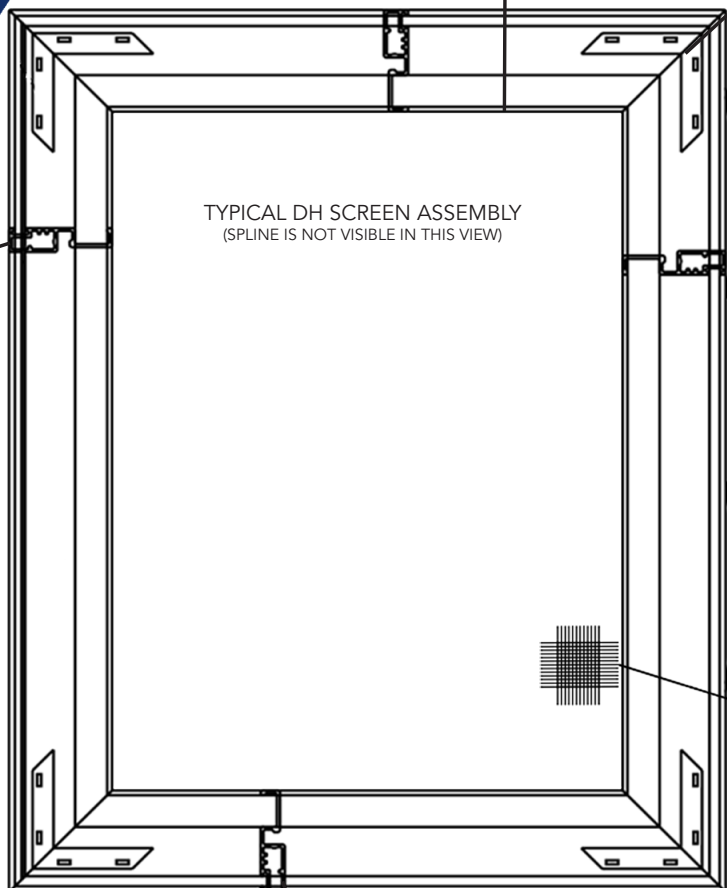
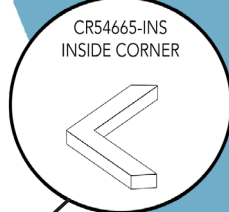
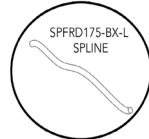
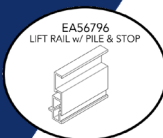
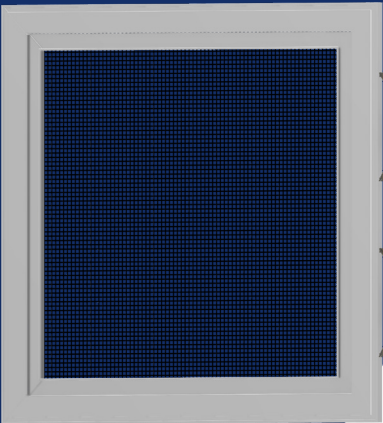

Available in  $\frac{5}{16}$ " ,  $\frac{3}{8}$ " and  $\frac{7}{16}$ " , contact RiteScreen for details.

### Available Colors:

XXX in part numbers are place holders for the Color Code

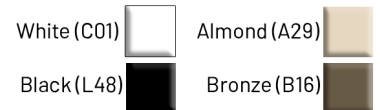

Series #	Fully Assembled Screen	Size	UOM	List Price
DH1	Minimum Price	0" to 49" UI	United Inch	\$41.12
DH1	U.I. Price	50" UI and Above	United Inch	\$0.8390

Part #	Description	Color	Length	UOM	QTY	List Price
EA56801-204-XXX	Lift Rail w/Pile	See Chart	12.5'	Box	20/pcs	\$1,542.49
EA56796-204-XXX	Lift Rail w/Pile and Stop	See Chart	17'	Box	20/pcs	\$1,566.73
XCR54665-INS**	Inside Corner	Mill		Box	100/pcs	\$112.30
XSG402-AW**	Leaf Spring	Mill		Box	100/pcs	\$84.66
MSFG36X100-L00	36" x 100' Char Fiber Mesh	Charcoal	100'	Roll	400 ft <sup>2</sup>	\$184.80
SPFRD175-BX-L	.175" Diameter Foam Spline	Black	5,000'	Box	5,000'	\$413.60

\*\*Available in bulk quantities

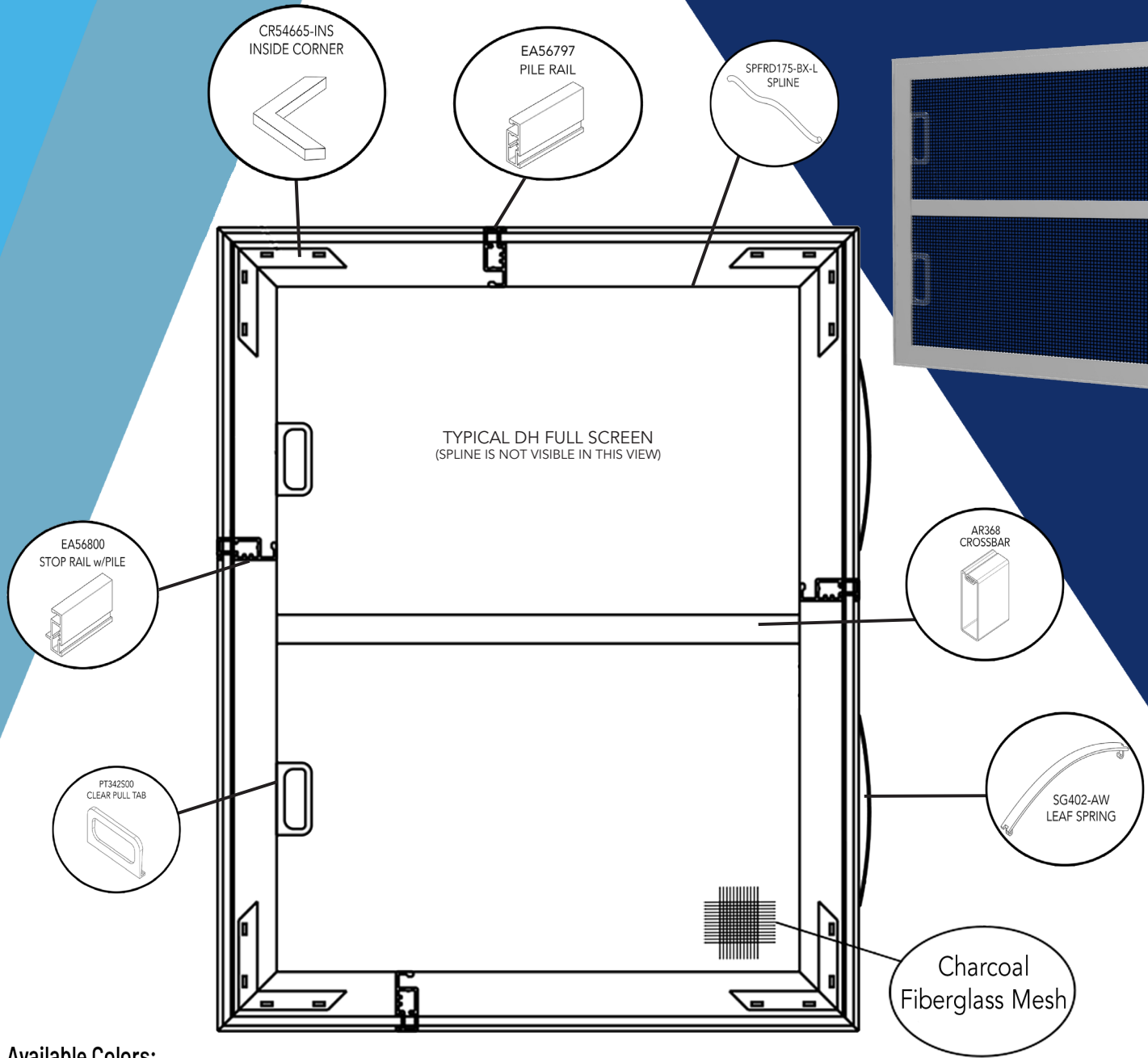

### Available Colors:

XXX in part numbers are place holders for the Color Code

White (C01)		Almond (A29)	
Black (L48)		Bronze (B16)	

Available in  $\frac{5}{16}$ " ,  $\frac{3}{8}$ " and  $\frac{7}{16}$ " , contact RiteScreen for details.

Series #	Fully Assembled Screen	Size	UOM	List Price
DH2	Minimum Price	0" to 49" UI	United Inch	\$35.02
DH2	U.I. Price	50" UI and Above	United Inch	\$0.7146

Part #	Description	Color	Length	UOM	QTY	List Price
EA56797-204-XXX	Pile Rail	See Chart	17'	Box	20/pcs	\$1,297.28
EA56800-204-XXX	Stop Rail w/Pile	See Chart	17'	Box	20/pcs	\$1,463.21
AR368-16-12XXX	Crossbar	See Chart	12.5'	Box	152/pcs	\$1,583.36
XCR54665-INS**	Inside Corner	Mill		Box	100/pcs	\$112.30
XPT342500**	Clear Pull Tab	Clear		Box	100/pcs	\$84.14
XSG402-AW**	Leaf Spring	Mill		Box	100/pcs	\$84.66
MSFG36X100-L00	36" x 100' Char Fiber Mesh	Charcoal	100'	Roll	400 ft <sup>2</sup>	\$184.80
SPFRD175-BX-L	.175" Diameter Foam Spline	Black	5,000'	Box	5,000'	\$413.60

\*\*Available in bulk quantities

# DH3 - Double Hung Half Latching Screen

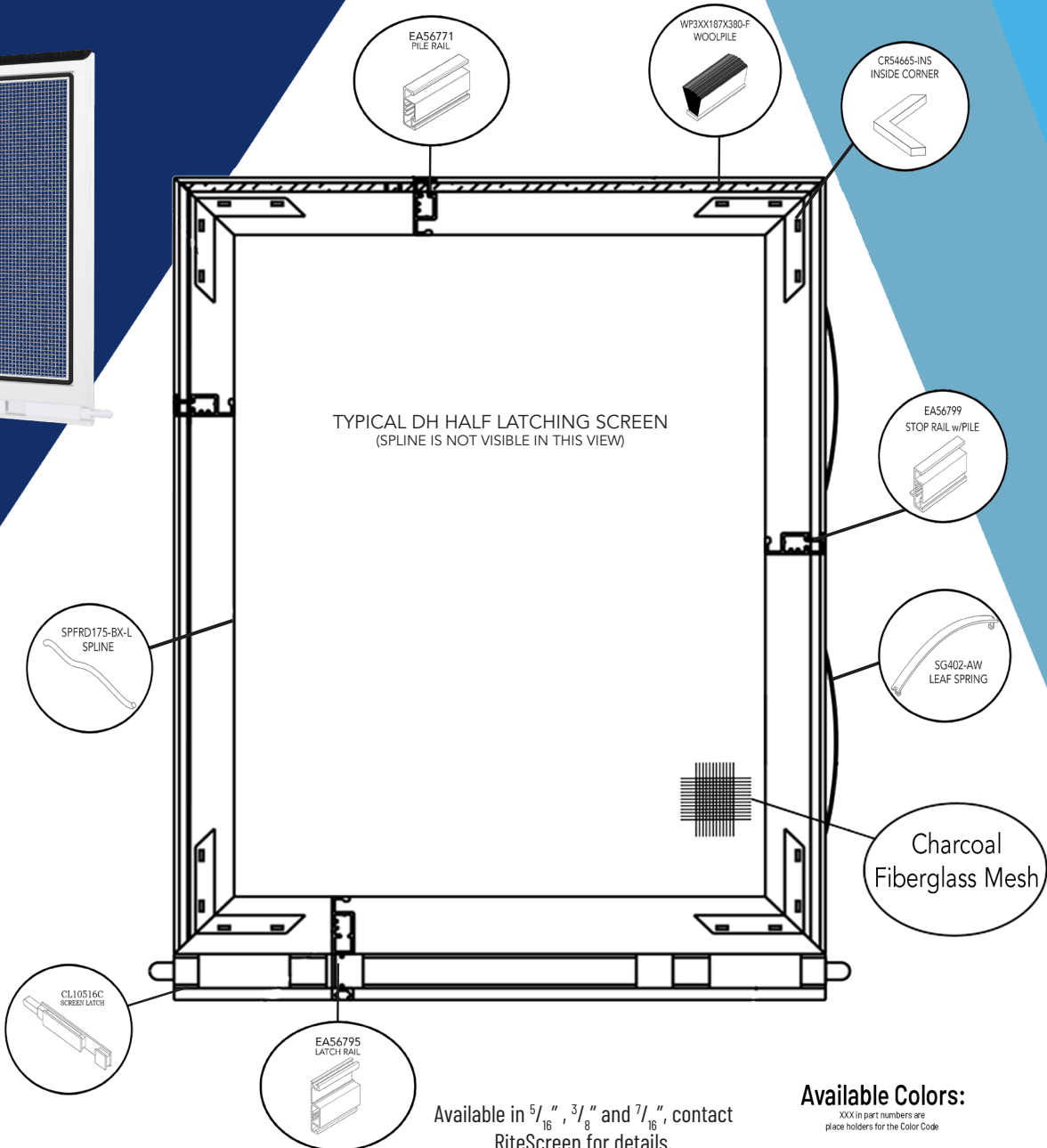

Available in  $\frac{5}{16}$ " ,  $\frac{3}{8}$ " and  $\frac{7}{16}$ " , contact RiteScreen for details.

### Available Colors:

XXX in part numbers are place holders for the Color Code

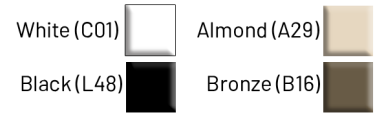

Series #	Fully Assembled Screen	Size	UOM	List Price
DH3	Minimum Price	0" to 49" UI	United Inch	\$48.52
DH3	U.I. Price	50" UI and Above	United Inch	\$0.9904

Part #	Description	Color	Length	UOM	QTY	List Price
EA56771-187-XXX	Pile Rail	See Chart	15.5'	Box	20/pcs	\$1,297.28
EA56799-204-XXX	Stop Rail w/Pile	See Chart	17'	Box	20/pcs	\$1,464.10
EA56795-187-XXX	Latch Rail	See Chart	15.5'	Box	20/pcs	\$1,633.25
XSG10497**	Spring & Dog Assembly (not shown)	Mill		Box	100/pcs	\$127.87
XCL10516C**	Screen Latch	Standard		Box	100/pcs	\$184.90
XCR54665-INS**	Inside Corner	Mill		Box	100/pcs	\$112.30
XSG402-AW**	Leaf Spring	Mill		Box	100/pcs	\$84.66
WP3XX187X380-F	.380" High Pile	Standard	4,000 ft.	Box	4,000 ft.	\$1,152.80
MSFG36X100-L00	36" x 100' Char Fiber Mesh	Charcoal	100'	Roll	400 ft <sup>2</sup>	\$184.80
SPFRD175-BX-L	.175" Diameter Foam Spline	Black	5,000'	Box	5,000'	\$413.60

\*\*Available in bulk quantities

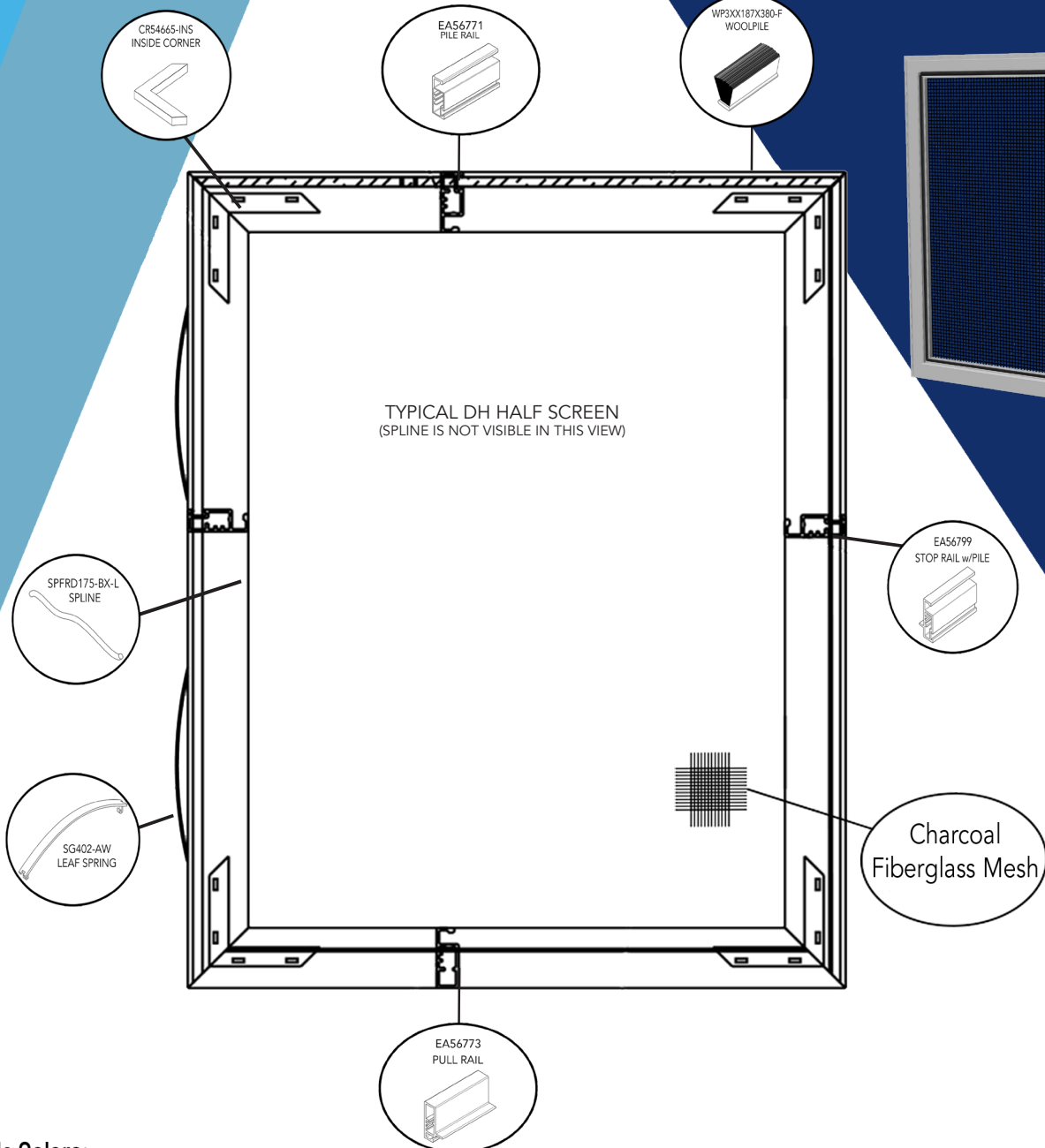

### Available Colors:

XXX in part numbers are place holders for the Color Code

- White (C01) 
- Almond (A29) 
- Black (L48) 

Available in  $\frac{5}{16}$ " ,  $\frac{3}{8}$ " and  $\frac{7}{16}$ " contact RiteScreen for details.

Series #	Fully Assembled Screen	Size	UOM	List Price
DH4	Minimum Price	0" to 49" UI	United Inch	\$37.22
DH4	U.I. Price	50" UI and Above	United Inch	\$0.7598

Part #	Description	Color	Length	UOM	QTY	List Price
EA56771-187-XXX	Pile Rail	See Chart	15.5'	Box	20/pcs	\$1,297.28
EA56799-204-XXX	Stop Rail w/Pile	See Chart	17'	Box	20/pcs	\$1,464.10
EA56773-187-XXX	Pull Rail	See Chart	15.5'	Box	20/pcs	\$1,274.24
XCR54665-INS**	Inside Corner	Mill		Box	100/pcs	\$112.30
XSG402-AW**	Leaf Spring	Mill		Box	100/pcs	\$84.66
WP3XX187X380-F	.380" High Pile	Standard	4,000 ft.	Box	4,000 ft.	\$1,152.80
MSFG36X100-L00	36" x 100' Char Fiber Mesh	Charcoal	100'	Roll	400 ft <sup>2</sup>	\$184.80
SPFRD175-BX-L	.175" Diameter Foam Spline	Black	5,000'	Box	5,000'	\$413.60

\*\*Available in bulk quantities



# DH5 - Double Hung Flanged Full Screen

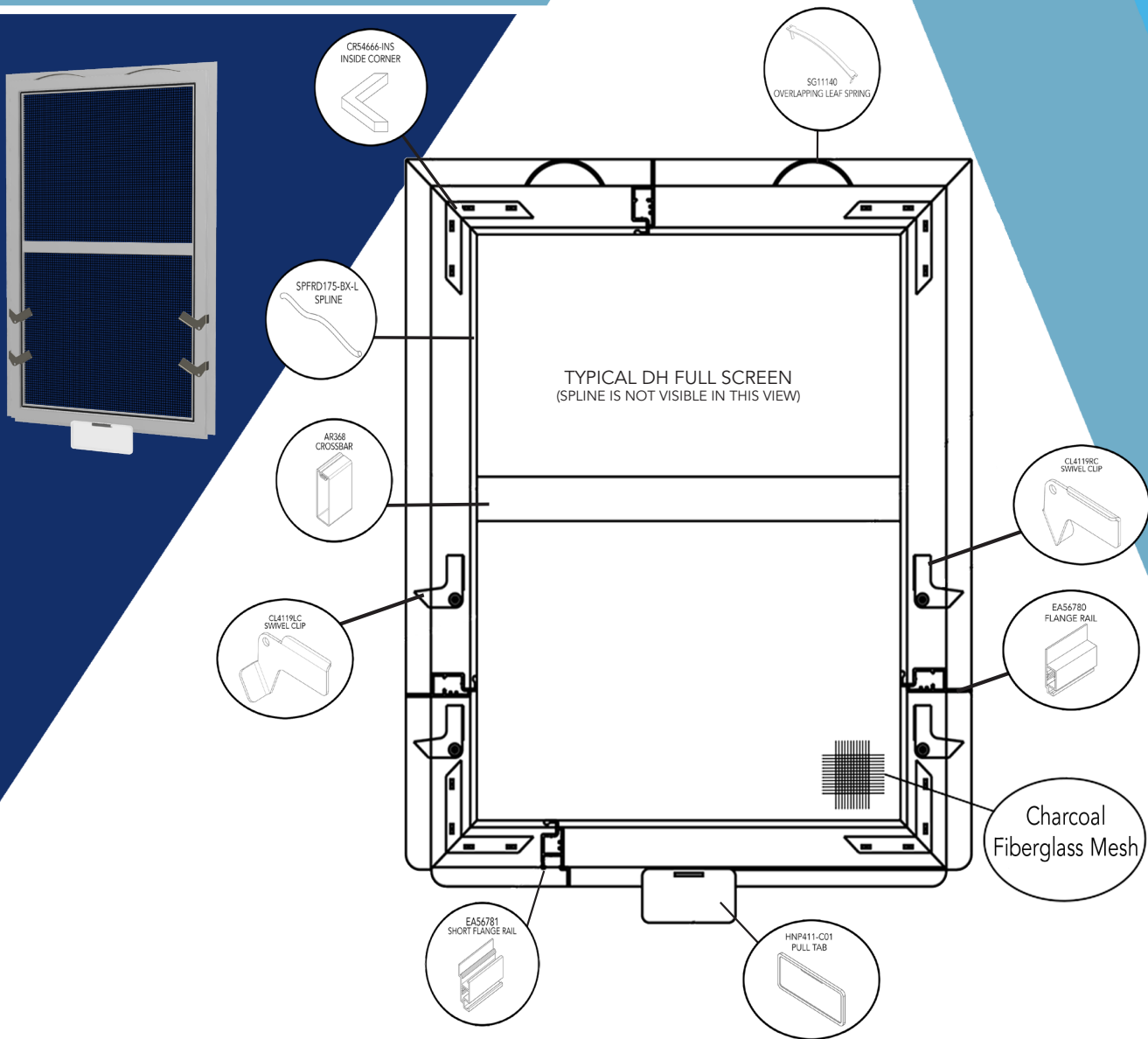

Shown in  $\frac{3}{8}$ "

### AVAILABLE COLORS

XXX in part numbers are place holders for Color Code



Black (L48) White (C01) Bronze (B16)

Series #	Fully Assembled Screen	Size	UOM	List Price
DH5	Minimum Price	0" to 49" UI	United Inch	\$52.18
DH5	U.I. Price	50" UI and Above	United Inch	\$1.0648

Part #	Description	Color	Length	UOM	QTY	List Price
EA56780-229-XXX	Flange Rail	See Chart	19'	Box	20/pcs	\$1,593.07
EA56781-187-XXX	Short Flange Rail	See Chart	15.5'	Box	20/pcs	\$1,365.57
AR368-16-12XXX	Crossbar	See Chart	12.5'	Box	152/pcs	\$1,583.36
XCR54666-INS**	Inside Corner	Mill		Box	100/pcs	\$127.17
XCL4119LC**	Swivel Clip (Left)	White		Box	100/pcs	\$171.52
XCL4119RC**	Swivel Clip (Right)	White		Box	100/pcs	\$171.52
XFS527**	Rivet (Not shown)	Mill		Box	100/pcs	\$73.93
XHNP411-XXX**	Pull Tab	White or Black		Box	100/pcs	\$568.40
XCL12337**	Metal Clip (Pull Tab) (Not shown)	Mill		Box	100/pcs	\$195.52
XSG11140**	Overlapping Leaf Spring	Mill		Box	100/pcs	\$109.92
MSFG36X100-L00	36" x 100' Char Fiber Mesh	Charcoal	100'	Roll	400 ft <sup>2</sup>	\$184.80
SPFRD175-BX-L	.175" Diameter Foam Spline	Black	5,000'	Box	5,000'	\$413.60

\*\*Available in bulk quantities

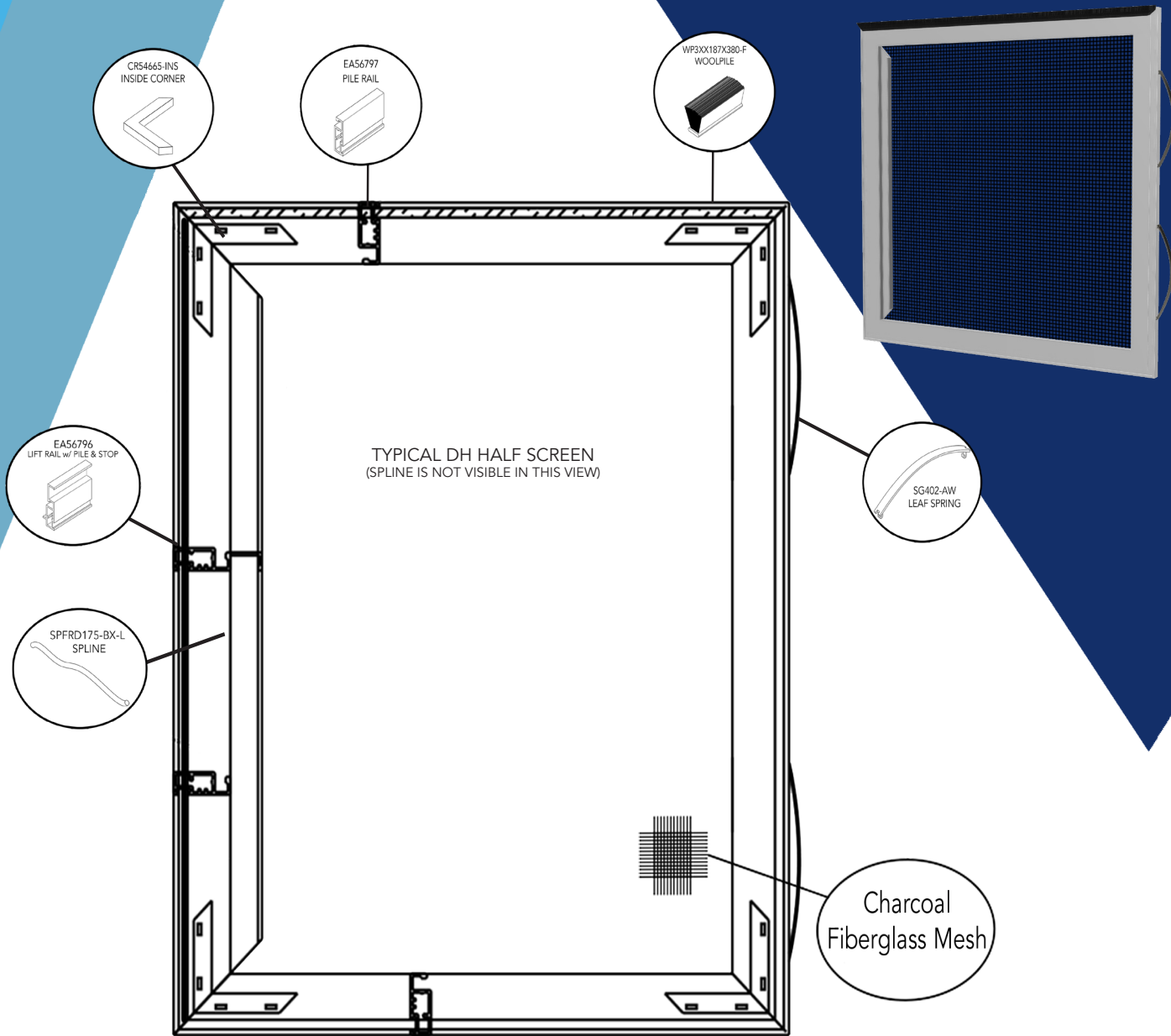

### Available Colors:

XXX in part numbers are  
place holders for the Color Code

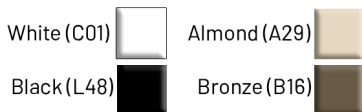

Available in  $\frac{5}{16}$ " ,  $\frac{3}{8}$ " and  $\frac{7}{16}$ " , contact  
RiteScreen for details.

Series #	Fully Assembled Screen	Size	UOM	List Price
DH6	Minimum Price	0" to 49" UI	United Inch	\$39.66
DH6	U.I. Price	50" UI and Above	United Inch	\$0.8094

Part #	Description	Color	Length	UOM	QTY	List Price
EA56797-204-XXX	Pile Rail	See Chart	17'	Box	20/pcs	\$1,297.28
EA56796-204-XXX	Lift Rail w/Pile and Stop	See Chart	17'	Box	20/pcs	\$1,566.73
XCR54665-INS**	Inside Corner	Mill		Box	100/pcs	\$112.30
XSG402-AW**	Leaf Spring	Mill		Box	100/pcs	\$84.66
WP3XX187X380-F	.380" High Pile	Standard	4,000'	Box	4,000'	\$1,152.80
MSFG36X100-L00	36" x 100' Char Fiber Mesh	Charcoal	100'	Roll	400 ft <sup>2</sup>	\$184.80
SPFRD175-BX-L	.175" Diameter Foam Spline	Black	5,000'	Box	5,000'	\$413.60

\*\*Available in bulk quantities

# DH7 - Double Hung Half Screen

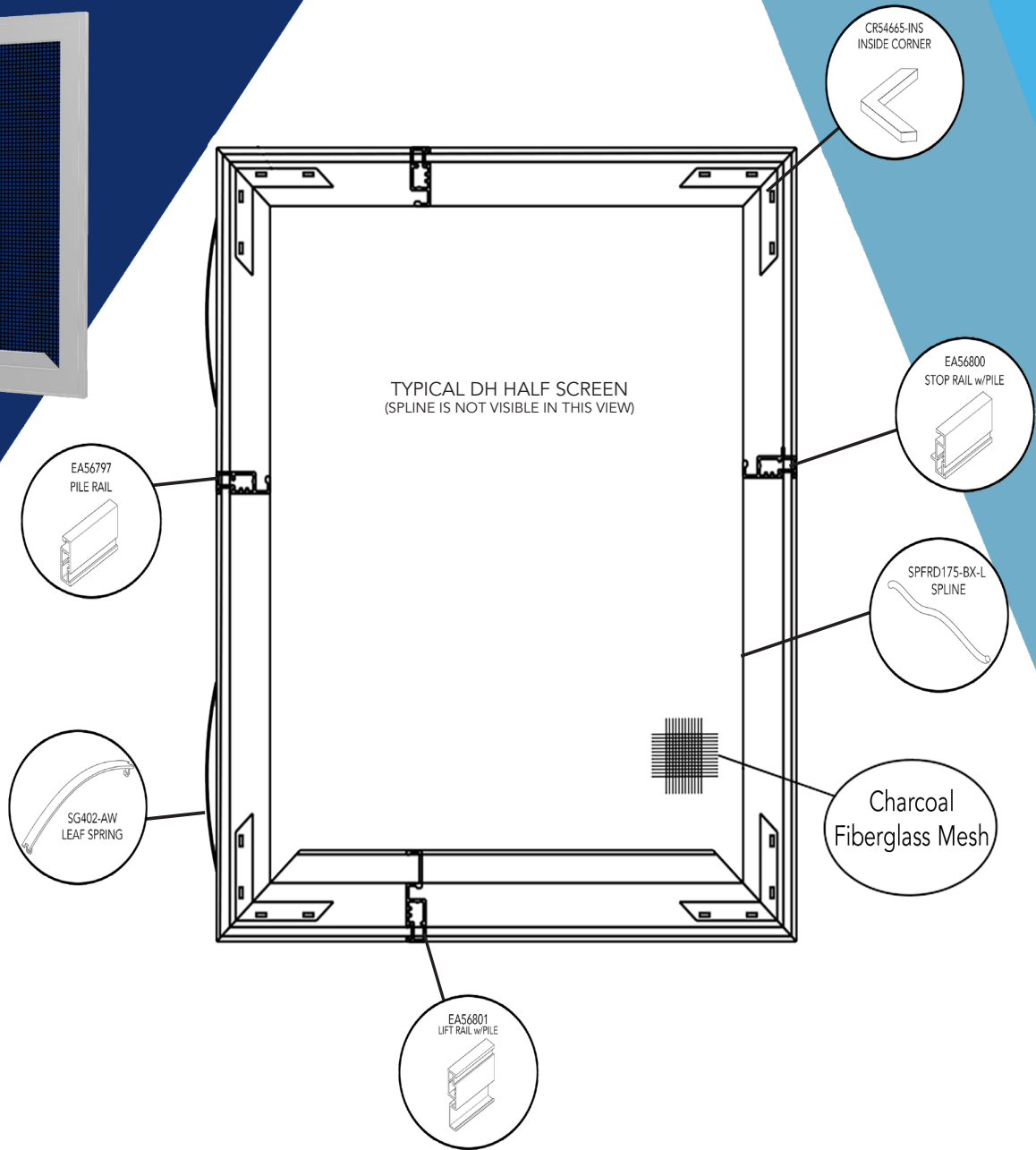
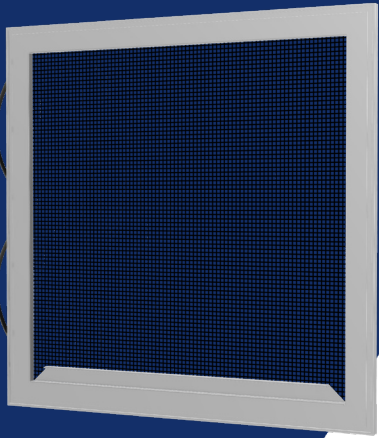

Available in  $\frac{5}{16}$ " ,  $\frac{3}{8}$ " and  $\frac{7}{16}$ " , contact RiteScreen for details.

### Available Colors:

XXX in part numbers are place holders for the Color Code

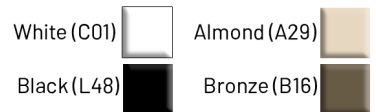

Series #	Fully Assembled Screen	Size	UOM	List Price
DH7	Minimum Price	0" to 49" UI	United Inch	\$39.76
DH7	U.I. Price	50" UI and Above	United Inch	\$0.8116

Part #	Description	Color	Length	UOM	QTY	List Price
EA56797-204-XXX	Pile Rail	See Chart	17'	Box	20/pcs	\$1,297.28
EA56801-204-XXX	Lift Rail w/Pile	See Chart	17'	Box	20/pcs	\$1,542.49
EA56800-204-XXX	Stop Rail w/Pile	See Chart	17'	Box	20/pcs	\$1,463.21
XCR54665-INS**	Inside Corner	Mill		Box	100/pcs	\$112.30
XSG402-AW**	Leaf Spring	Mill		Box	100/pcs	\$84.66
SPFRD175-BX-L	.175" Diameter Foam Spline	Black	5,000'	Box	5,000'	\$413.60
MSFG36X100-L00	36" x 100' Char Fiber Mesh	Charcoal	100'	Roll	400 ft <sup>2</sup>	\$184.80

\*\*Available in bulk quantities

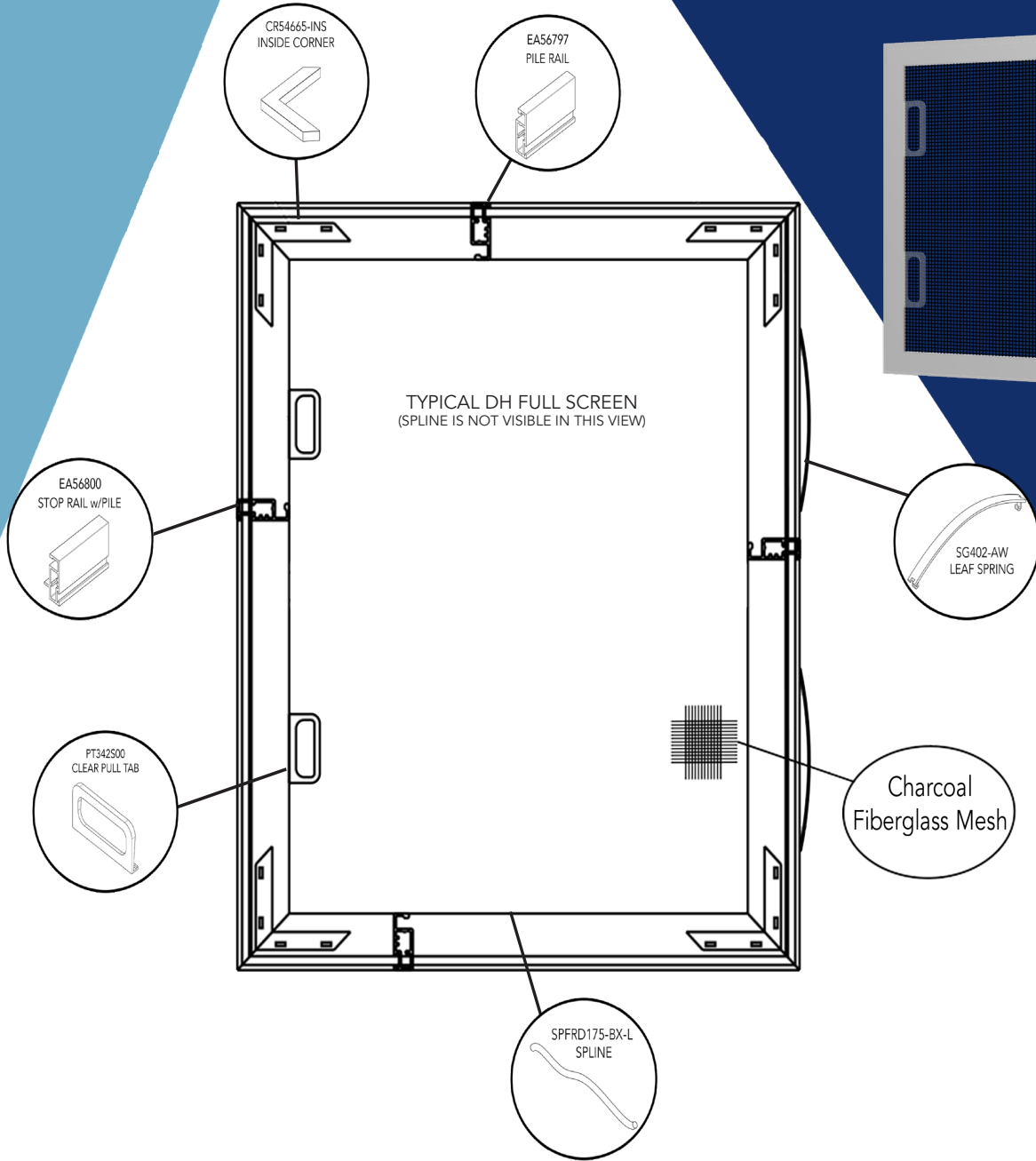

### Available Colors:

XXX in part numbers are place holders for the Color Code

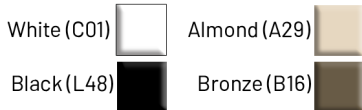

Available in  $\frac{5}{16}$ " ,  $\frac{3}{8}$ " and  $\frac{7}{16}$ " , contact RiteScreen for details.

Series #	Fully Assembled Screen	Size	UOM	List Price
DH8	Minimum Price	0" to 49" UI	United Inch	\$35.02
DH8	U.I. Price	50" UI and Above	United Inch	\$0.7146

Part #	Description	Color	Length	UOM	QTY	List Price
EA56797-204-XXX	Pile Rail	See Chart	17'	Box	20/pcs	\$1,297.28
EA56800-204-XXX	Stop Rail w/Pile	See Chart	17'	Box	20/pcs	\$1,463.21
XCR54665-INS**	Inside Corner	Mill		Box	100/pcs	\$112.30
XSG402-AW**	Leaf Spring	Mill		Box	100/pcs	\$84.66
XPT342S00**	Clear Pull Tab	Clear		Box	100/pcs	\$84.14
MSFG36X100-L00	36" x 100' Char Fiber Mesh	Charcoal	100'	Roll	400 ft <sup>2</sup>	\$184.80
SPFRD175-BX-L	.175" Diameter Foam Spline	Black	5,000'	Box	5,000'	\$413.60

\*\* Available in bulk quantities

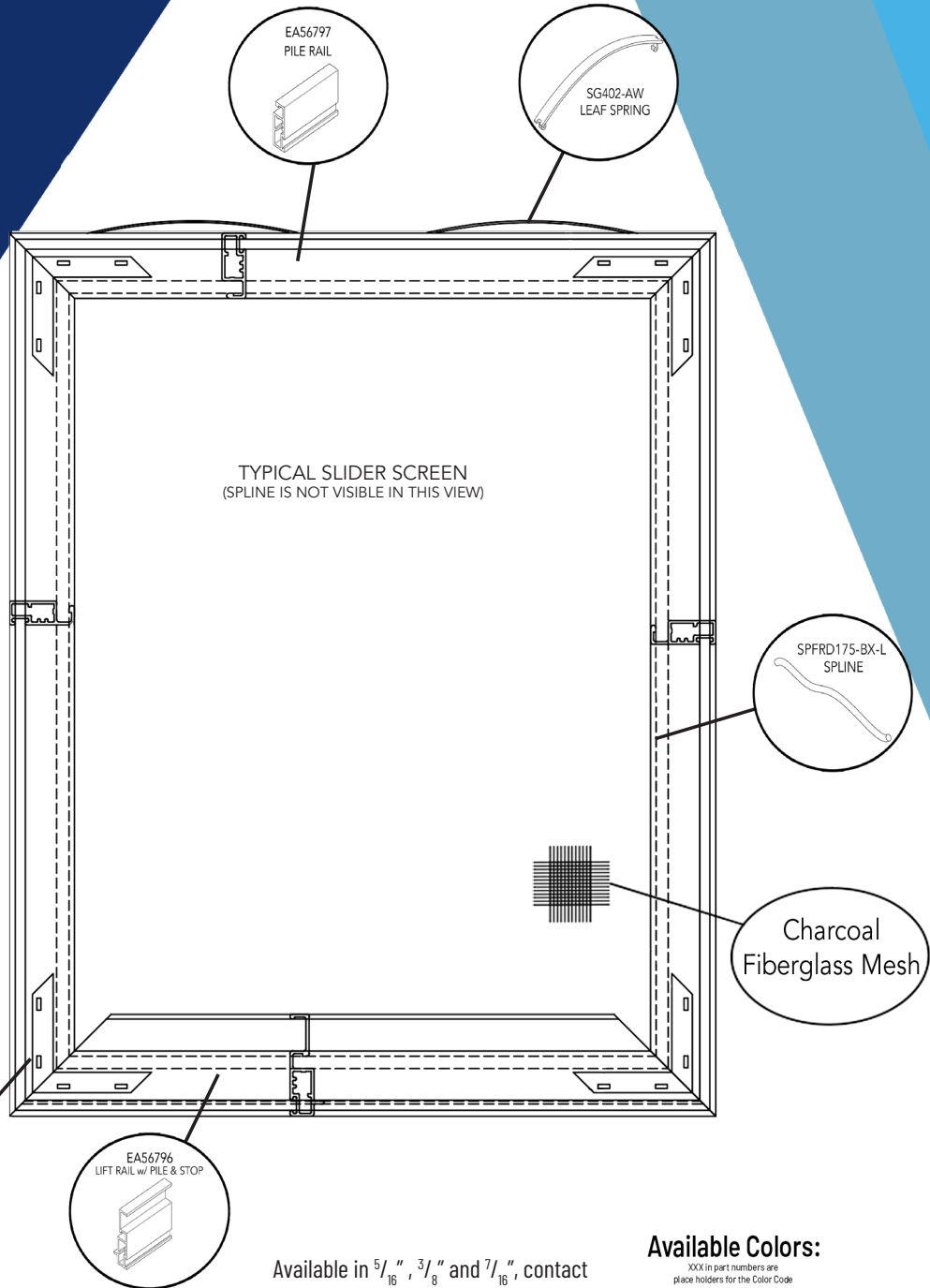
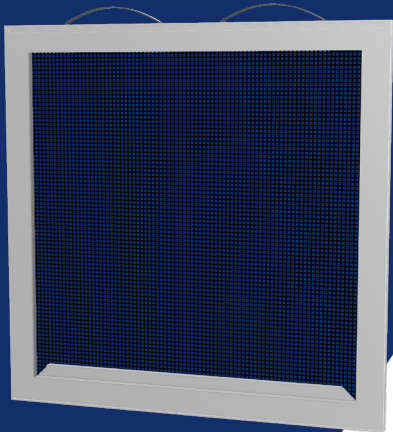

Available in  $\frac{5}{16}$ " ,  $\frac{3}{8}$ " and  $\frac{7}{16}$ " , contact RiteScreen for details.

### Available Colors:

XXX in part numbers are place holders for the Color Code

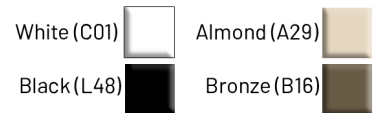

Series #	Fully Assembled Screen	Size	UOM	List Price
SL1	Minimum Price	0" to 49" UI	United Inch	\$37.08
SL1	U.I. Price	50" UI and Above	United Inch	\$0.7566

Part #	Description	Color	Length	UOM	QTY	List Price
EA56797-204-XXX	Pile Rail	See Chart	17'	Box	20/pcs	\$1,297.28
EA56796-204-XXX	Lift Rail w/Pile and Stop	See Chart	17'	Box	20/pcs	\$1,566.73
XCR54665-INS**	Inside Corner	Mill		Box	100/pcs	\$112.30
XSG402-AW**	Leaf Spring	Mill		Box	100/pcs	\$84.66
MSFG36X100-L00	36" x 100' Char Fiber Mesh	Charcoal	100'	Roll	400 ft <sup>2</sup>	\$184.80
SPFRD175-BX-L	.175" Diameter Foam Spline	Black	5,000'	Box	5,000'	\$413.60

\*\*Available in bulk quantities

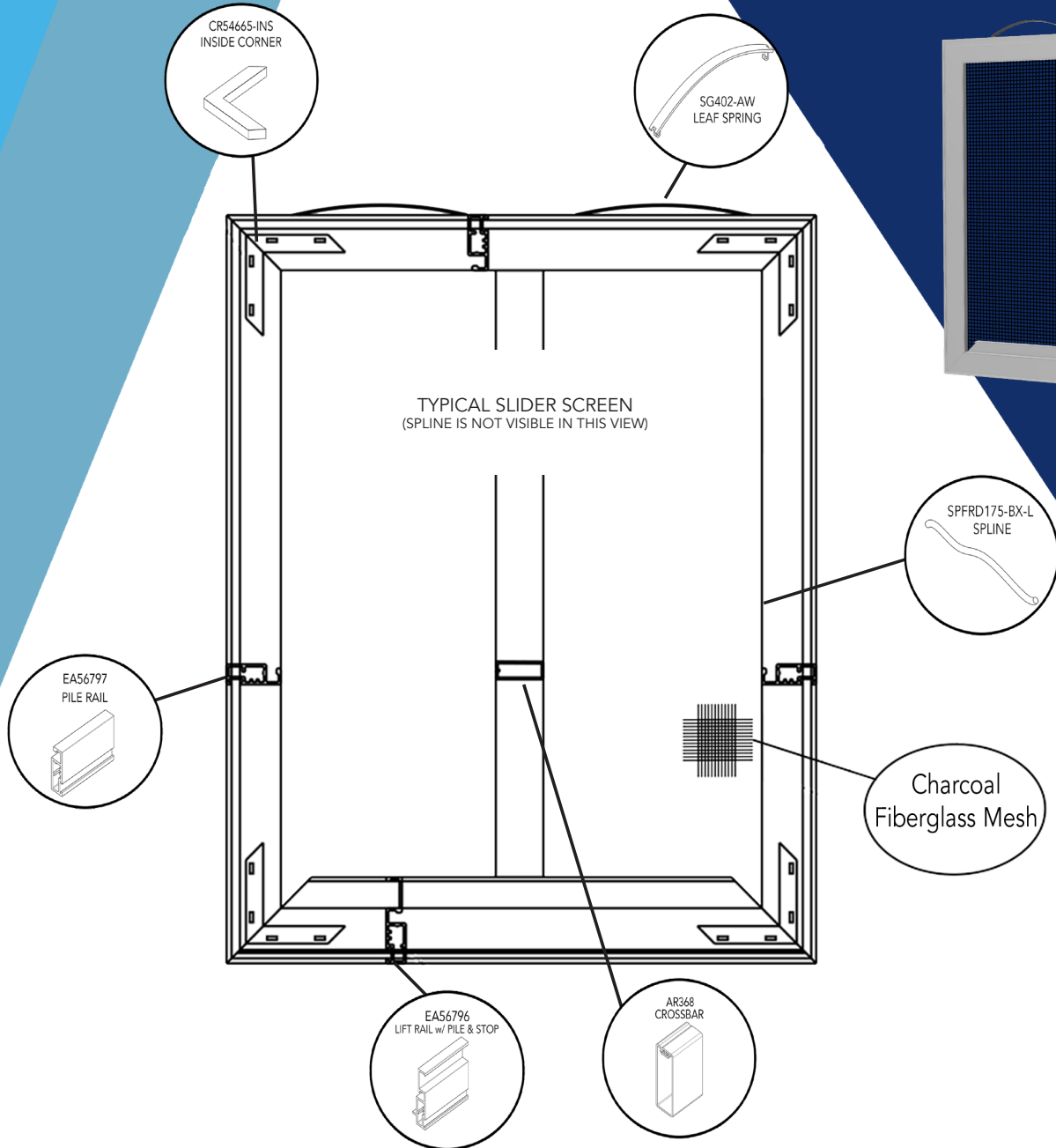

### Available Colors:

XXX in part numbers are place holders for the Color Code

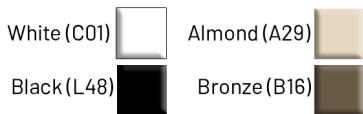

Available in  $\frac{5}{16}$ " ,  $\frac{3}{8}$ " and  $\frac{7}{16}$ " , contact RiteScreen for details.

Series #	Fully Assembled Screen	Size	UOM	List Price
SL2	Minimum Price	0" to 49" UI	United Inch	\$38.10
SL2	U.I. Price	50" UI and Above	United Inch	\$0.7776

Part #	Description	Color	Length	UOM	QTY	List Price
EA56797-204-XXX	Pile Rail	See Chart	17'	Box	20/pcs	\$1,297.28
EA56776-229-XXX	Edge Stop Rail	See Chart	19'	Box	20/pcs	\$1,453.34
AR368-16-12XXX	Crossbar	See Chart	12.5'	Box	152/pcs	\$1,583.36
XCR54665-INS**	Inside Corner	Mill		Box	100/pcs	\$112.30
XSG402-AW**	Leaf Spring	Mill		Box	100/pcs	\$84.66
MSFG36X100-L00	36" x 100' Char Fiber Mesh	Charcoal	100'	Roll	400 ft <sup>2</sup>	\$184.80
SPFRD175-BX-L	.175" Diameter Foam Spline	Black	5,000'	Box	5,000'	\$413.60

\*\*Available in bulk quantities

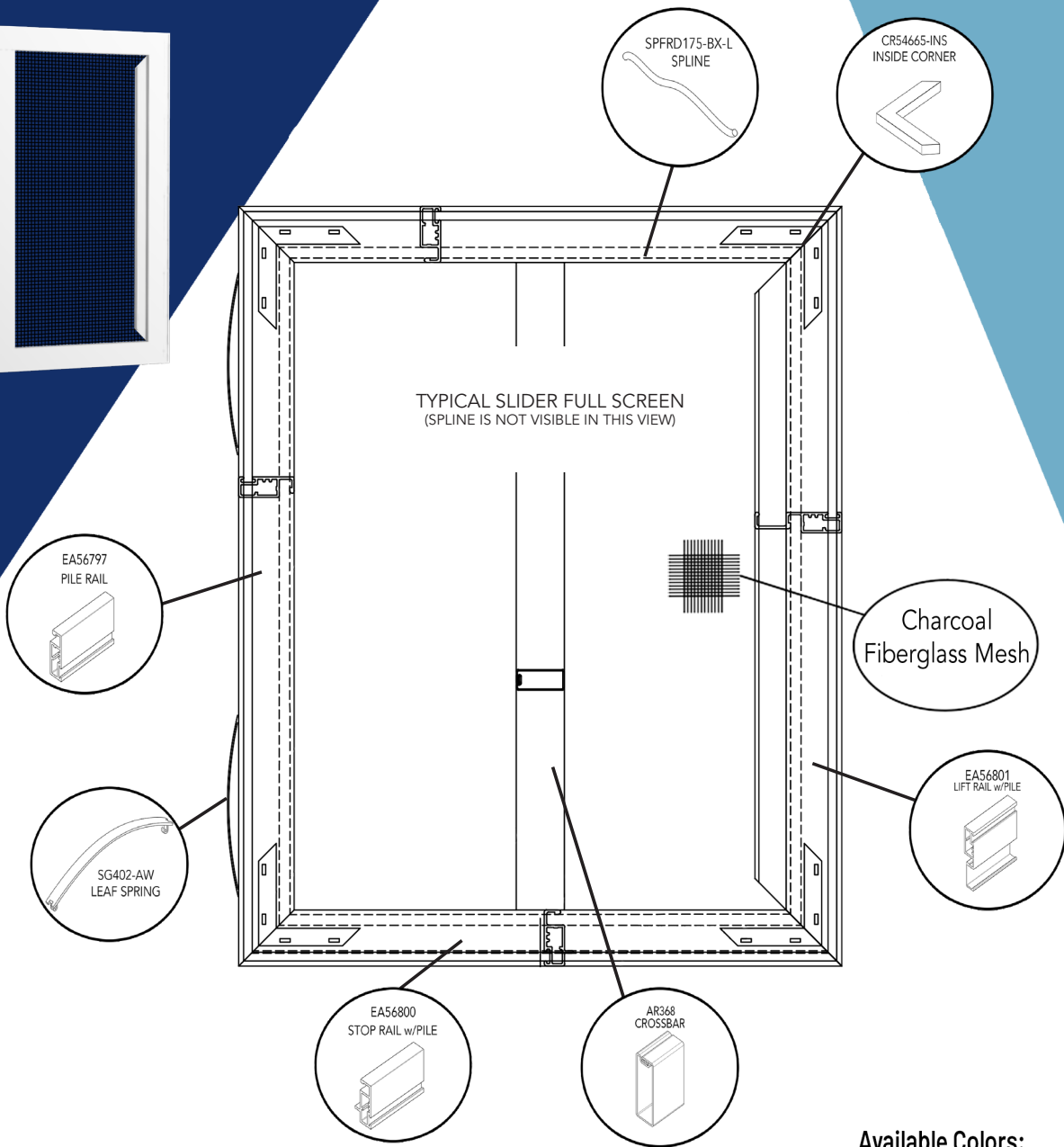
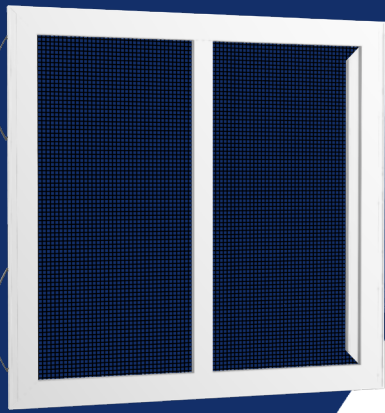

Available in  $\frac{5}{16}$ " ,  $\frac{3}{8}$ " and  $\frac{7}{16}$ " , contact RiteScreen for details.

### Available Colors:

XXX in part numbers are place holders for the Color Code

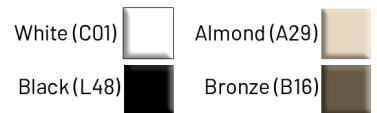

Series #	Fully Assembled Screen	Size	UOM	List Price
SL4	Minimum Price	0" to 49" UI	United Inch	\$38.10
SL4	U.I. Price	50" UI and Above	United Inch	\$0.7776

Part #	Description	Color	Length	UOM	QTY	List Price
EA56797-204-XXX	Pile Rail	See Chart	17'	Box	20/pcs	\$1,297.28
EA56800-204-XXX	Stop Rail w/Pile	See Chart	17'	Box	20/pcs	\$1,463.21
EA56801-204-XXX	Lift Rail w/Pile	See Chart	17'	Box	20/pcs	\$1,542.49
AR368-16-12XXX	Crossbar	See Chart	12.5'	Box	152/pcs	\$1,583.36
XCR54665-INS**	Inside Corner	Mill		Box	100/pcs	\$112.30
XSG402-AW**	Leaf Spring	Mill		Box	100/pcs	\$84.66
MSFG36X100-L00	36" x 100' Char Fiber Mesh	Charcoal	100'	Roll	400 ft <sup>2</sup>	\$184.80
SPFRD175-BX-L	.175" Diameter Foam Spline	Black	5,000'	Box	5,000'	\$413.60

\*\*Available in bulk quantities

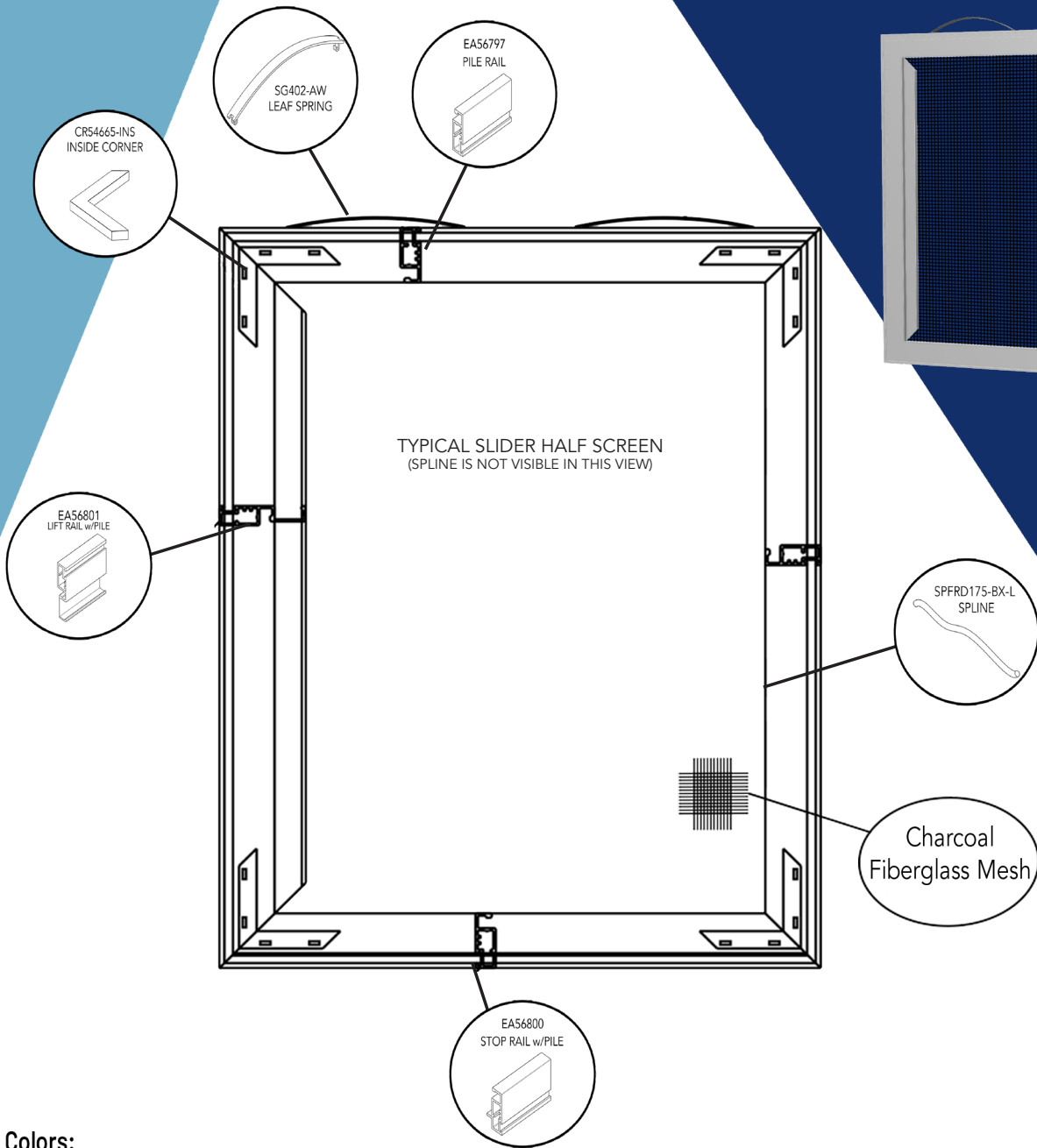

### Available Colors:

XXX in part numbers are  
place holders for the Color Code

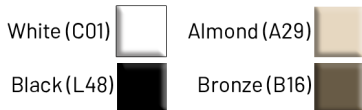

Available in  $\frac{5}{16}$ " ,  $\frac{3}{8}$ " and  $\frac{7}{16}$ " , contact  
RiteScreen for details.

Series #	Fully Assembled Screen	Size	UOM	List Price
SL5	Minimum Price	0" to 49" UI	United Inch	\$38.74
SL5	U.I. Price	50" UI and Above	United Inch	\$0.7908

Part #	Description	Color	Length	UOM	QTY	List Price
EA56797-204-XXX	Pile Rail	See Chart	17'	Box	20/pcs	\$1,297.28
EA56800-204-XXX	Stop Rail w/Pile	See Chart	17'	Box	20/pcs	\$1,463.21
EA56801-204-XXX	Lift Rail w/Pile	See Chart	17'	Box	20/pcs	\$1,542.49
XCR54665-INS**	Inside Corner	Mill		Box	100/pcs	\$112.30
XSG402-AW**	Leaf Spring	Mill		Box	100/pcs	\$84.66
MSFG36X100-L00	36" x 100' Char Fiber Mesh	Charcoal	100'	Roll	400 ft <sup>2</sup>	\$184.80
SPFRD175-BX-L	.175" Diameter Foam Spline	Black	5,000'	Box	5,000'	\$413.60

\*\*Available in bulk quantities



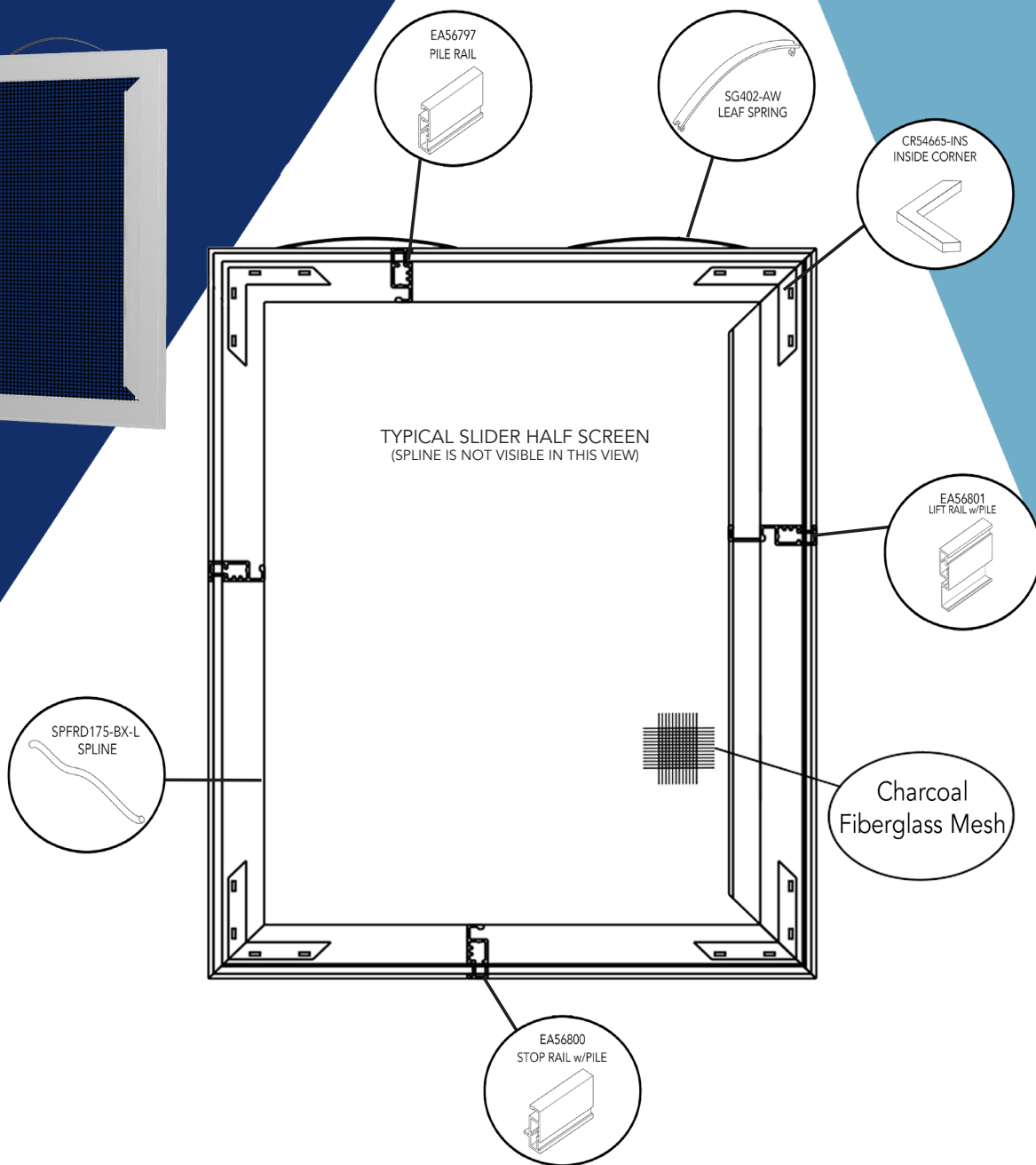
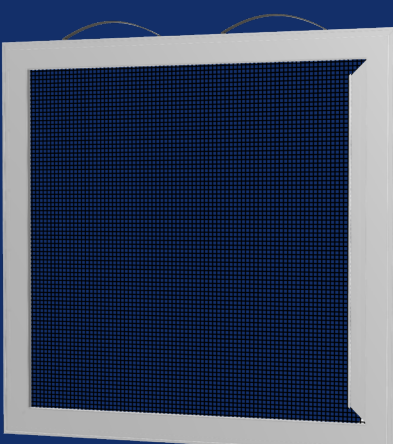

Available in  $\frac{5}{16}$ " ,  $\frac{3}{8}$ " and  $\frac{7}{16}$ " , contact RiteScreen for details.

### Available Colors:

XXX in part numbers are place holders for the Color Code

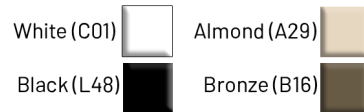

Series #	Fully Assembled Screen	Size	UOM	List Price
SL6	Minimum Price	0" to 49" UI	United Inch	\$38.74
SL6	U.I. Price	50" UI and Above	United Inch	\$0.7908

Part #	Description	Color	Length	UOM	QTY	List Price
EA56797-204-XXX	Pile Rail	See Chart	17'	Box	20/pcs	\$1,297.28
EA56800-204-XXX	Stop Rail w/Pile	See Chart	17'	Box	20/pcs	\$1,463.21
EA56801-204-XXX	Lift Rail w/Pile	See Chart	17'	Box	20/pcs	\$1,542.49
XCR54665-INS**	Inside Corner	Mill		Box	100/pcs	\$112.30
XSG402-AW**	Leaf Spring	Mill		Box	100/pcs	\$84.66
MSFG36X100-L00	36" x 100' Char Fiber Mesh	Charcoal	100'	Roll	400 ft <sup>2</sup>	\$184.80
SPFRD175-BX-L	.175" Diameter Foam Spline	Black	5,000'	Box	5,000'	\$413.60

\*\*Available in bulk quantities

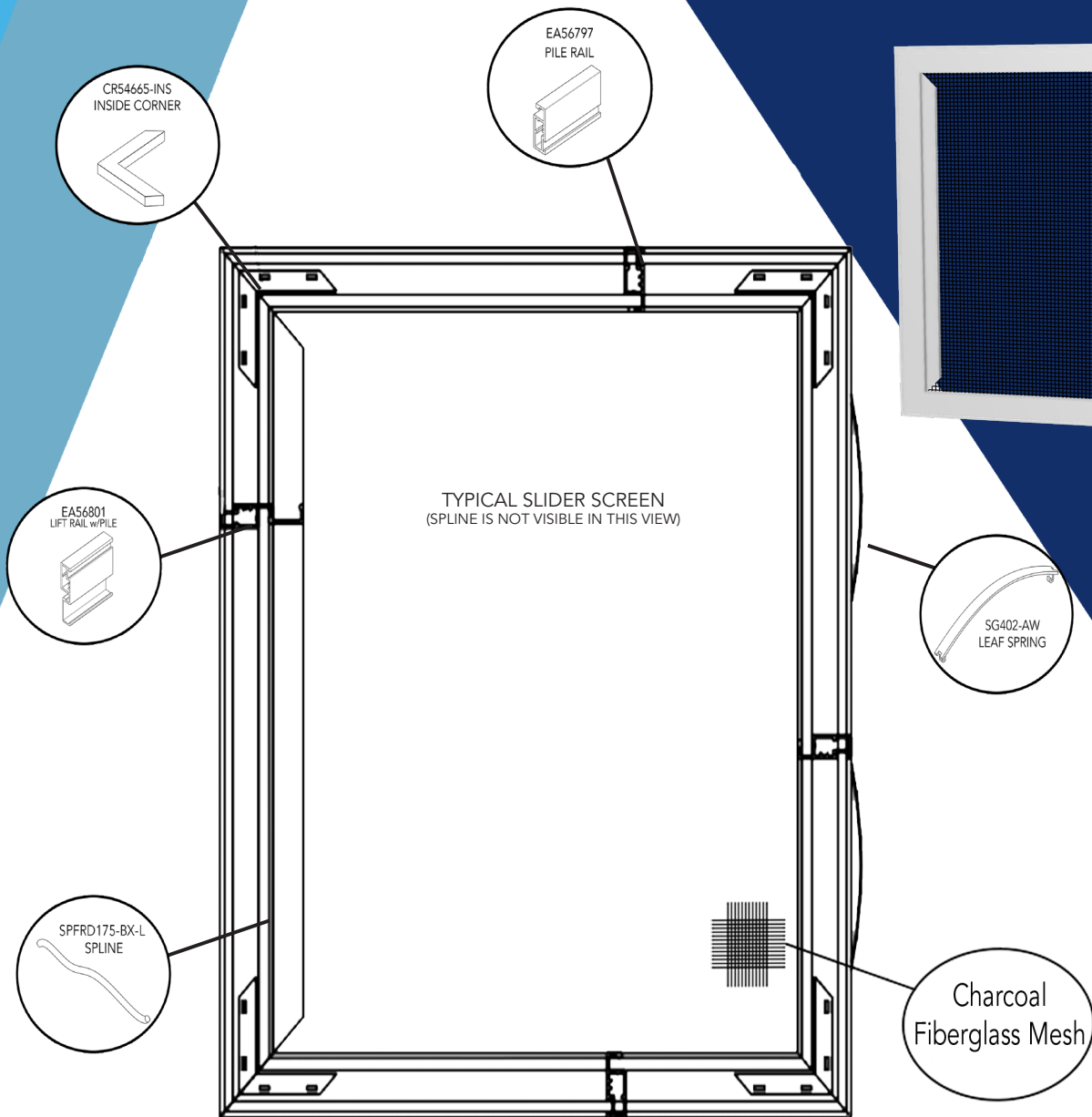

### Available Colors:

XXX in part numbers are  
place holders for the Color Code

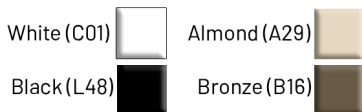

Available in  $\frac{5}{16}$ " ,  $\frac{3}{8}$ " and  $\frac{7}{16}$ " , contact  
RiteScreen for details.

\*Made in Pennsylvania

Series #	Fully Assembled Screen	Size	UOM	List Price
SL7	Minimum Price	0" to 49" UI	United Inch	\$38.74
SL7	U.I. Price	50" UI and Above	United Inch	\$0.7908

Part #	Description	Color	Length	UOM	QTY	List Price
EA56797-204-XXX	Pile Rail	See Chart	17'	Box	20/pcs	\$1,297.28
EA56801-204-XXX	Lift Rail w/Pile	See Chart	17'	Box	20/pcs	\$1,542.49
XCR54665-INS**	Inside Corner	Mill		Box	100/pcs	\$112.30
XSG402-AW**	Leaf Spring	Mill		Box	100/pcs	\$84.66
MSFG36X100-L00	36" x 100' Char Fiber Mesh	Charcoal	100'	Roll	400 ft <sup>2</sup>	\$184.80
SPFRD175-BX-L	.175" Diameter Foam Spline	Black	5,000'	Box	5,000'	\$413.60

\*\* Available in bulk quantities

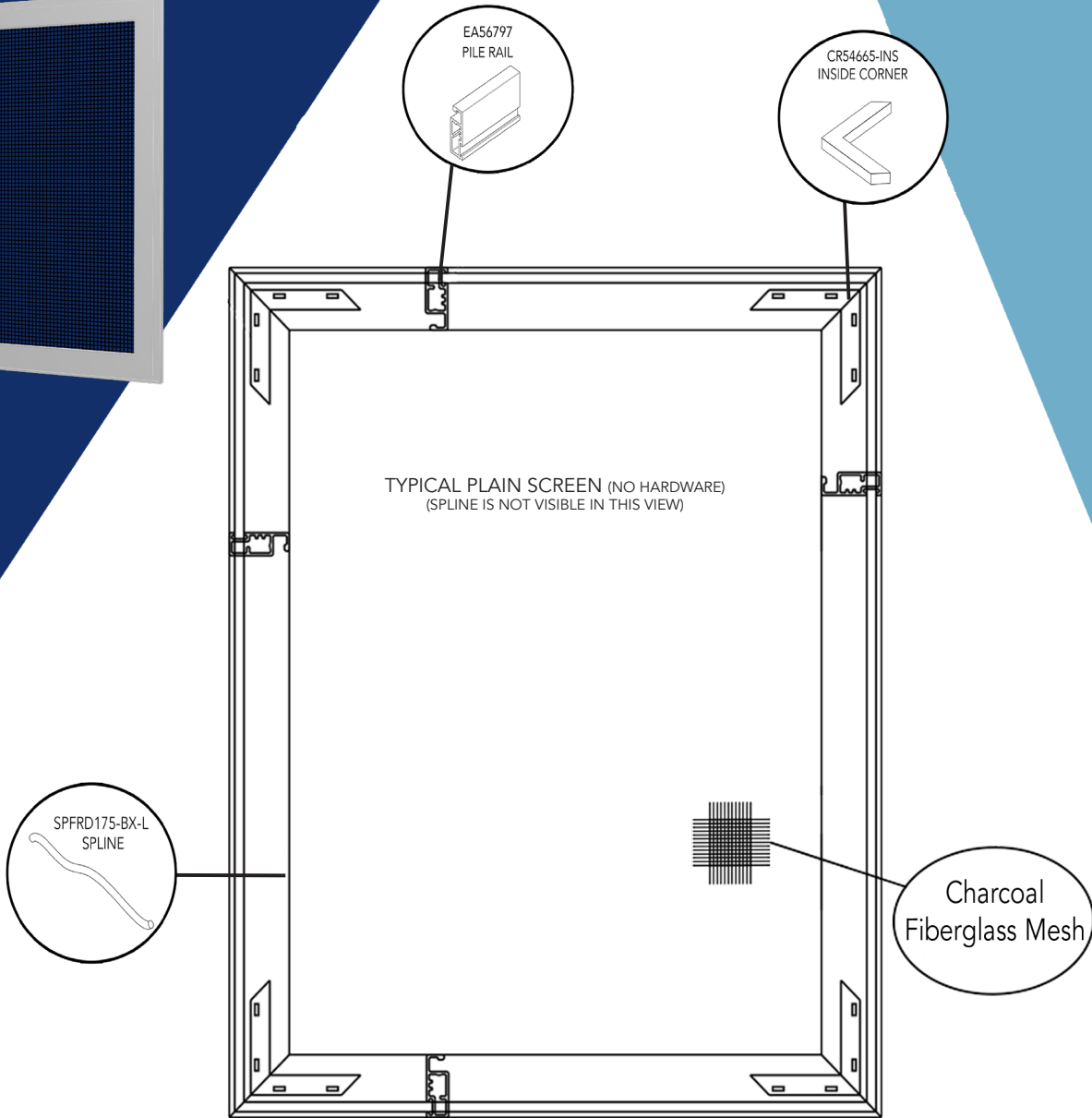
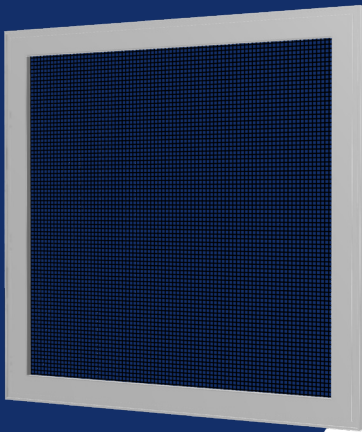

Available in  $\frac{5}{16}$ " ,  $\frac{3}{8}$ " and  $\frac{7}{16}$ " contact RiteScreen for details.

### Available Colors:

XXX in part numbers are place holders for the Color Code

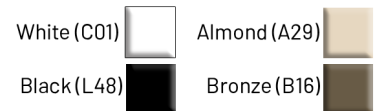

Series #	Fully Assembled Screen	Size	UOM	List Price
FS1	Minimum Price	0" to 49" UI	United Inch	\$35.46
FS1	U.I. Price	50" UI and Above	United Inch	\$0.7236

Part #	Description	Color	Length	UOM	QTY	List Price
EA56797-204-XXX	Pile Rail	See Chart	17'	Box	20/pcs	\$1,297.28
XCR54665-INS**	Inside Corner	Mill		Box	100/pcs	\$112.30
SPFRD175-BX-L	.175" Diameter Foam Spline	Black	5,000'	Box	5,000'	\$413.60
MSFG36X100-L00	36" x 100' Char Fiber Mesh	Charcoal	100'	Roll	400 ft <sup>2</sup>	\$184.80

\*\*Available in bulk quantities

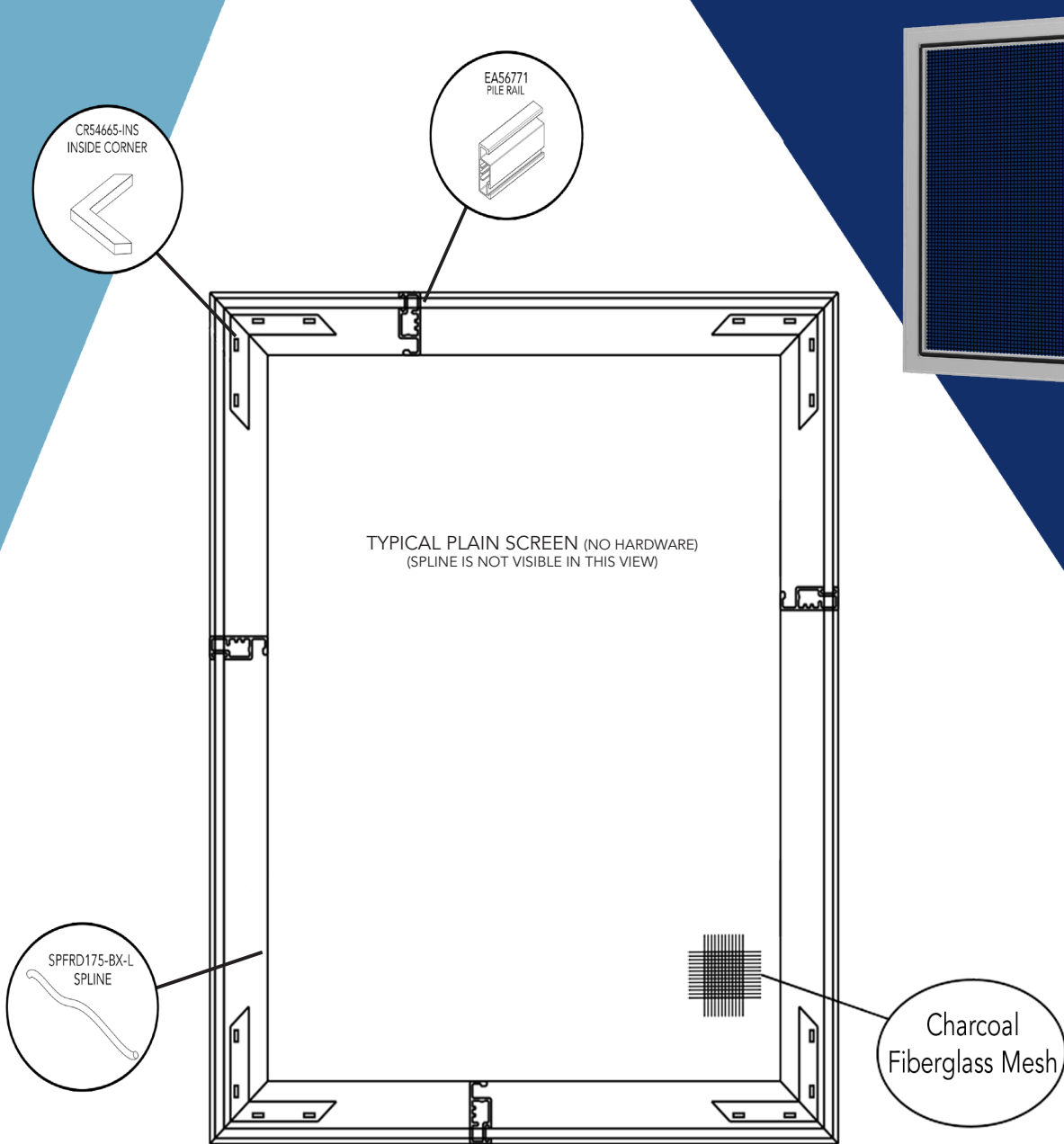

### Available Colors:

XXX in part numbers are place holders for the Color Code

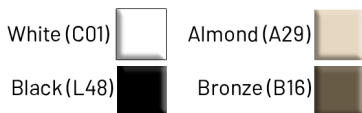

Available in  $\frac{5}{16}$ " ,  $\frac{3}{8}$ " and  $\frac{7}{16}$ " , contact RiteScreen for details.

Series #	Fully Assembled Screen	Size	UOM	List Price
FS2	Minimum Price	0" to 49" UI	United Inch	\$35.46
FS2	U.I. Price	50" UI and Above	United Inch	\$0.7236

Part #	Description	Color	Length	UOM	QTY	List Price
EA56771-187-XXX	Pile Rail	See Chart	15.5'	Box	20/pcs	\$1,297.28
XCR54665-INS**	Inside Corner	Mill		Box	100/pcs	\$112.30
SPFRD175-BX-L	.175" Diameter Foam Spline	Black	5,000'	Box	5,000'	\$413.60
MSFG36X100-L00	36" x 100' Char Fiber Mesh	Charcoal	100'	Roll	400 ft <sup>2</sup>	\$184.80

\*\*Available in bulk quantities

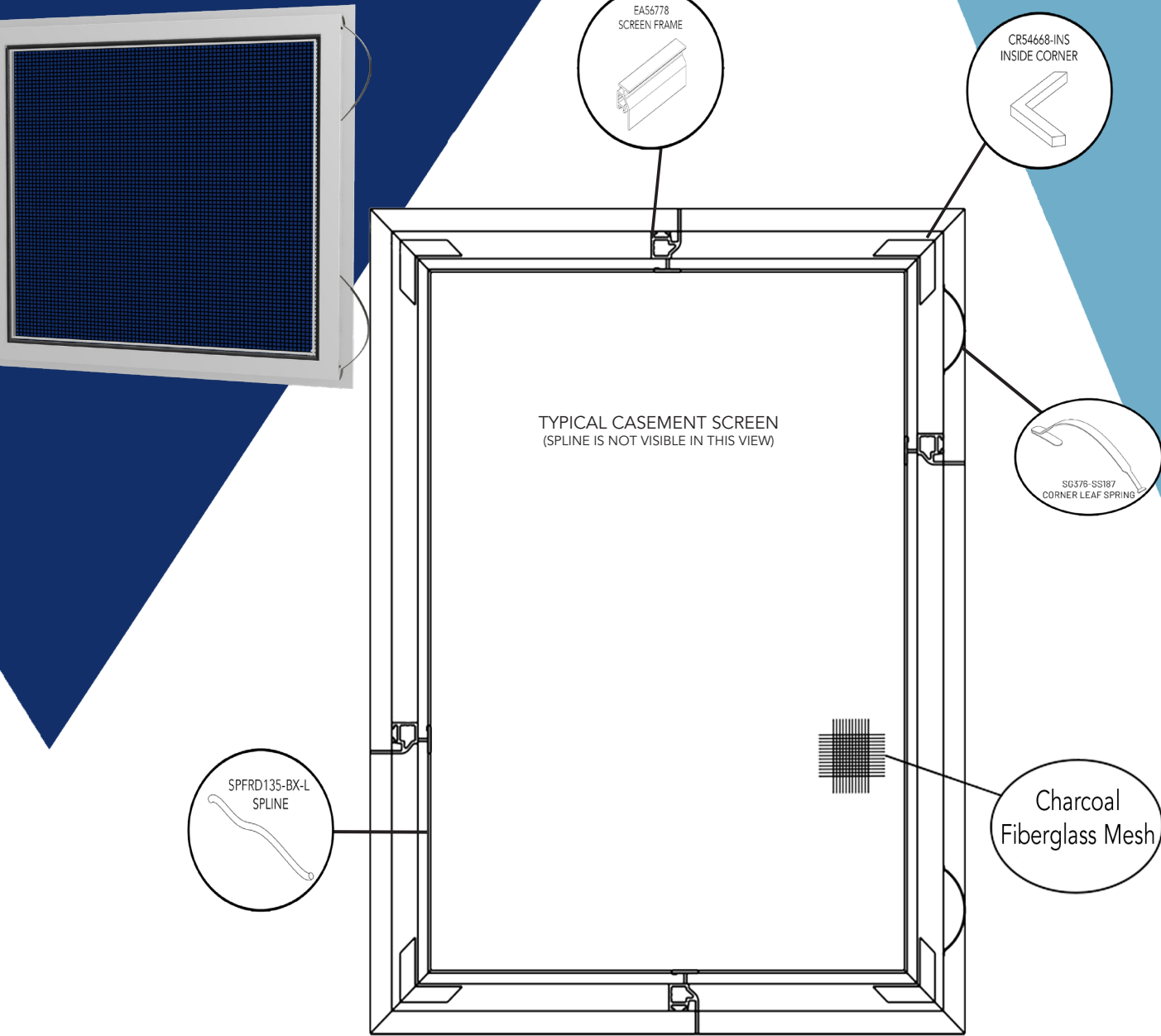

Only available in 3/8"

**Available Colors:**

XXX in part numbers are place holders for the Color Code

Black (L48)	
White (C01)	
Almond (A29)	
Clay (A22)	
Bronze (B16)	

Series #	Fully Assembled Screen	Size	UOM	List Price
CA1	Minimum Price	0" to 49" UI	United Inch	\$39.68
CA1	U.I. Price	50" UI and Above	United Inch	\$0.8096

Part #	Description	Color	Length	UOM	QTY	List Price
EA56778-204-XXX	Screen Frame	See Chart	17'	Box	20/pcs	\$1,352.80
XCR54668-INS**	Inside Corner	Mill		Box	100/pcs	\$153.83
XSG376-SS187**	Corner Leaf Spring	Mill		Box	100/pcs	\$181.20
MSFG36X100-L00	36" x 100' Char Fiber Mesh	Charcoal	100'	Roll	400 ft <sup>2</sup>	\$184.80
SPFRD135-BX-L	.135" Diameter Foam Spline	Black	8,000'	Box	8,000'	\$598.40

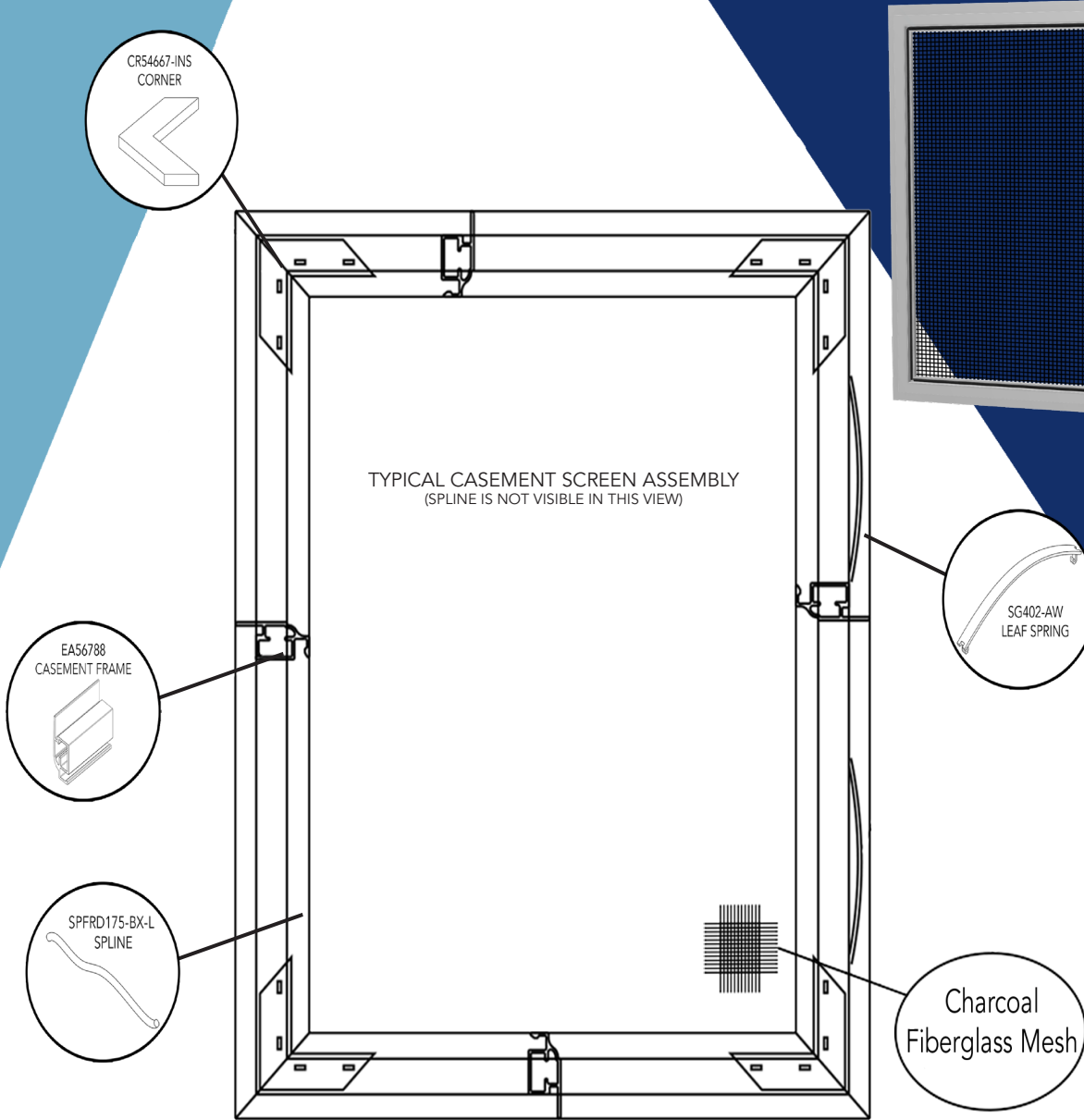

### Available Colors:

XXX in part numbers are place holders for the Color Code

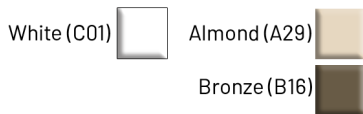

Only available in 7/16"

Series #	Fully Assembled Screen	Size	UOM	List Price
CA2	Minimum Price	0" to 49" UI	United Inch	\$45.42
CA2	U.I. Price	50" UI and Above	United Inch	\$0.9268

Part #	Description	Color	Length	UOM	QTY	List Price
EA56788-209-XXX	Casement Frame	See Chart	17.5'	Box	20/pcs	\$1,721.03
XCR54667-INS**	Corner	Mill		Box	100/pcs	\$133.24
XSG402-AW**	Leaf Spring	Mill		Box	100/pcs	\$84.66
MSFG36X100-L00	36" x 100' Char Fiber Mesh	Charcoal	100'	Roll	400 ft <sup>2</sup>	\$184.80
SPFRD175-BX-L	.175" Diameter Foam Spline	Black	5,000'	Box	5,000'	\$413.60

\*\*Available in bulk quantities

# CA3 - Extruded Awning Screen

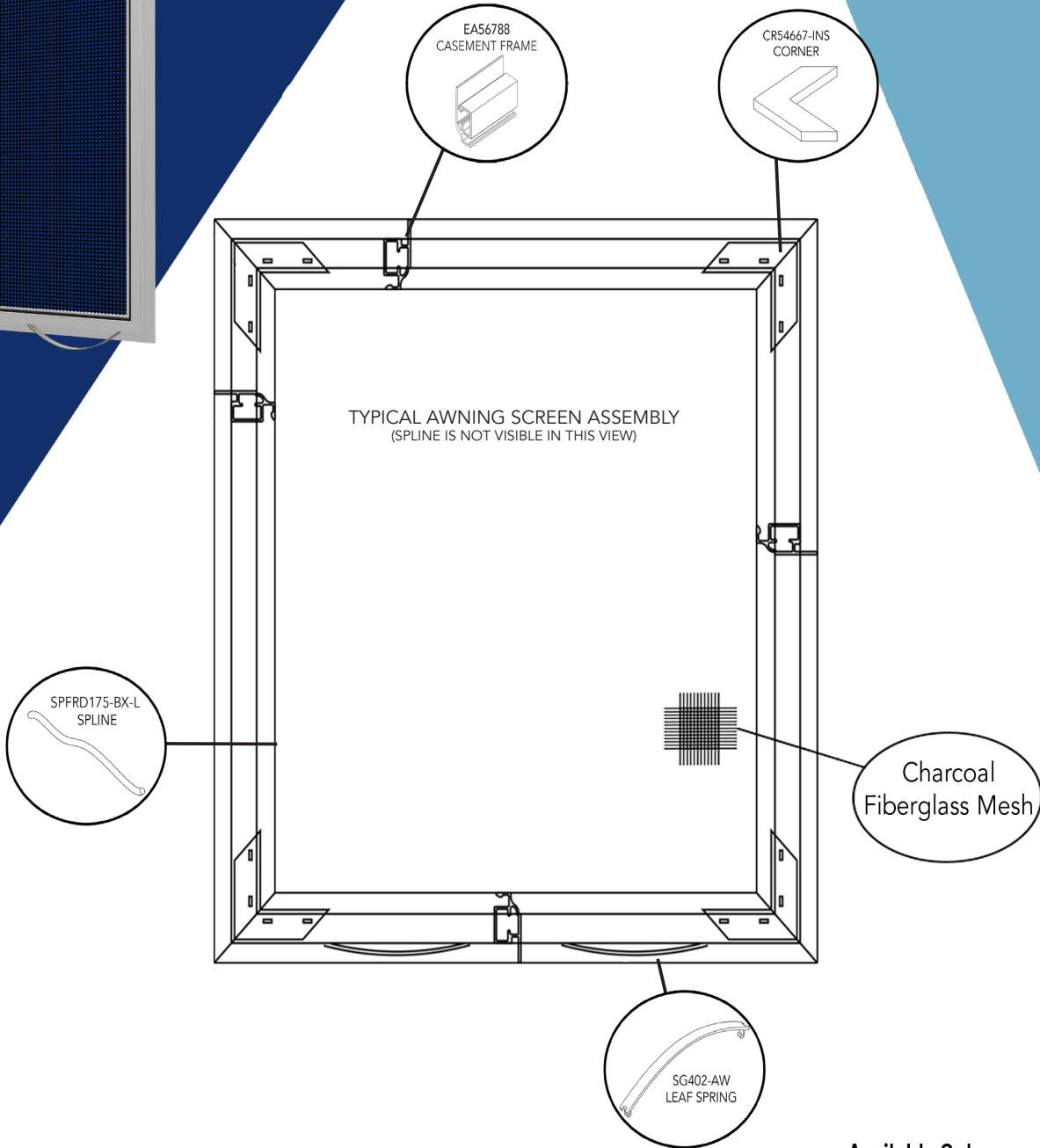
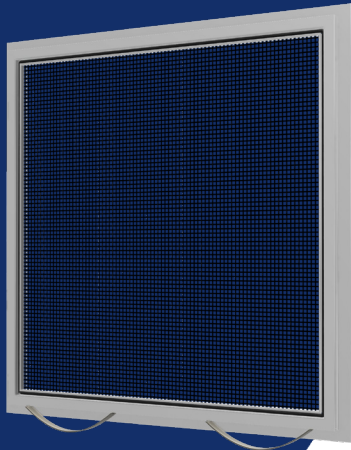

Only available in 7/16"

### Available Colors:

XXX in part numbers are place holders for the Color Code

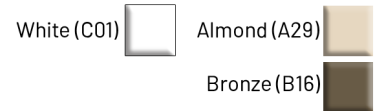

Series #	Fully Assembled Screen	Size	UOM	List Price
CA3	Minimum Price	0" to 49" UI	United Inch	\$39.32
CA3	U.I. Price	50" UI and Above	United Inch	\$0.8024

Part #	Description	Color	Length	UOM	QTY	List Price
EA56788-209-XXX	Casement Frame	See Chart	17.5'	Box	20/pcs	\$1,721.03
XCR54667-INS**	Corner	Mill		Box	100/pcs	\$133.24
XSG402-AW**	Leaf Spring	Mill		Box	100/pcs	\$84.66
MSFG36X100-L00	36" x 100' Char Fiber Mesh	Charcoal	100'	Roll	400 ft <sup>2</sup>	\$184.80
SPFRD175-BX-L	.175" Diameter Foam Spline	Black	5,000'	Box	5,000'	\$413.60

\*\*Available in bulk quantities

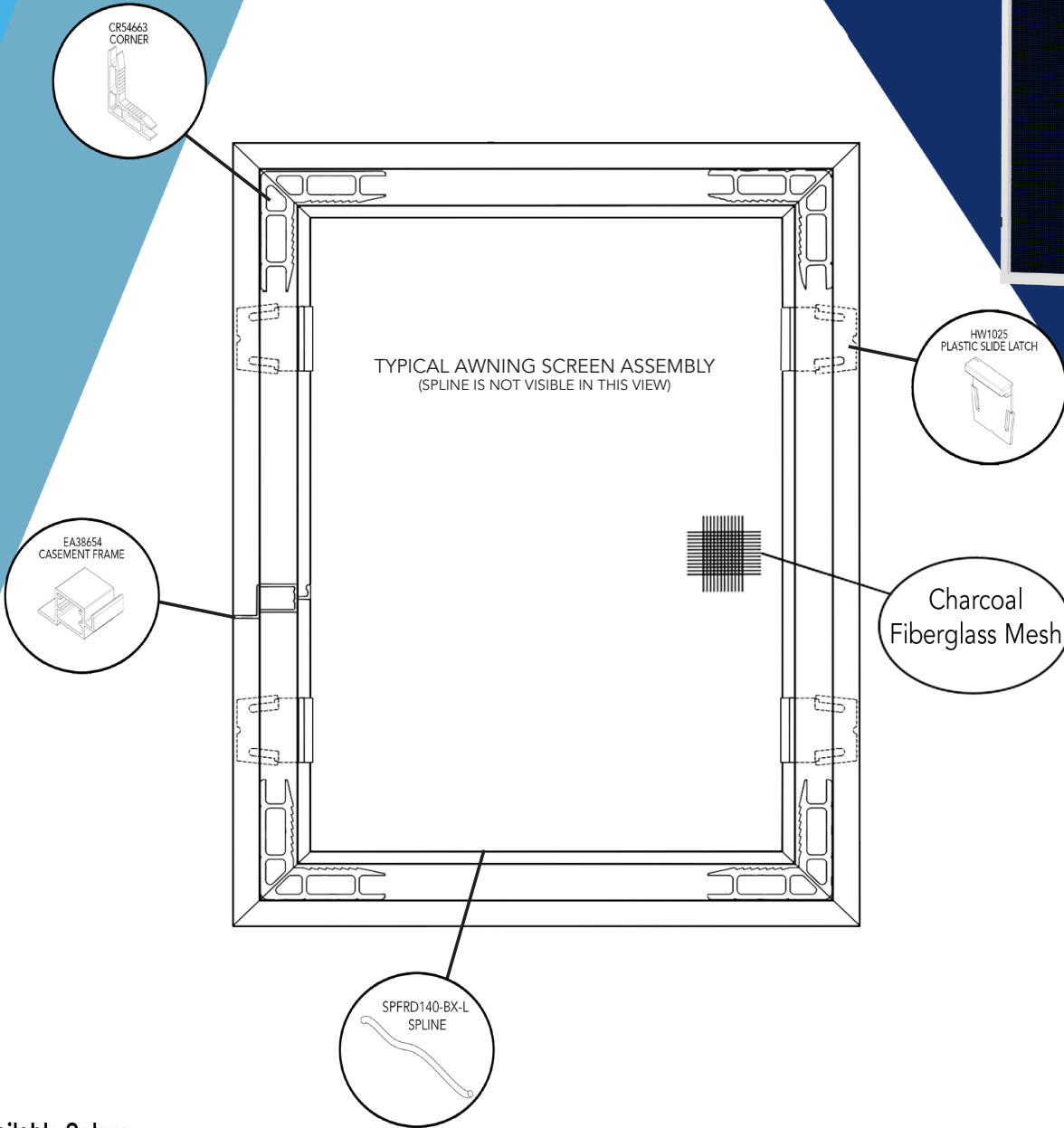
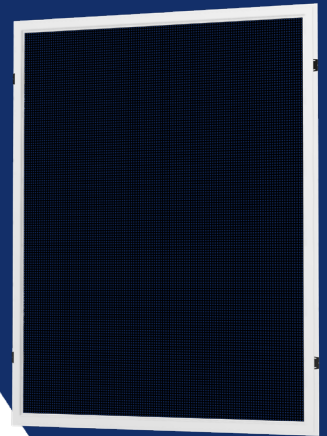

### Available Colors:

XXX in part numbers are  
placeholders for the Color Code

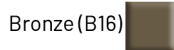
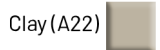
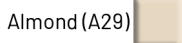
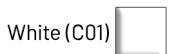
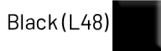

Only available in 7/16"

Series #	Fully Assembled Screen	Size	UOM	List Price
CA4	Minimum Price	0" to 49" UI	United Inch	\$44.14
CA4	U.I. Price	50" UI and Above	United Inch	\$0.9010

Part #	Description	Color	Length	UOM	QTY	List Price
EA38654-156-XXX	Casement Frame	See Chart	13'	Box	20/pcs	\$1,261.26
XCR54663-328-IS**	Inside Corner	Mill		Box	100/pcs	\$108.34
XHW1025-XXX**	Plastic Side Latch	White or Black		Box	100/pcs	\$95.84
MSFG36X100-L00	36" x 100' Char Fiber Mesh	Charcoal	100'	Roll	400 ft <sup>2</sup>	\$184.80
SPFRD140-BX-L	Foam Spline	Black	8,000'	Box	8,000'	\$612.48

\*\*Available in bulk quantities



# CA5 - Extruded Casement Screen

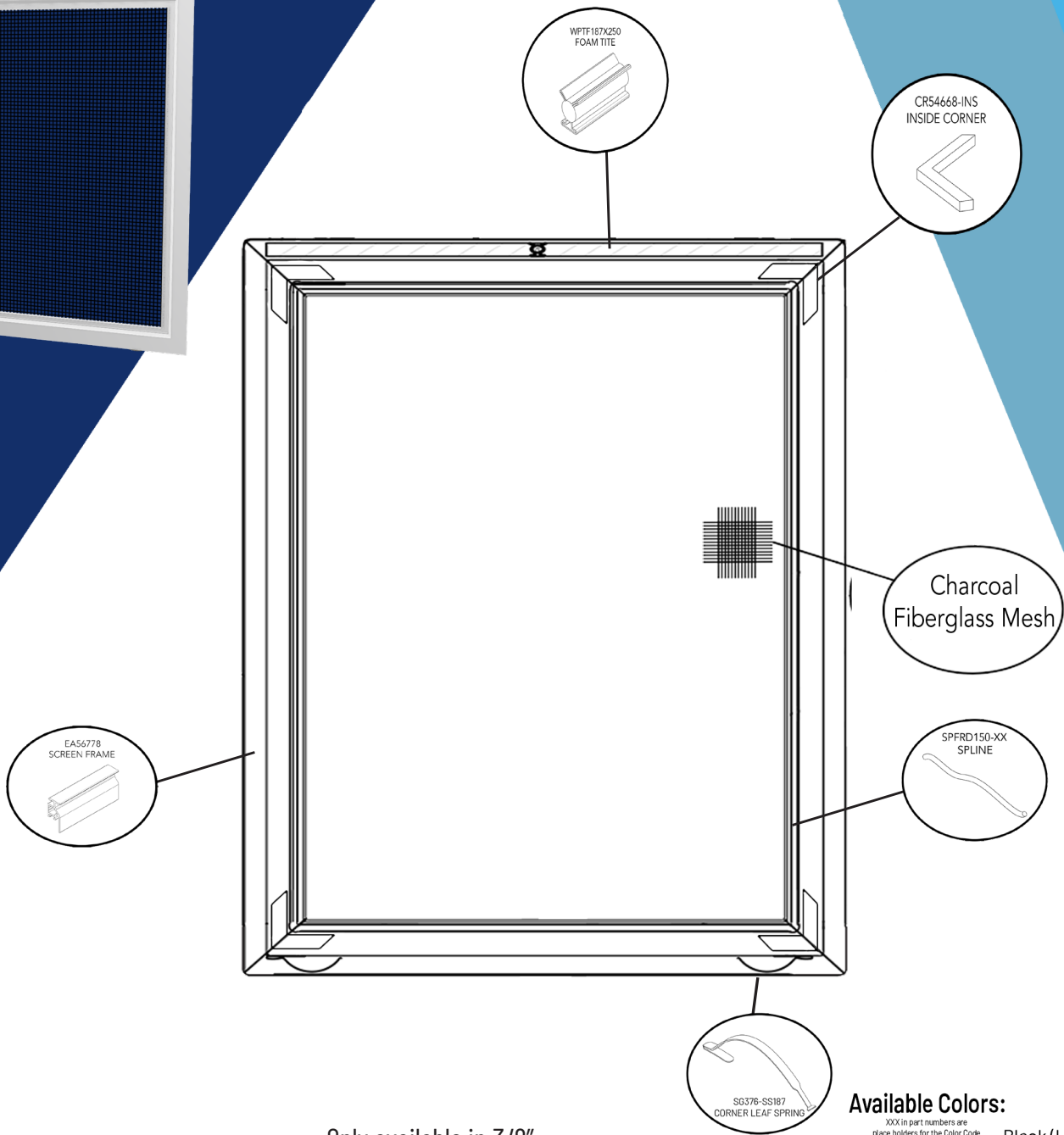
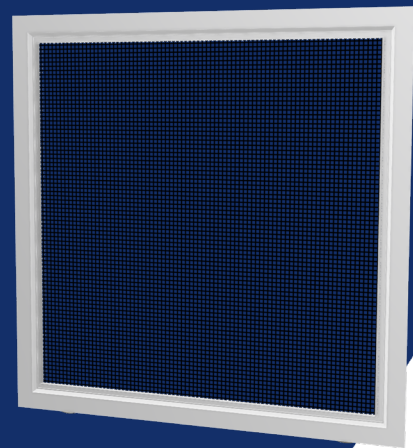

Only available in 3/8"

### Available Colors:

XXX in part numbers are place holders for the Color Code

- Black (L48)
- White (C01)
- Almond (A29)
- Clay (A22)
- Bronze (B16)

Series #	Fully Assembled Screen	Size	UOM	List Price
CA5	Minimum Price	0" to 49" UI	United Inch	\$45.00
CA5	U.I. Price	50" UI and Above	United Inch	\$,9814

Part #	Description	Color	Length	UOM	QTY	List Price
EA56778-204-XXX	Screen Frame	See Chart	17'	Box	20/ea	\$1,352.80
XCR54668-INS**	Inside Corner	Mill		Box	100/pcs	\$153.83
WPTF187X250	Woolpile Foam, T-Slot	Natural	1000'	Box	1000'	\$1012.00
XSG376-SS187**	Corner Leaf Spring	Mill		Box	100/pcs	\$181.20
MSFG36X100-L00	36" x 100' Char Fiber Mesh	Charcoal	100'	Roll	400 ft <sup>2</sup>	\$184.80
SPFRD150-BX-L	.150" Foam Spline	Black	8,000'	Box	8,000'	\$469.92

\*\*Available in bulk quantities

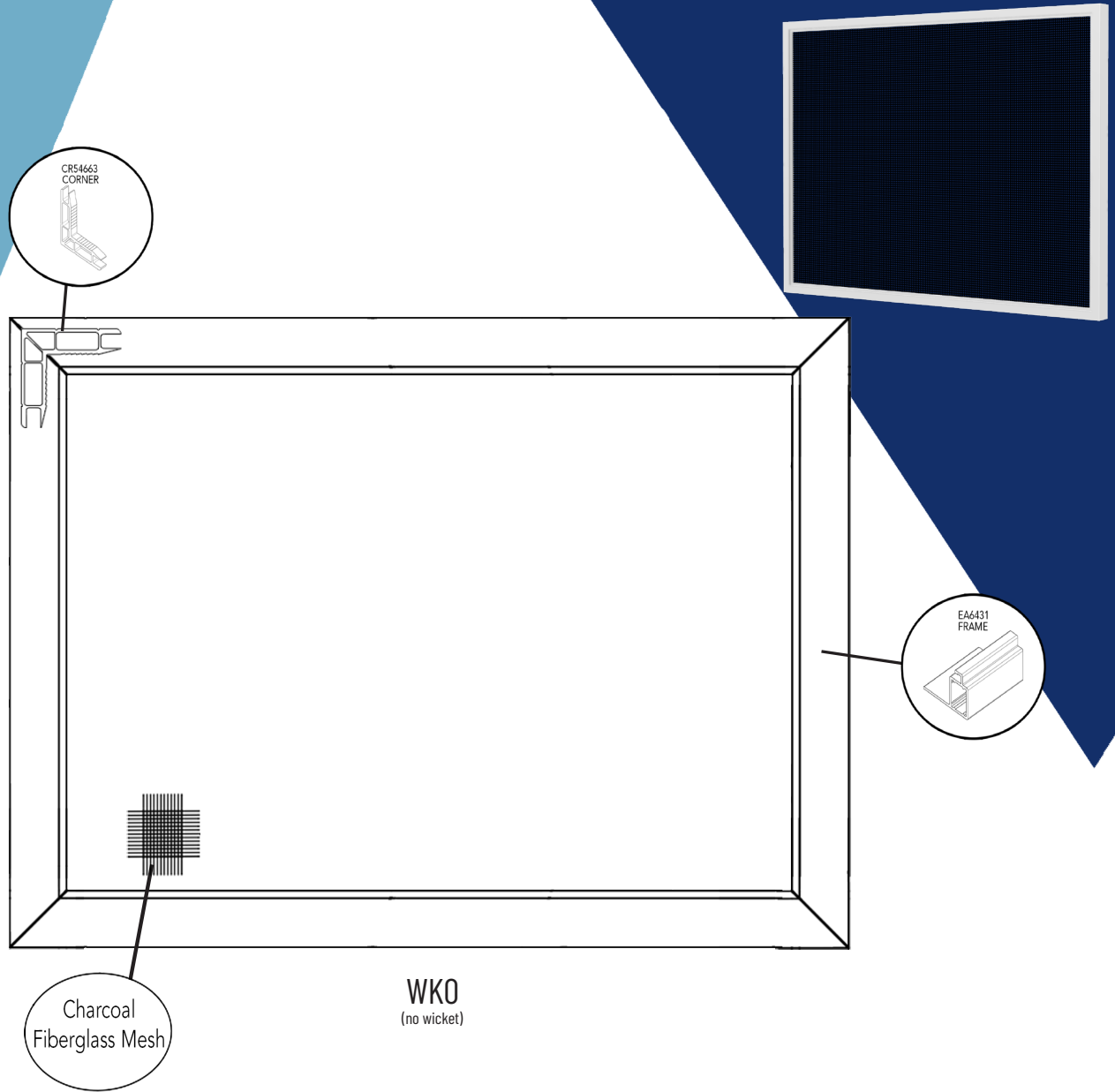

**WK0**  
(no wicket)

### AVAILABLE COLORS

XXX in part numbers are  
place holders for Color Code



Series #	Fully Assembled Screen	Size	UOM	List Price
WK0	Minimum Price (applies to WK1L, WK1R)	0" to 49" UI	United Inch	\$89.95
WK0	U.I. Price (applies to WK1L, WK1R)	50" UI and Above	United Inch	\$1.84

Part #	Description	Color	Length	UOM	QTY	List Price
WEA6431-150-XXX	Stand-off Frame	See Chart	12.5'	Box	20/pcs	\$1128.60
XCR54663-328-IS**	Corner	Mill		Box	100/pcs	\$108.34
WK828-B-X	Wicket	Black		Box	200	\$2,147.20
MSFG36X100-L00	36" x 100' Char Fiber Mesh	Charcoal	100'	Roll	400 ft <sup>2</sup>	\$184.80

\*\*Available in bulk quantities

# WK1 - Extruded Hinged Wicket Screen



## Configurations Available

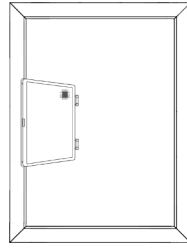
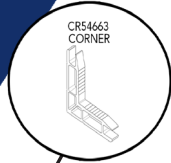
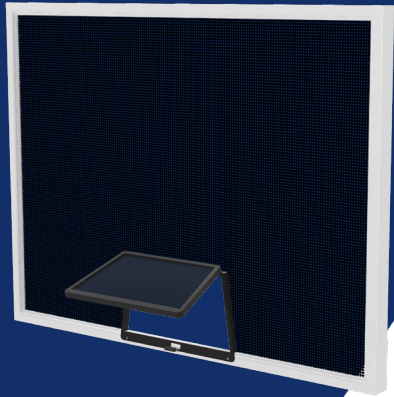

WK1L

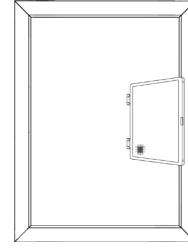

WK1R

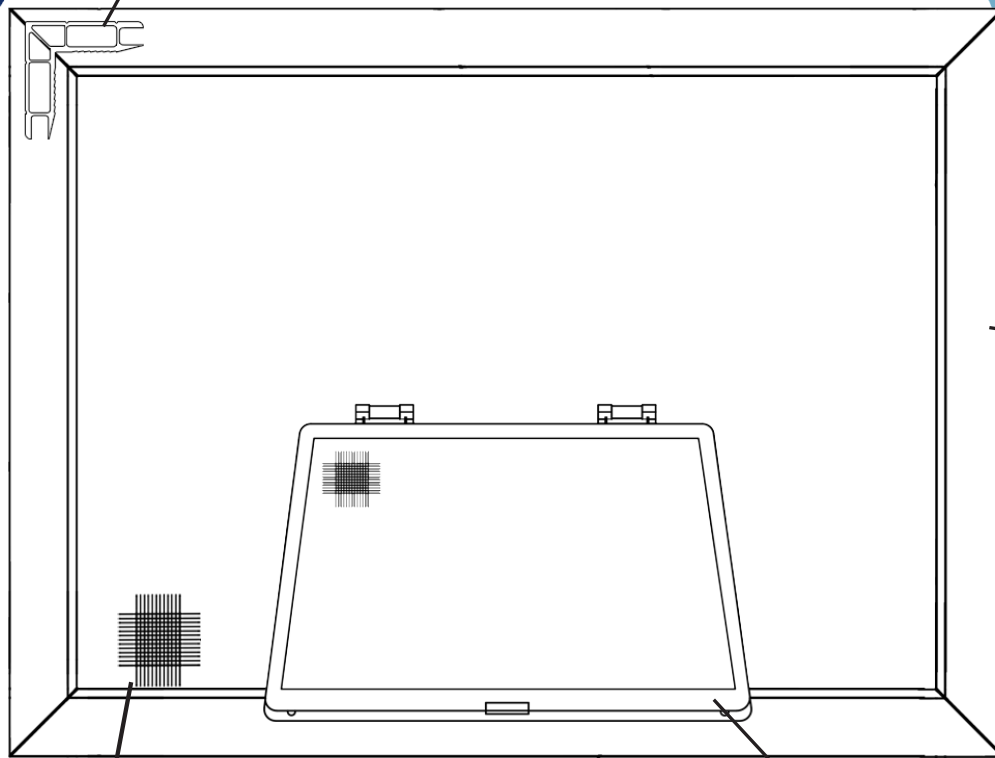

Charcoal Fiberglass Mesh

WK1

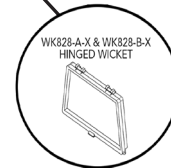

WK828-A-X & WK828-B-X HINGED WICKET

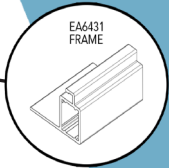

EA6431 FRAME

Series #	Fully Assembled Screen	Size	UOM	List Price
WK1	Minimum Price (applies to WK1L, WK1R)	0" to 49" UI	United Inch	\$89.95
WK1	U.I. Price (applies to WK1L, WK1R)	50" UI and Above	United Inch	\$1.84

### AVAILABLE COLORS

XXX in part numbers are place holders for Color Code



Part #	Description	Color	Length	UOM	QTY	List Price
WEA6431-150-XXX	Stand-off Frame	See Chart	12.5'	Box	20/pcs	\$1128.60
XCR54663-328-IS**	Corner	Mill		Box	100/pcs	\$108.34
WK828-B-X	Wicket	Black		Box	200	\$2,147.20
MSFG36X100-L00	36" x 100' Char Fiber Mesh	Charcoal	100'	Roll	400 ft <sup>2</sup>	\$184.80

## Configurations Available

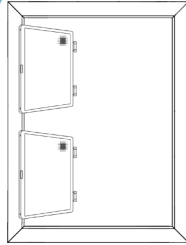

WK2L

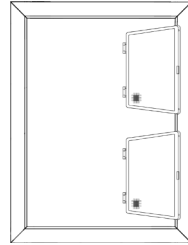

WK2R

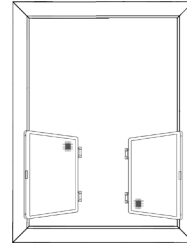

WK2LR

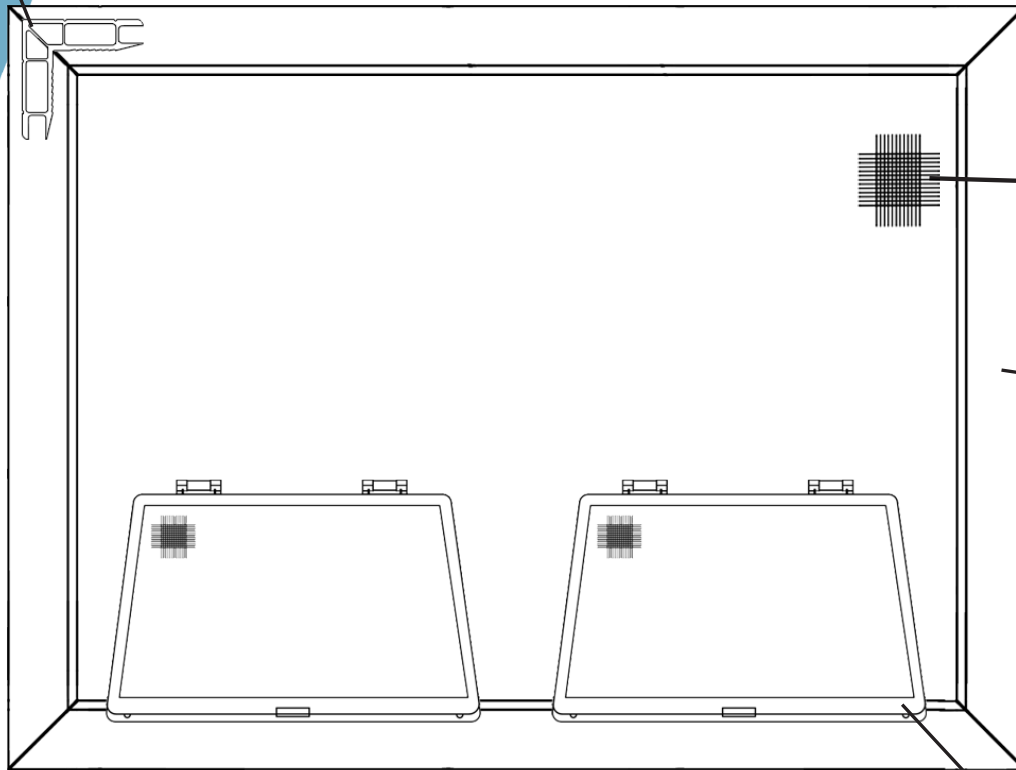
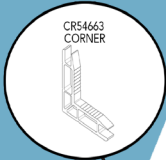
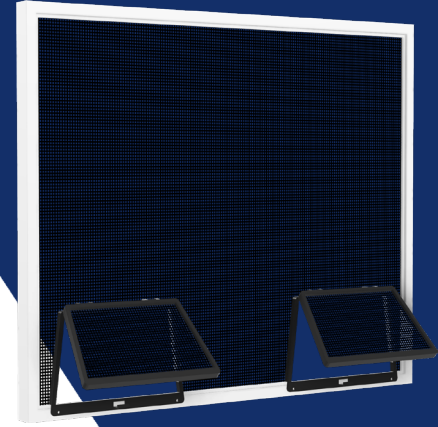

Charcoal  
Fiberglass Mesh

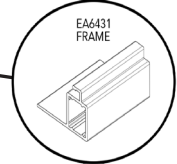

WK2

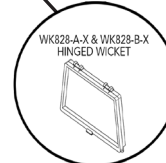

### AVAILABLE COLORS

XXX in part numbers are  
place holders for Color Code



Black (L48) White (C01) Bronze (B16)

Series #	Fully Assembled Screen	Size	UOM	List Price
WK2	Minimum Price (applies to WK2L, WK2R, WK2LR)	0" to 49" UI	United Inch	\$106.69
WK2	U.I. Price (applies to WK2L, WK2R, WK2LR)	50" UI and Above	United Inch	\$2.18

Part #	Description	Color	Length	UOM	QTY	List Price
WEA6431-150-XXX	Stand-off Frame	See Chart	12.5'	Box	20/pcs	\$1128.60
XCR54663-328-IS**	Corner	Mill		Box	100/pcs	\$108.34
WK828-B-X	Wicket	Black		Box	200	\$2,147.20
MSFG36X100-L00	36" x 100' Char Fiber Mesh	Charcoal	100'	Roll	400 ft <sup>2</sup>	\$184.80

# RS-505223

## Tilt & Turn w/ Swivels

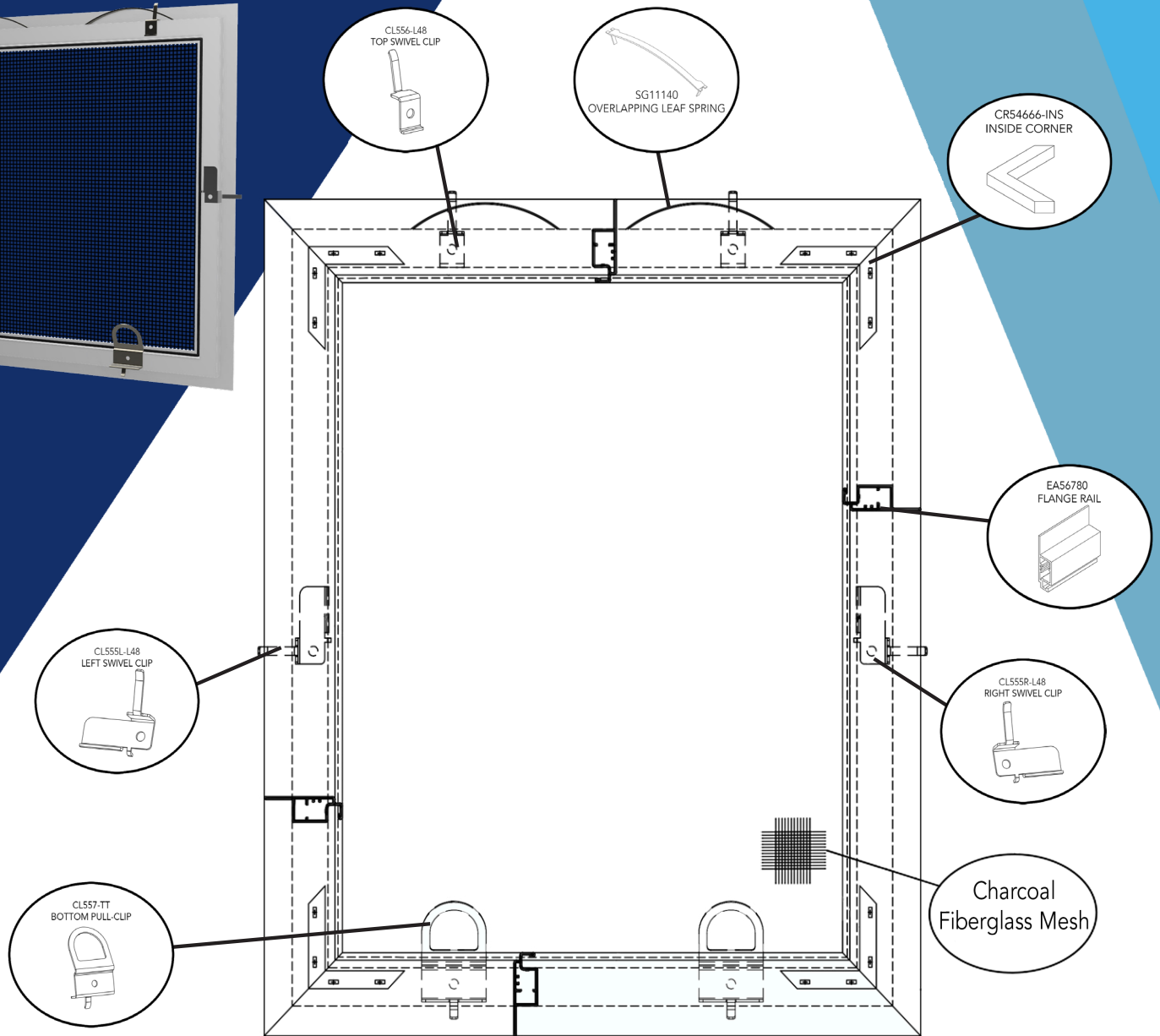
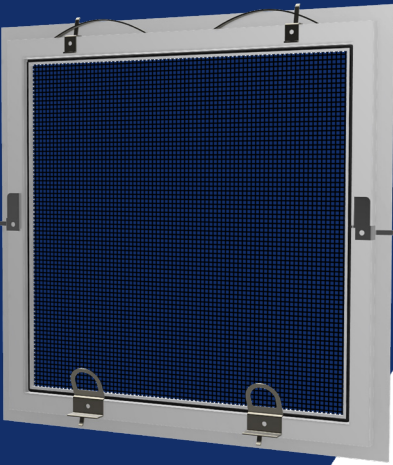

### AVAILABLE COLORS

XXX in part numbers are place holders for Color Code



Series #	Fully Assembled Screen	Size	UOM	List Price
RS-505223	Minimum Price	0" to 49" UI	United Inch	\$75.55
RS-505223	U.I. Price	50" UI and Above	United Inch	\$1.5419

Part #	Description	Color	Length	UOM	QTY	List Price
EA56780-229-XXX	Flange Rail	See Chart	19'	Box	20/pcs	\$1,593.07
XCR54666-INS	Inside Corner	Mill		Box	100/pcs	\$127.17
XCL556-L48	Top Swivel Clip	Mill		Box	100/pcs	\$291.20
XCL555R/L-L48	Right/Left Swivel Clip	Mill		Box	100/pcs	\$317.60
XSG11140**	Overlapping Leaf Spring	Mill		Box	100/pcs	\$109.92
XCL557-TT	Bottom Pull-Clip	Mill		Box	100/pcs	\$454.24
MSFG36X100-L00	36" x 100' Char Fiber Mesh	Charcoal	100'	Roll	400 ft <sup>2</sup>	\$184.80
SPFRD150-BX-L	.150" Foam Spline	Black	8,000'	Box	8,000'	\$469.92

\*\*Available in bulk quantities

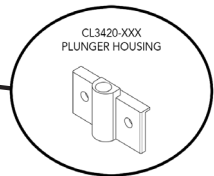
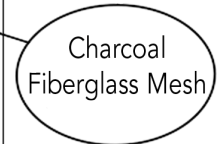
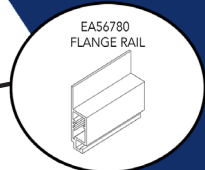
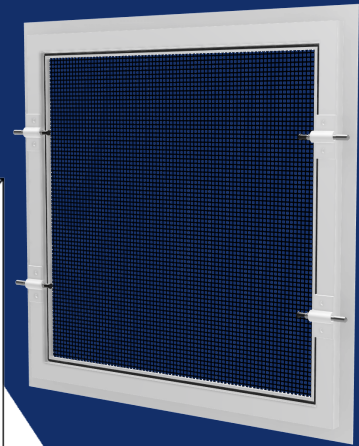
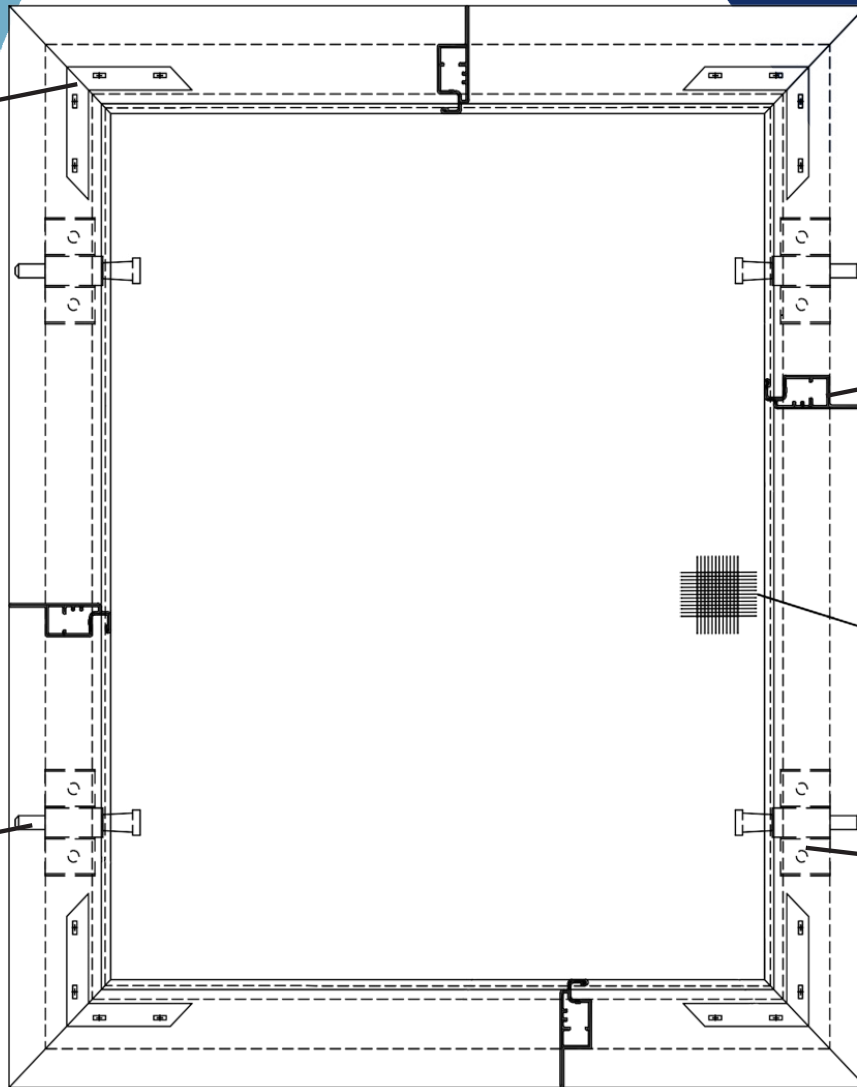
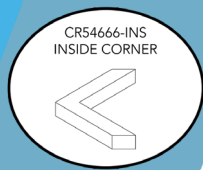

### AVAILABLE COLORS

XXX in part numbers are place holders for Color Code



Series #	Fully Assembled Screen	Size	UOM	List Price
RS-505224	Minimum Price	0" to 49" UI	United Inch	\$64.19
RS-505224	U.I. Price	50" UI and Above	United Inch	\$1.3101

Part #	Description	Color	Length	UOM	QTY	List Price
EA56780-229-XXX	Flange Rail	See Chart	19'	Box	20/pcs	\$1,593.07
XCR54666-INS	Inside Corner	Mill		Box	100/pcs	\$127.17
XCL3420-XXX	Plunger Housing	White or Bronze		Box	100/pcs	\$146.00
PL315/SG412/PL308-XXX	Plunger Assembly	See Component Section for Pricing				
MSFG36X100-L00	36" x 100' Char Fiber Mesh	Charcoal	100'	Roll	400 ft <sup>2</sup>	\$184.80
SPFRD150-BX-L	.150" Foam Spline	Black	8,000'	Box	8,000'	\$469.92

\*\*Available in bulk quantities



# ROLL-FORMED WINDOW SCREENS



A woman with blonde hair in a ponytail, wearing a beige cardigan and blue jeans, is sitting on a white toilet in a bathroom. She is looking out a window to the left. The background shows a window with greenery outside and a dark cabinet to the right.

**Our roll-formed screen frame was developed by RiteScreen engineers and is shaped in-house.**



# RFSH1 - Roll-Formed Single Hung Screen

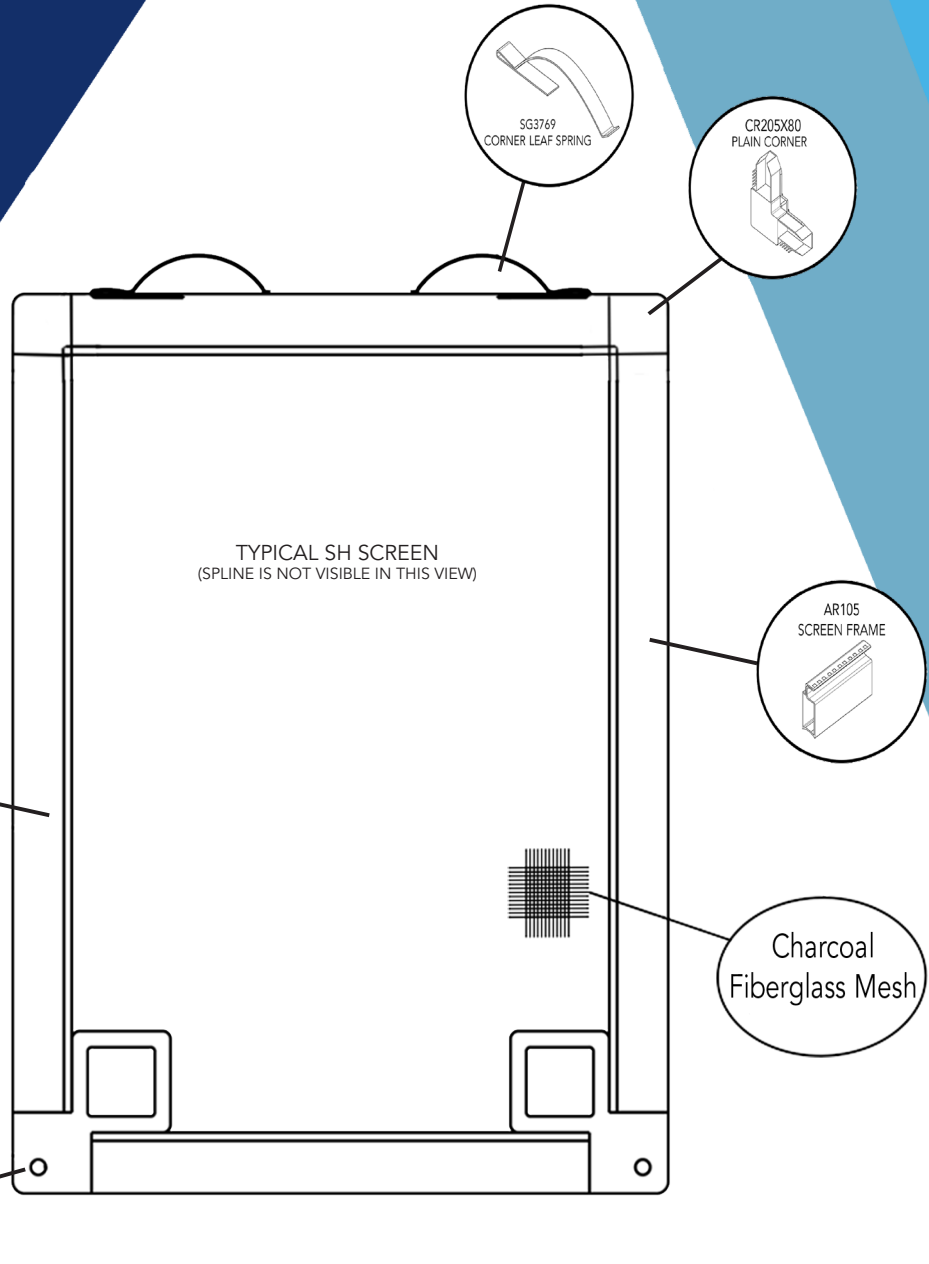
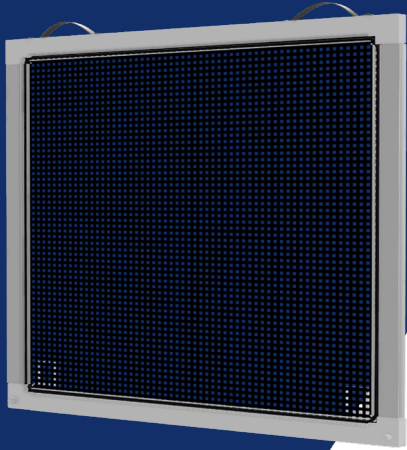

Shown in  $\frac{5}{16}$ ". Also available in  $\frac{3}{8}$ " and  $\frac{7}{16}$ ", contact RiteScreen for details.

### Standard Colors:

XXX in part numbers are place holders for Color Code

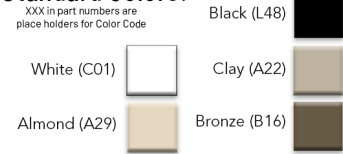

Series #	Fully Assembled Screen	Size	UOM	List Price
RFSH1	Minimum Price	0" to 49" UI	United Inch	\$22.58
RFSH1	U.I. Price	50" UI and Above	United Inch	\$0.4608
RFSH1-W	With Woolpile	50" UI and Above	United Inch	\$0.5174

Part #	Description	Color	Length	UOM	QTY	List Price
AR105-16-12XXX	Screen Frame	Standard	12.5'	Box	152/pcs	\$1,583.72
XCR205X80-XXX**	Plain Corner	Standard		Box	100/pcs	\$87.30
XCR205PSX80-XXX**	Corner Pull w/Stop	Standard		Box	100/pcs	\$98.39
XSG3769**	Leaf Spring	Mill		Box	100/pcs	\$376.56
MSFG36X100-L00	36" x 100' Char Fiber Mesh	Charcoal	100'	Roll	400 ft <sup>2</sup>	\$184.80
SPFRD130-BX-L	Foam Spline	Black	8,000'	Box	8,000'	\$506.88

\*\*Available in bulk quantities

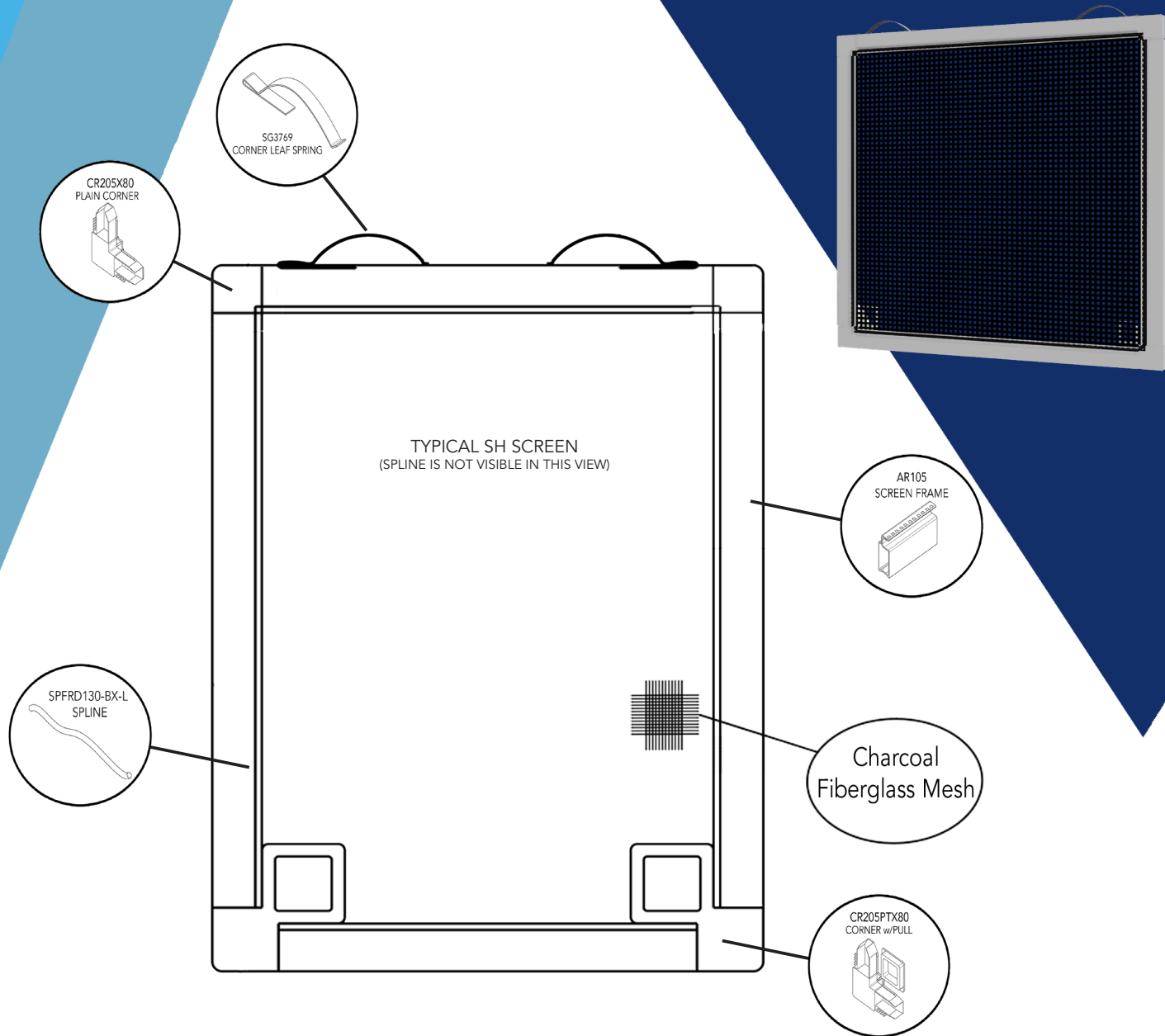

### Standard Colors:

XXX in part numbers are place holders for Color Code

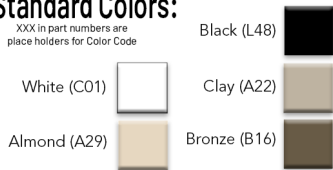

Shown in  $\frac{5}{16}$ ". Also available in  $\frac{3}{8}$ " and  $\frac{7}{16}$ ", contact RiteScreen for details.

Series #	Fully Assembled Screen	Size	UOM	List Price
RFSH2	Minimum Price	0" to 49" UI	United Inch	\$22.58
RFSH2	U.I. Price	50" UI and Above	United Inch	\$0.4608
RFSH2-W	With Woolpile	50" UI and Above	United Inch	\$0.5174

Part #	Description	Color	Length	UOM	QTY	List Price
AR105-16-12XXX	Screen Frame	Standard	12.5'	Box	152/pcs	\$1,583.72
XCR205X80-XXX**	Plain Corner	Standard		Box	100/pcs	\$87.30
XCR205PTX80-XXX**	Corner w/Pull	Standard		Box	100/pcs	\$98.39
XSG3769**	Leaf Spring	Mill		Box	100/pcs	\$376.56
MSFG36X100-L00	36" x 100' Char Fiber Mesh	Charcoal	100'	Roll	400 ft <sup>2</sup>	\$184.80
SPFRD130-BX-L	Foam Spline	Black	8,000'	Box	8,000'	\$506.88

\*\*Available in bulk quantities

# RFSH3 - Roll-Formed Single Hung Screen

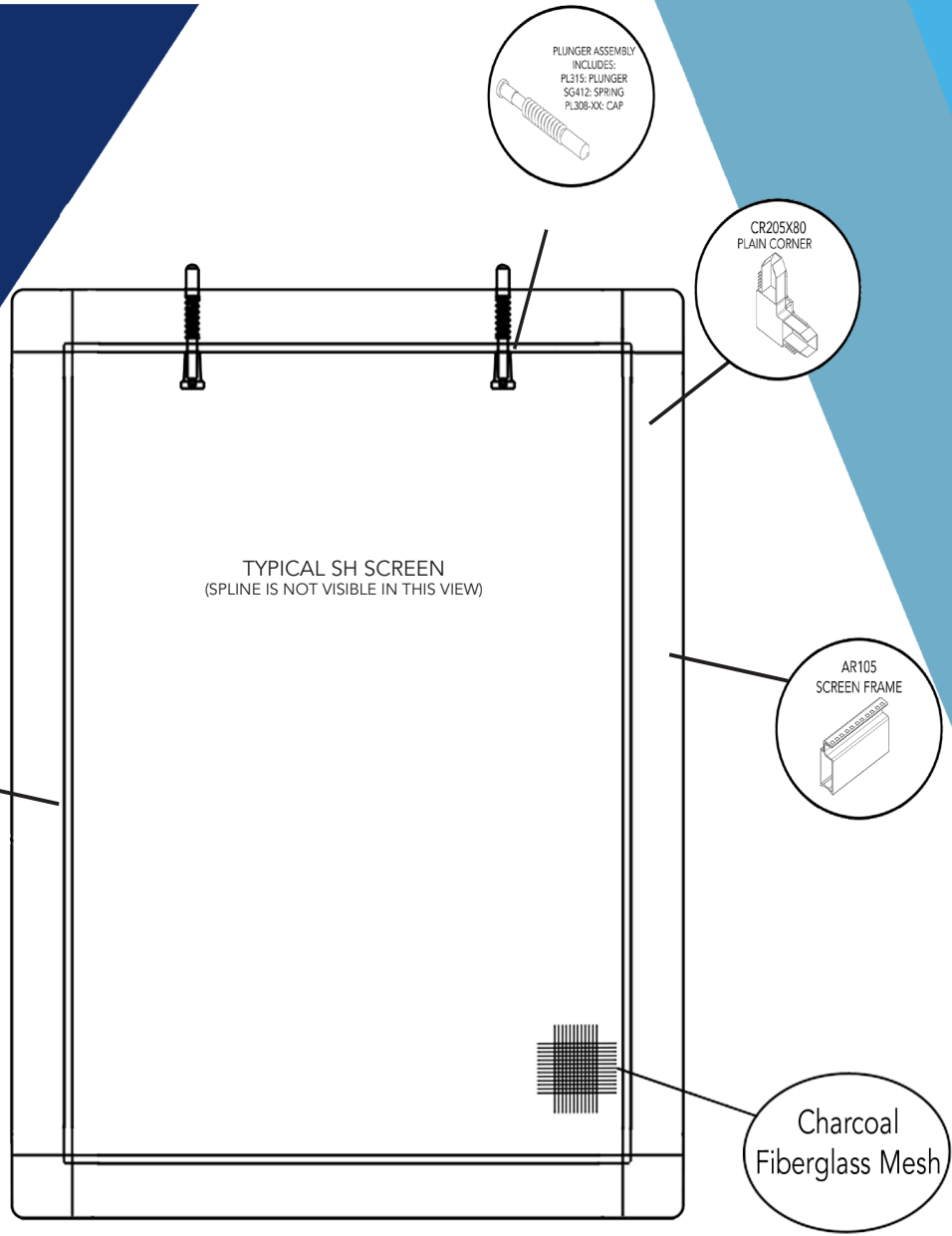
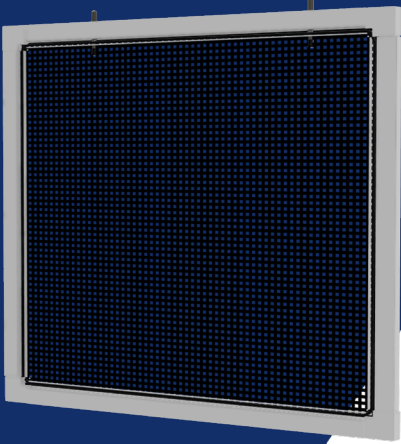

Shown in  $\frac{5}{16}$ ". Also available in  $\frac{3}{8}$ " and  $\frac{7}{16}$ ". contact RiteScreen for details.

### Standard Colors:

XXX in part numbers are place holders for Color Code

White (C01)		Clay (A22)	
Almond (A29)		Bronze (B16)	
		Black (L48)	

Series #	Fully Assembled Screen	Size	UOM	List Price
RFSH3	Minimum Price	0" to 49" UI	United Inch	\$22.96
RFSH3	U.I. Price	50" UI and Above	United Inch	\$0.4688
RFSH3-W	With Woolpile	50" UI and Above	United Inch	\$0.5254



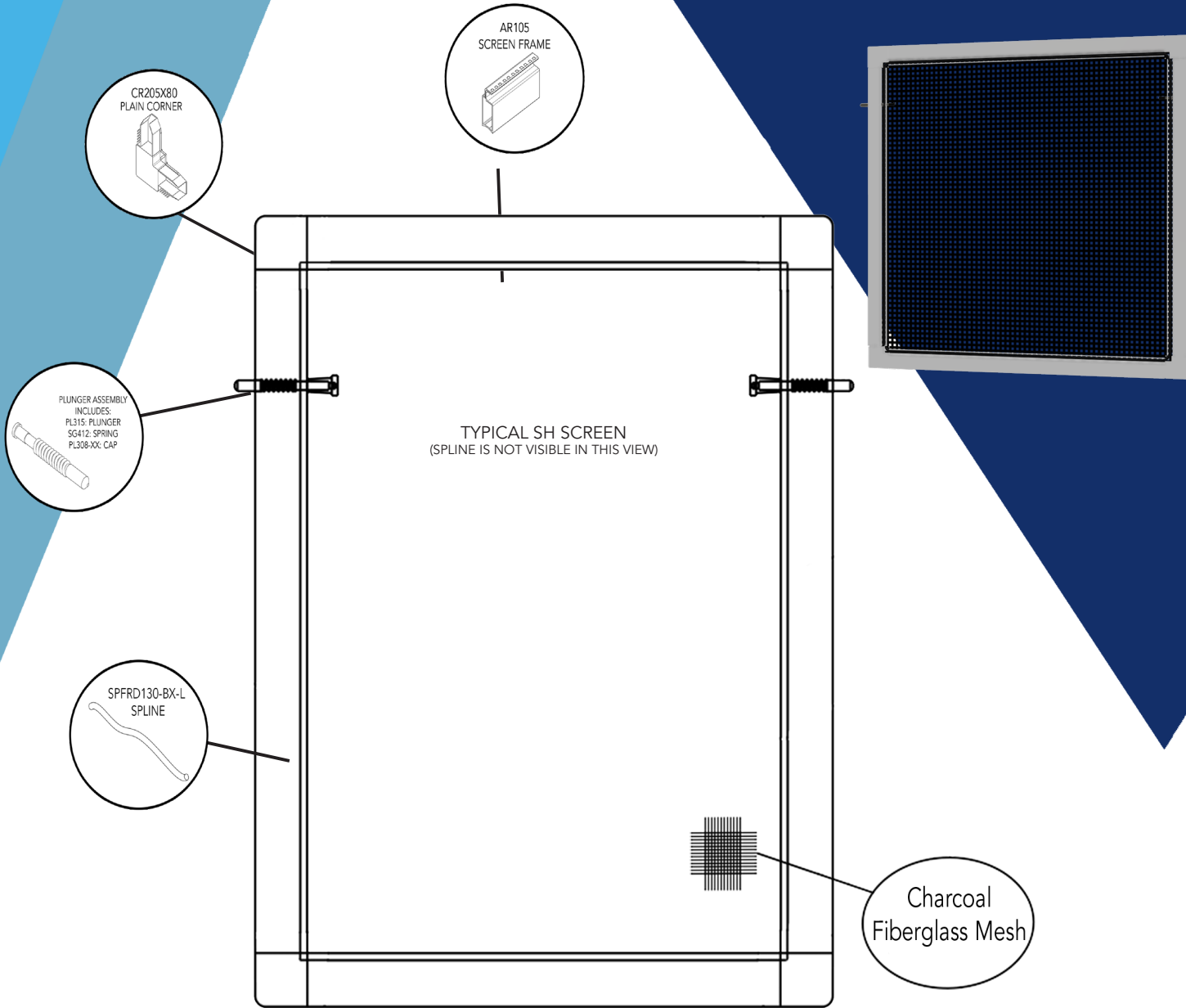

Part #	Description	Color	Length	UOM	QTY	List Price
AR105-16-12XXX	Screen Frame	Standard	12.5'	Box	152/pcs	\$1,583.72
XCR205X80-XXX**	Plain Corner	Standard		Box	100/pcs	\$87.30
XPL315**	Plunger	Mill		Box	100/pcs	\$93.20
XSG412**	Plunger Spring	Mill		Bag	100/pcs	\$115.20
XPL308-XXX**	Plunger Cap	Standard		Box	100/pcs	\$75.51
SPFRD130-BX-L	Foam Spline	Black	8,000'	Box	8,000'	\$506.88
MSPG36X100-L00	36" x 100' Char Fiber Mesh	Charcoal	100'	Roll	400 ft <sup>2</sup>	\$184.80

\*\*Available in bulk quantities



### Standard Colors:

XXX in part numbers are place holders for Color Code

Black (L48)	
White (C01)	
Almond (A29)	
Clay (A22)	
Bronze (B16)	

Shown in  $\frac{5}{16}$ ". Also available in  $\frac{3}{8}$ " and  $\frac{7}{16}$ ", contact RiteScreen for details.

Series #	Fully Assembled Screen	Size	UOM	List Price
RFSH4	Minimum Price	0" to 49" UI	United Inch	\$22.96
RFSH4	U.I. Price	50" UI and Above	United Inch	\$0.4688
RFSH4-W	With Woolpile	50" UI and Above	United Inch	\$0.5254

Part #	Description	Color	Length	UOM	QTY	List Price
AR105-16-12XXX	Screen Frame	Standard	12.5'	Box	152/pcs	\$1,583.72
XCR205X80-XXX**	Plain Corner	Standard		Box	100/pcs	\$87.30
XPL315**	Plunger	Mill		Box	100/pcs	\$93.20
XSG412**	Plunger Spring	Mill		Bag	100/pcs	\$115.20
XPL308-XXX**	Plunger Cap	Standard		Box	100/pcs	\$75.51
SPFRD130-BX-L	Foam Spline	Black	8,000'	Box	8,000'	\$506.88
MSFG36X100-L00	36" x 100' Char Fiber Mesh	Charcoal	100'	Roll	400 ft <sup>2</sup>	\$184.80

\*\*Available in bulk quantities

# RFSH5 - Roll-Formed Single Hung Screen

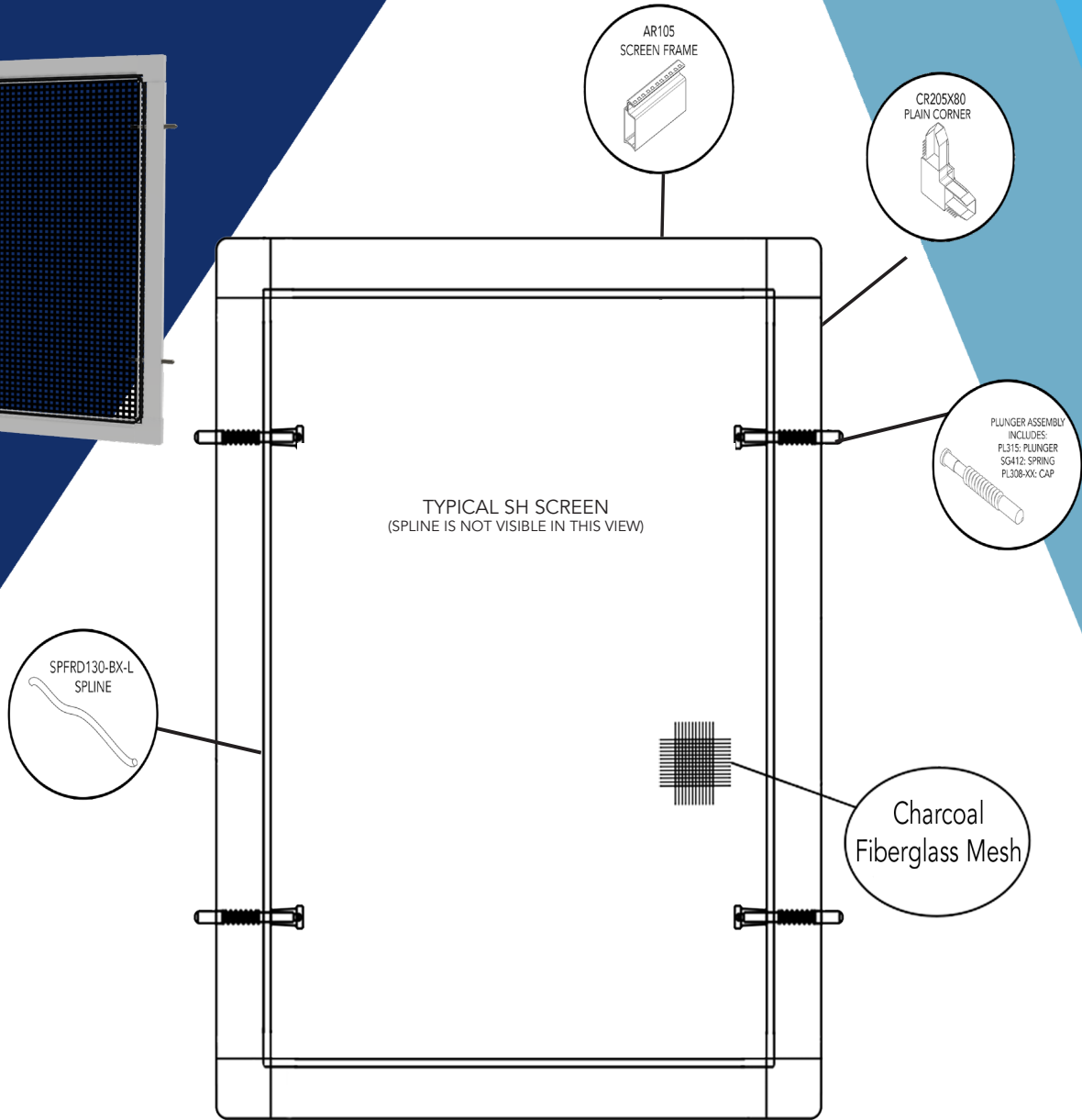
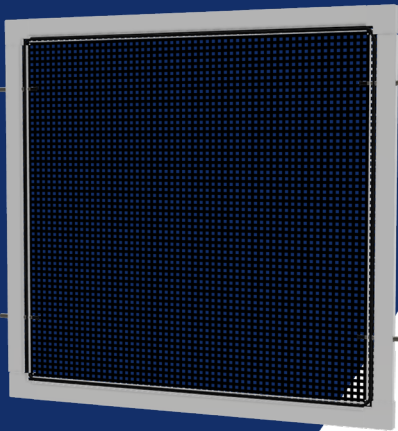

Shown in  $\frac{5}{16}$ ". Also available in  $\frac{3}{8}$ " and  $\frac{7}{16}$ ", contact RiteScreen for details.

### Standard Colors:

XXX in part numbers are place holders for Color Code

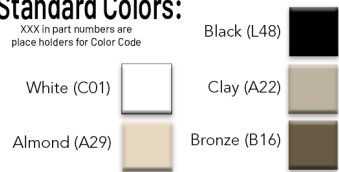

Series #	Fully Assembled Screen	Size	UOM	List Price
RFSH5	Minimum Price	0" to 49" UI	United Inch	\$23.90
RFSH5	U.I. Price	50" UI and Above	United Inch	\$0.4878

Part #	Description	Color	Length	UOM	QTY	List Price
AR105-16-12XXX	Screen Frame	Standard	12.5'	Box	152/pcs	\$1,583.72
XCR205X80-XXX**	Plain Corner	Standard		Box	100/pcs	\$87.30
XPL315**	Plunger	Mill		Box	100/pcs	\$93.20
XSG412**	Plunger Spring	Mill		Bag	100/pcs	\$115.20
XPL308-XXX**	Plunger Cap	Standard		Box	100/pcs	\$75.51
SPFRD130-BX-L	Foam Spline	Black	8,000'	Box	8,000'	\$506.88
MSFG36X100-L00	36" x 100' Char Fiber Mesh	Charcoal	100'	Roll	400 ft <sup>2</sup>	\$184.80

\*\* Available in bulk quantities

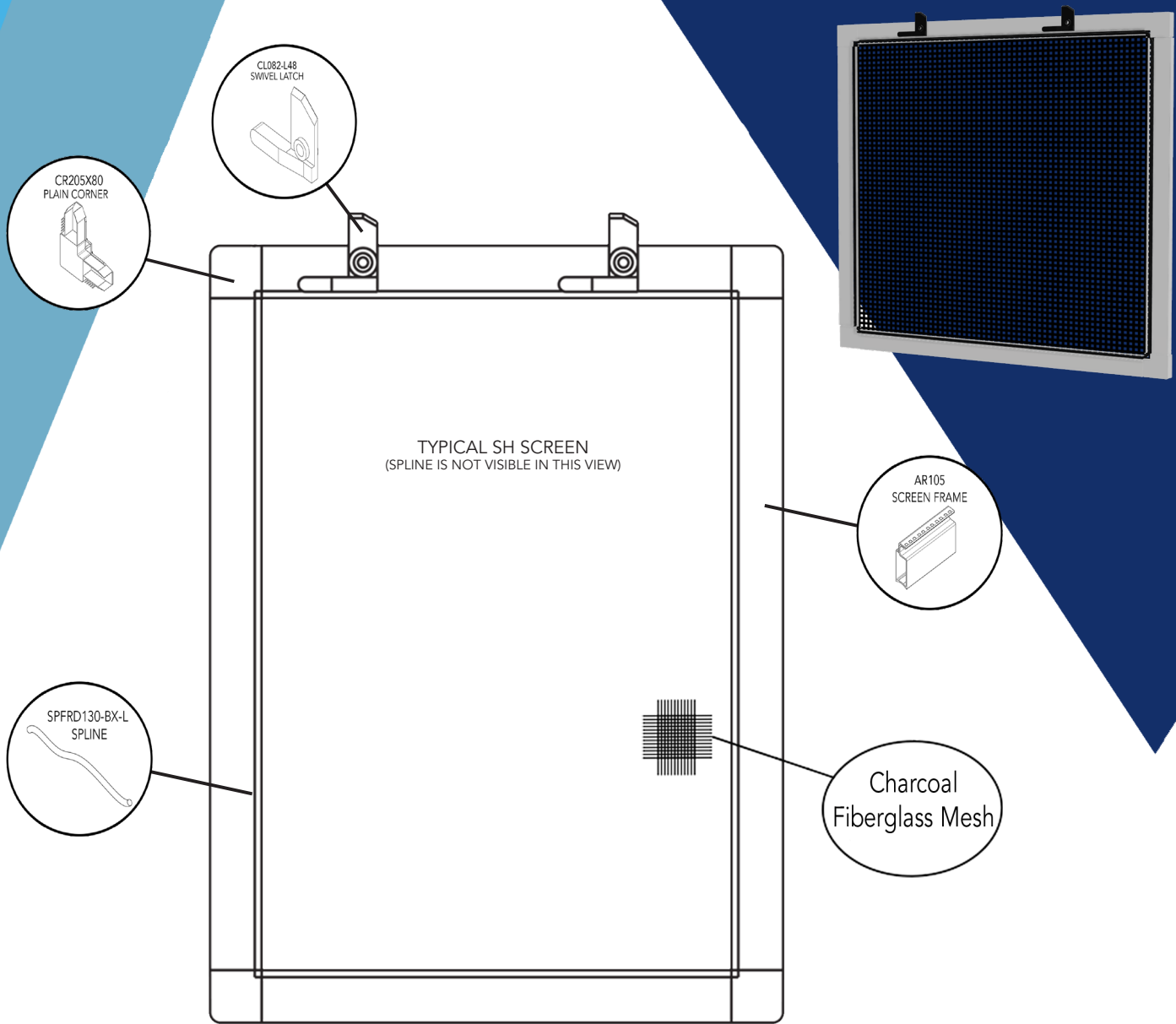

### Standard Colors:

XXX in part numbers are place holders for Color Code

Black (L48)	
White (C01)	
Almond (A29)	
Clay (A22)	
Bronze (B16)	

Shown in  $\frac{5}{16}$ ". Also available in  $\frac{3}{8}$ " and  $\frac{7}{16}$ ", contact RiteScreen for details.

Series #	Fully Assembled Screen	Size	UOM	List Price
RFSH6	Minimum Price	0" to 49" UI	United Inch	\$22.72
RFSH6	U.I. Price	50" UI and Above	United Inch	\$0.4634

Part #	Description	Color	Length	UOM	QTY	List Price
AR105-16-12XXX	Screen Frame	Standard	12.5'	Box	152/pcs	\$1,583.72
XCR205X80-XXX**	Plain Corner	Standard		Box	100/pcs	\$87.30
XCL082-L48**	Swivel Latch	Black		Box	100/pcs	\$98.57
SPFRD130-BX-L	Foam Spline	Black	8,000'	Box	8,000'	\$506.88
MSFG36X100-L00	36" x 100' Char Fiber Mesh	Charcoal	100'	Roll	400 ft <sup>2</sup>	\$184.80

\*\*Available in bulk quantities

# RFSH7 - Roll-Formed Single Hung Screen

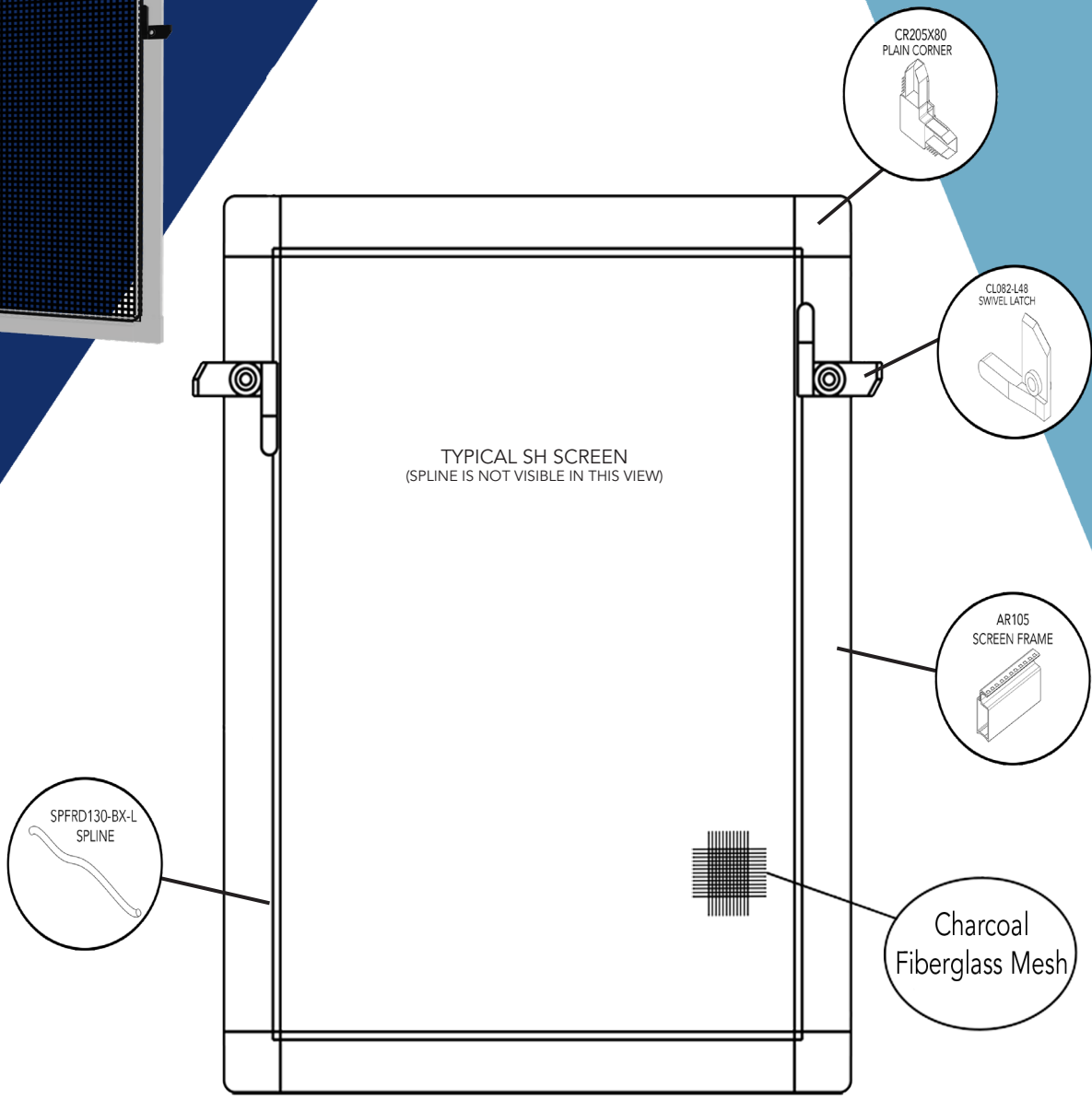
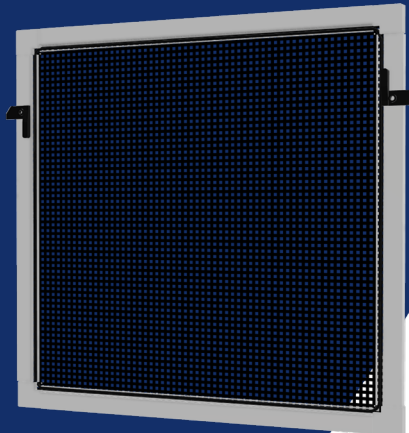

Shown in  $\frac{5}{16}$ ". Also available in  $\frac{3}{8}$ " and  $\frac{7}{16}$ ", contact RiteScreen for details.

### Standard Colors:



Series #	Fully Assembled Screen	Size	UOM	List Price
RFSH7	Minimum Price	0" to 49" UI	United Inch	\$22.72
RFSH7	U.I. Price	50" UI and Above	United Inch	\$0.4634

Part #	Description	Color	Length	UOM	QTY	List Price
AR105-16-12XXX	Screen Frame	Standard	12.5'	Box	152/pcs	\$1,583.72
XCR205X80-XXX**	Plain Corner	Standard		Box	100/pcs	\$87.30
XCL082-L48**	Swivel Latch	Black		Box	100/pcs	\$98.57
SPFRD130-BX-L	Foam Spline	Black	8,000'	Box	8,000'	\$506.88
MSFG36X100-L00	36" x 100' Char Fiber Mesh	Charcoal	100'	Roll	400 ft <sup>2</sup>	\$184.80

\*\*Available in bulk quantities

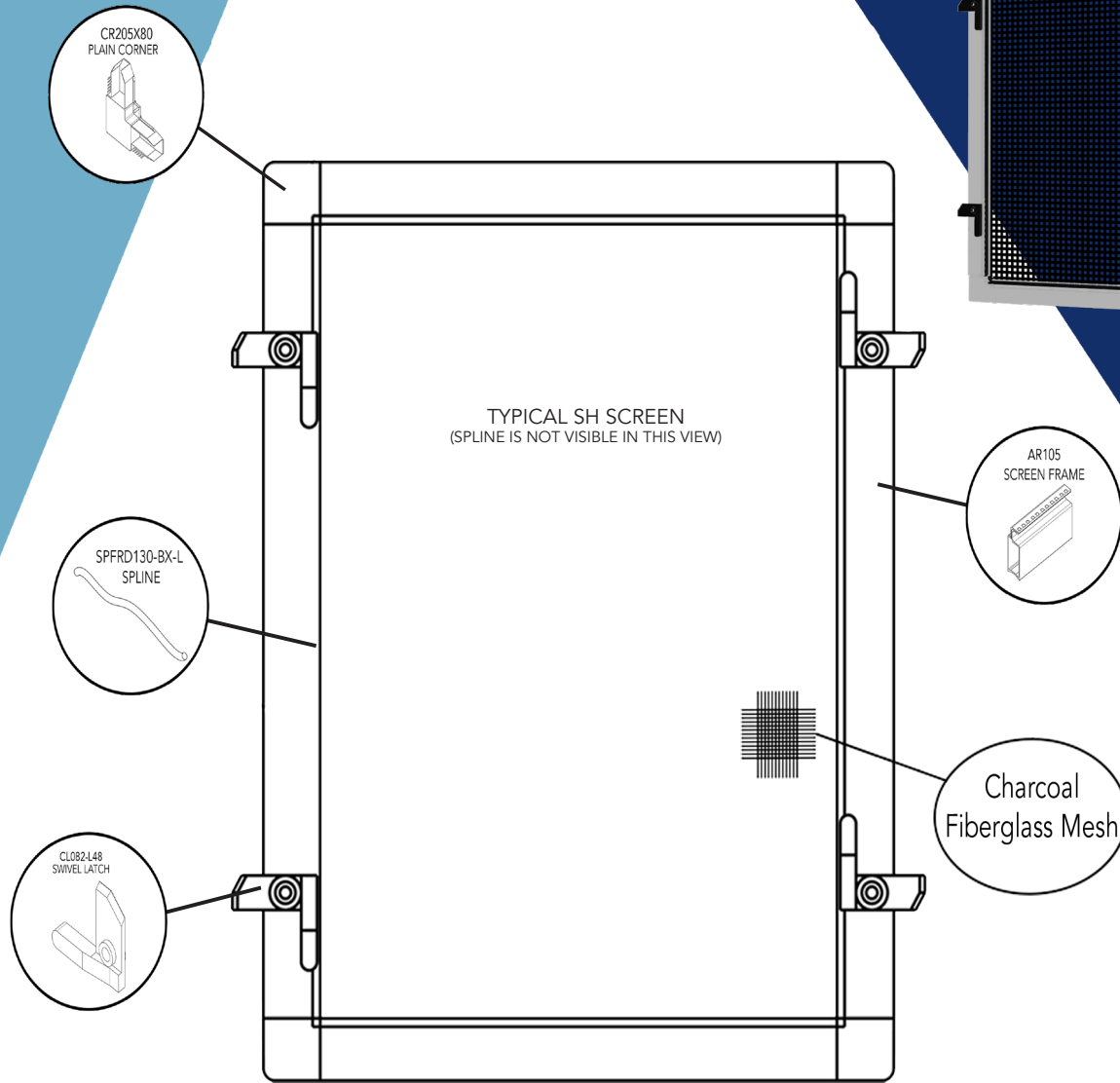

### Standard Colors:

XXX in part numbers are place holders for Color Code

Black (L48)	
White (C01)	
Almond (A29)	
Clay (A22)	
Bronze (B16)	

Shown in  $\frac{5}{16}$ ". Also available in  $\frac{3}{8}$ " and  $\frac{7}{16}$ ", contact RiteScreen for details.

Series #	Fully Assembled Screen	Size	UOM	List Price
RFSH8	Minimum Price	0" to 49" UI	United Inch	\$23.38
RFSH8	U.I. Price	50" UI and Above	United Inch	\$0.4772

Part #	Description	Color	Length	UOM	QTY	List Price
AR105-16-12XXX	Screen Frame	Standard	12.5'	Box	152/pcs	\$1,583.72
XCR205X80-XXX**	Plain Corner	Standard		Box	100/pcs	\$87.30
XCL082-L48**	Swivel Latch	Black		Box	100/pcs	\$98.57
SPFRD130-BX-L	Foam Spline	Black	8,000'	Box	8,000'	\$506.88
MSFG36X100-L00	36" x 100' Char Fiber Mesh	Charcoal	100'	Roll	400 ft <sup>2</sup>	\$184.80

\*\*Available in bulk quantities



# RFSH9 - Roll-Formed Single Hung Screen

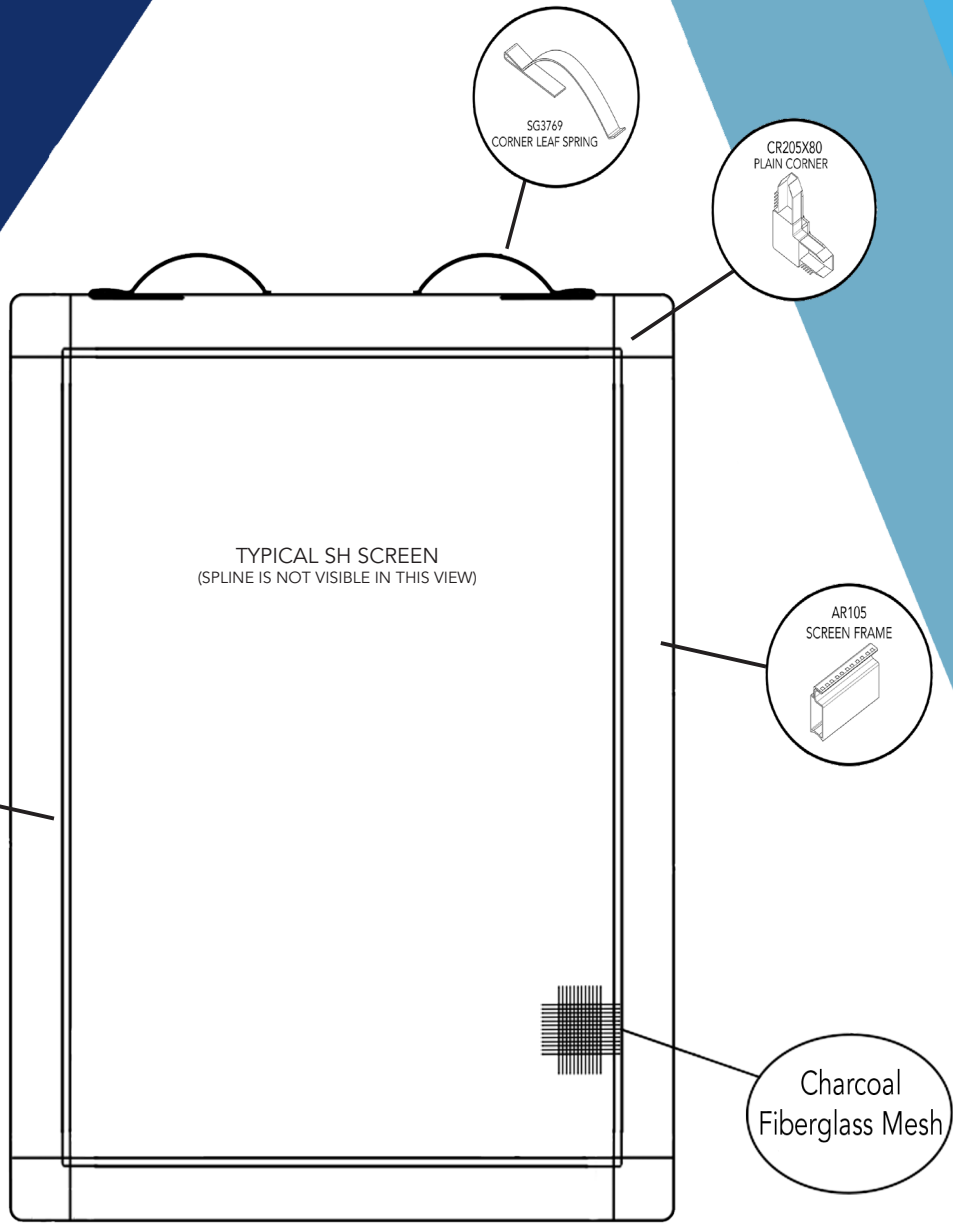
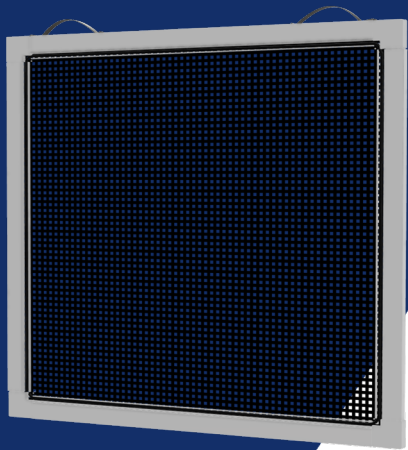

Shown in  $\frac{5}{16}$ ". Also available in  $\frac{3}{8}$ " and  $\frac{7}{16}$ ", contact RiteScreen for details.

### Standard Colors:

XXX in part numbers are place holders for Color Code



Series #	Fully Assembled Screen	Size	UOM	List Price
RFSH9	Minimum Price	0" to 49" UI	United Inch	\$22.58
RFSH9	U.I. Price	50" UI and Above	United Inch	\$0.4608



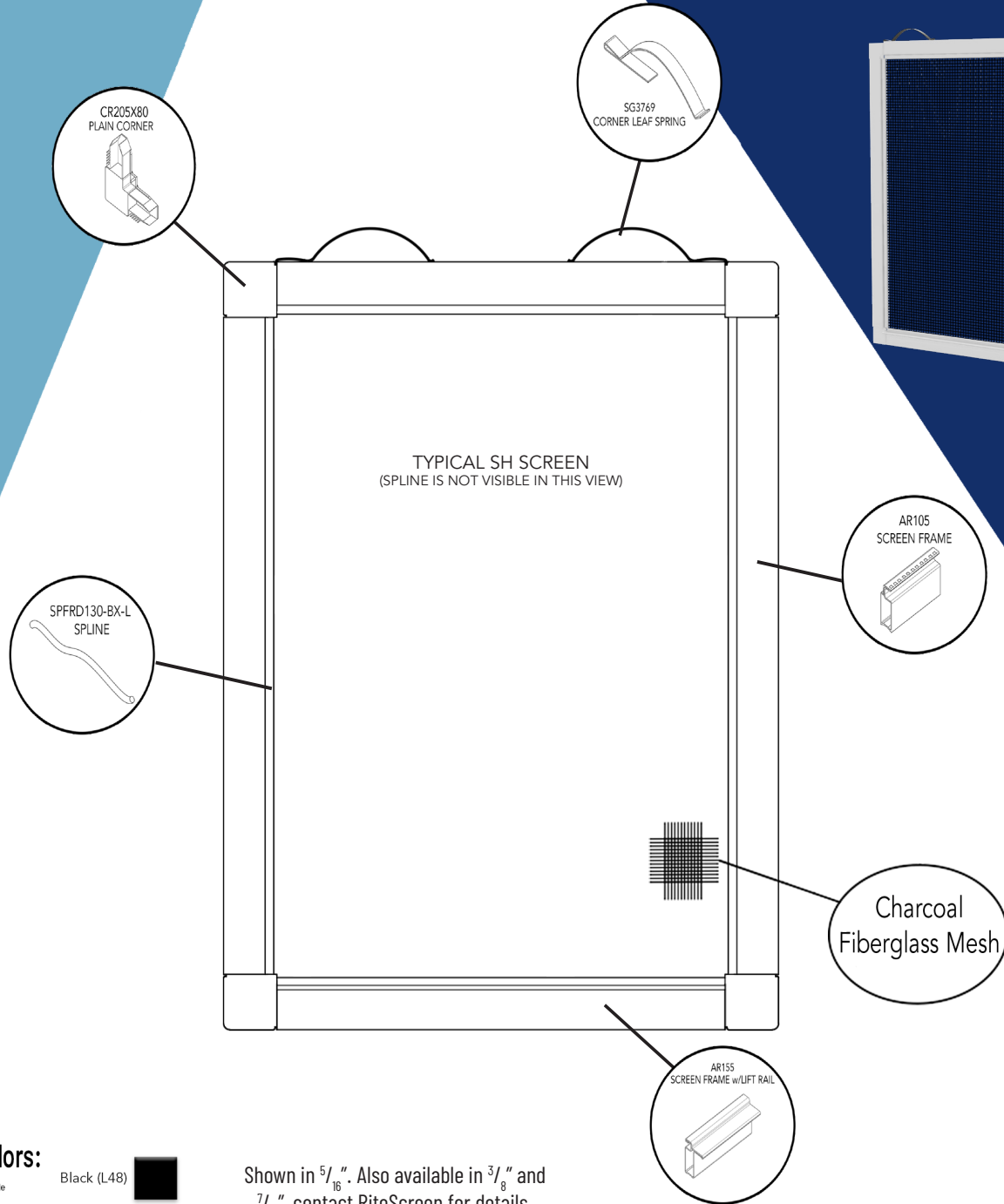

Part #	Description	Color	Length	UOM	QTY	List Price
AR105-16-12XXX	Screen Frame	Standard	12.5'	Box	152/pcs	\$1,583.72
XCR205X80-XXX**	Plain Corner	Standard		Box	100/pcs	\$87.30
XSG3769**	Leaf Spring	Mill		Box	100/pcs	\$376.56
MSFG36X100-L00	36" x 100' Char Fiber Mesh	Charcoal	100'	Roll	400 ft <sup>2</sup>	\$184.80
SPFRD130-BX-L	Foam Spline	Black	8,000'	Box	8,000'	\$506.88

\*\*Available in bulk quantities



### Standard Colors:

XXX in part numbers are  
placeholders for Color Code

Black (L48)	
White (C01)	
Almond (A29)	
Clay (A22)	
Bronze (B16)	

Shown in  $\frac{5}{16}$ ". Also available in  $\frac{3}{8}$ " and  $\frac{7}{16}$ ", contact RiteScreen for details.

Series #	Fully Assembled Screen	Size	UOM	List Price
RFSH10	Minimum Price	0" to 49" UI	United Inch	\$24.11
RFSH10	U.I. Price	50" UI and Above	United Inch	\$0.4920

Part #	Description	Color	Length	UOM	QTY	List Price
AR105-16-12XXX	Screen Frame	Standard	12.5'	Box	152/pcs	\$1,583.72
AR155-16-12XXX	Screen Frame	Standard	12.5'	Box	152/pcs	\$1,583.72
XCR205X80-XXX**	Plain Corner	Standard		Box	100/pcs	\$87.30
XSG3769	Leaf Spring	Mill		Box	100/pcs	\$376.56
SPFRD135-BX-L	Foam Spline	Black	8,000'	Box	8,000'	\$598.40
MMSG36X100-L00	36" x 100' Char Fiber Mesh	Charcoal	100'	Roll	400 ft <sup>2</sup>	\$184.80

\*\*Available in bulk quantities

# RFSH11 - Roll-Formed Single Hung Screen

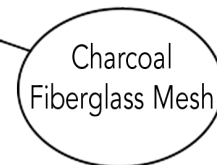
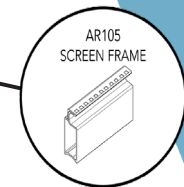
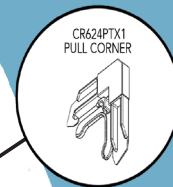
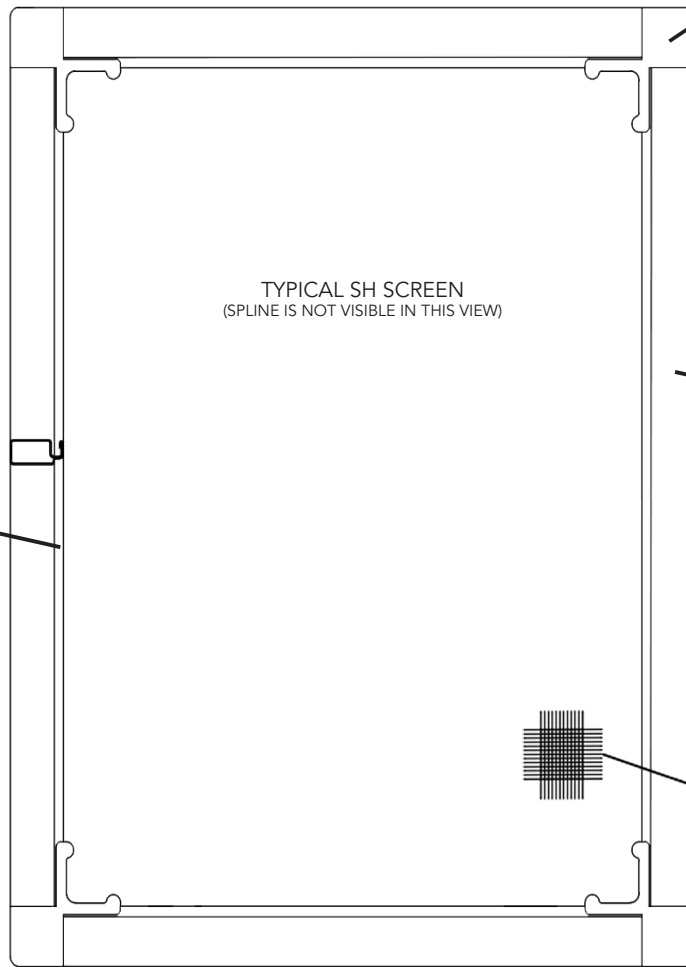
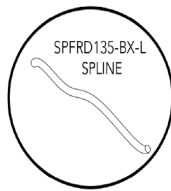
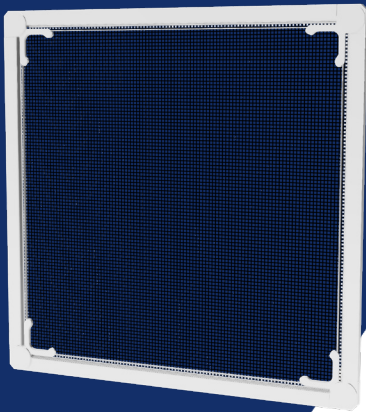

### Standard Colors:

XXX in part numbers are place holders for Color Code



Series #	Fully Assembled Screen	Size	UOM	List Price
RFSH11	Minimum Price	0" to 49" UI	United Inch	\$22.26
RFSH11	U.I. Price	50" UI and Above	United Inch	\$0.4543

Part #	Description	Color	Length	UOM	QTY	List Price
AR105-16-12XXX	Screen Frame	Standard	12.5'	Box	152/pcs	\$1,583.72
XCR624PTX1-XXX	Pull Tab Corner	Standard		Box	100/pcs	\$100.50
MSFG36X100-L00	36" x 100' Char Fiber Mesh	Charcoal	100'	Roll	400 ft <sup>2</sup>	\$184.80
SPFRD135-BX-L	Foam Spline	Black	8,000'	Box	8,000'	\$598.40

\*\*Available in bulk quantities

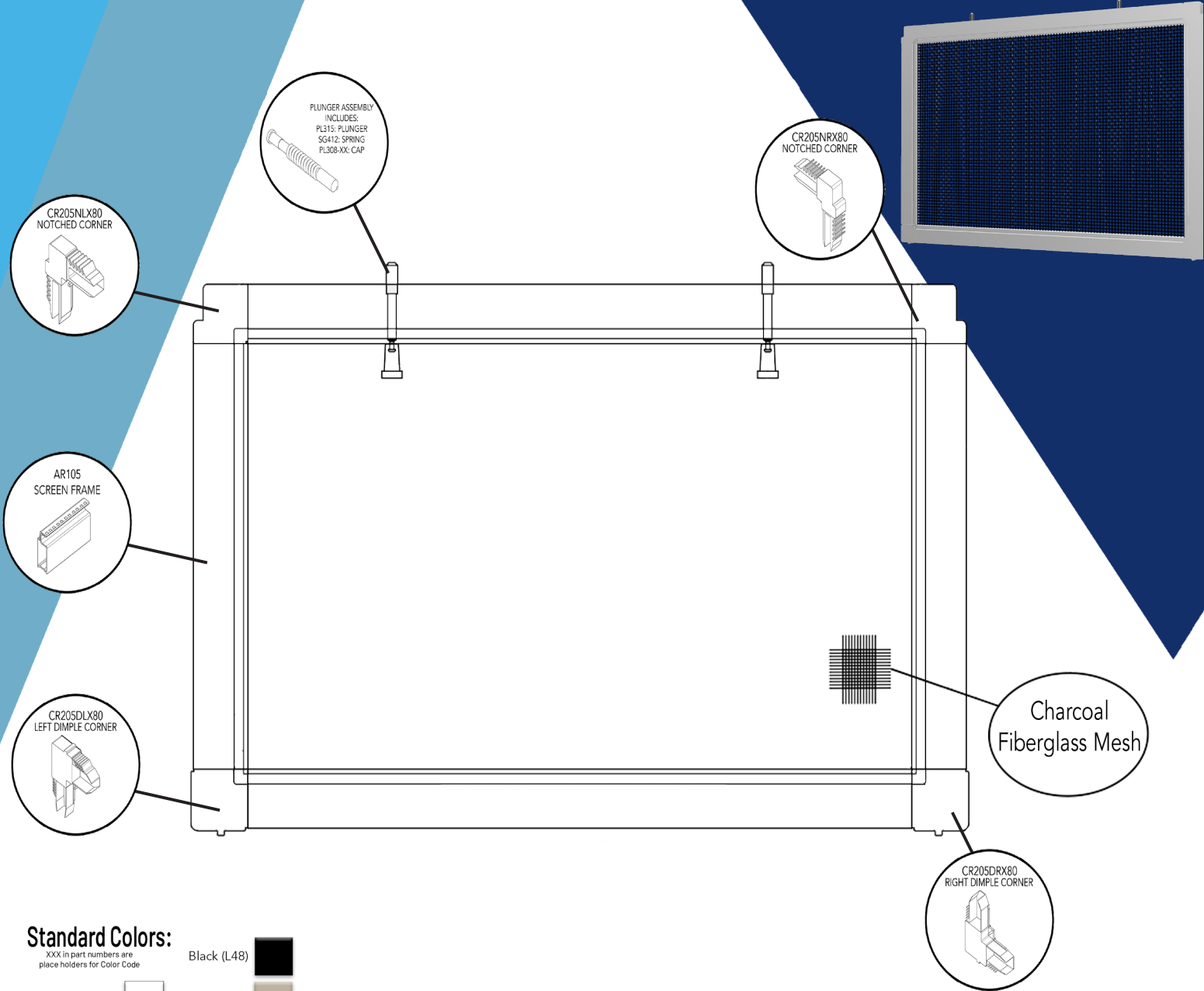

### Standard Colors:

XXX in part numbers are place holders for Color Code

White (C01)	Black (L48)		
Almond (A29)	Clay (A22)		
	Bronze (B16)		

Series #	Fully Assembled Screen	Size	UOM	List Price
RFSH12	Minimum Price	0" to 49" UI	United Inch	\$22.97
RFSH12	U.I. Price	50" UI and Above	United Inch	\$0.4688

Part #	Description	Color	Length	UOM	QTY	List Price
AR105-16-12XXX	Screen Frame	Standard	12.5'	Box	152/pcs	\$1,583.72
CR205DLX80-XXX / CR205DRX80-XXX	Dimple Corner	Standard		Box	100/pcs	\$87.30
CR205NLX80-XXX / CR205NRX80-XXX	Notched Corner	Standard		Box	100/pcs	\$87.30
XPL315**	Plunger	Mill		Box	100/pcs	\$93.20
XSG412**	Plunger Spring	Mill		Bag	100/pcs	\$115.20
XPL308-XXX**	Plunger Cap	Standard		Box	100/pcs	\$75.51
SPFRD135-BX-L	Foam Spline	Black	8,000'	Box	8,000'	\$369.60
MSFG36X100-L00	36" x 100' Char Fiber Mesh	Charcoal	100'	Roll	400 ft <sup>2</sup>	\$184.80

\*\*Available in bulk quantities

# RFDH1 - Roll-Formed Double Hung Screen

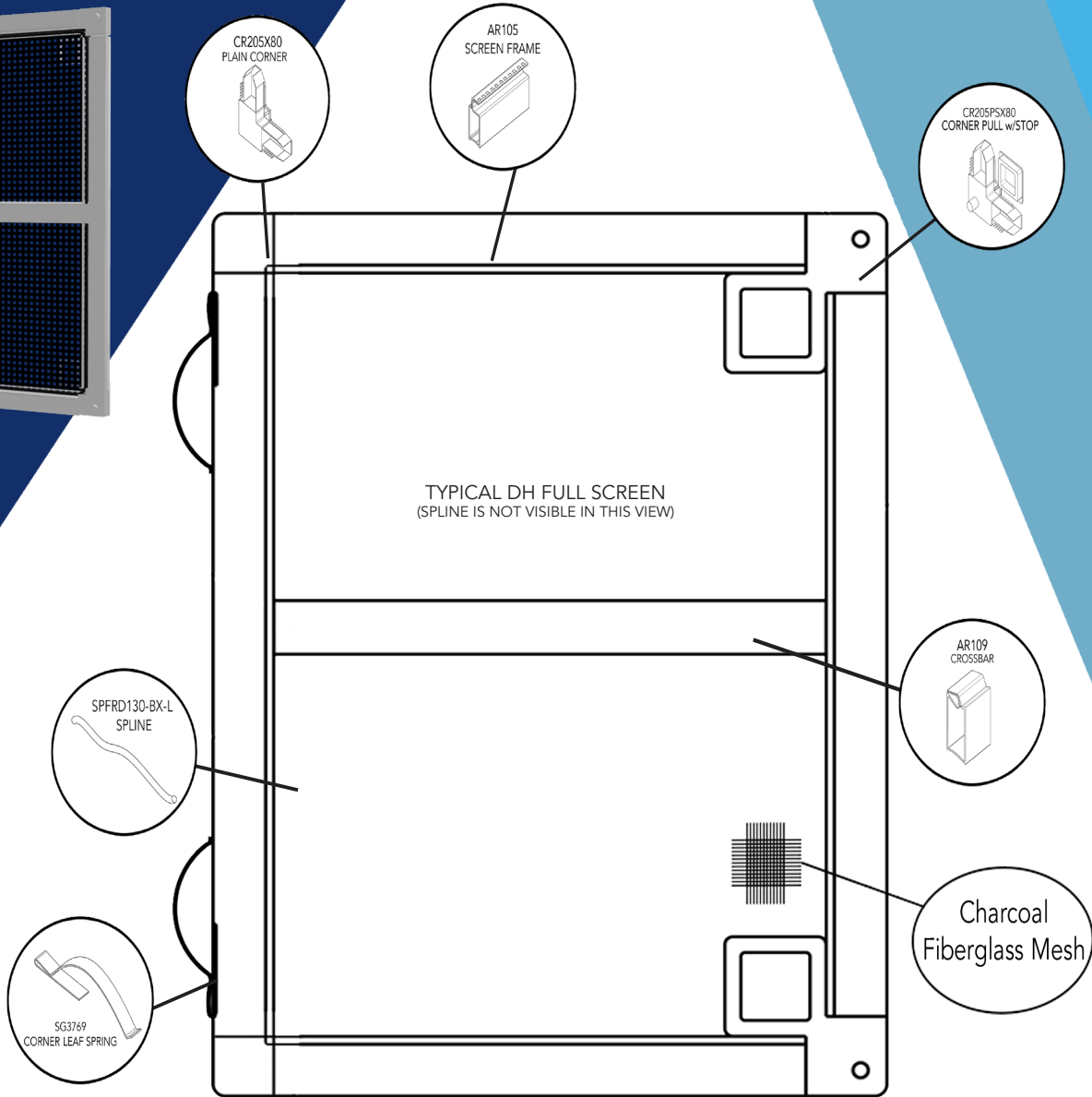
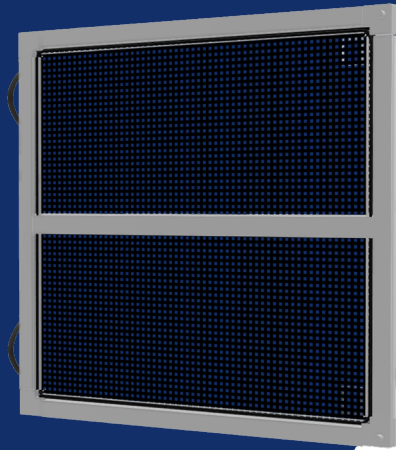

Shown in  $\frac{5}{16}$ ". Also available in  $\frac{3}{8}$ " and  $\frac{7}{16}$ ", contact RiteScreen for details.

### Standard Colors:

XXX in part numbers are place holders for Color Code

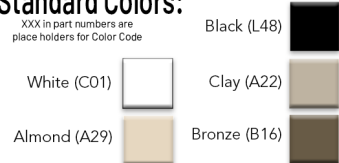

Series #	Fully Assembled Screen	Size	UOM	List Price
RFDH1	Minimum Price	0" to 49" UI	United Inch	\$21.78
RFDH1	U.I. Price	50" UI and Above	United Inch	\$0.4444



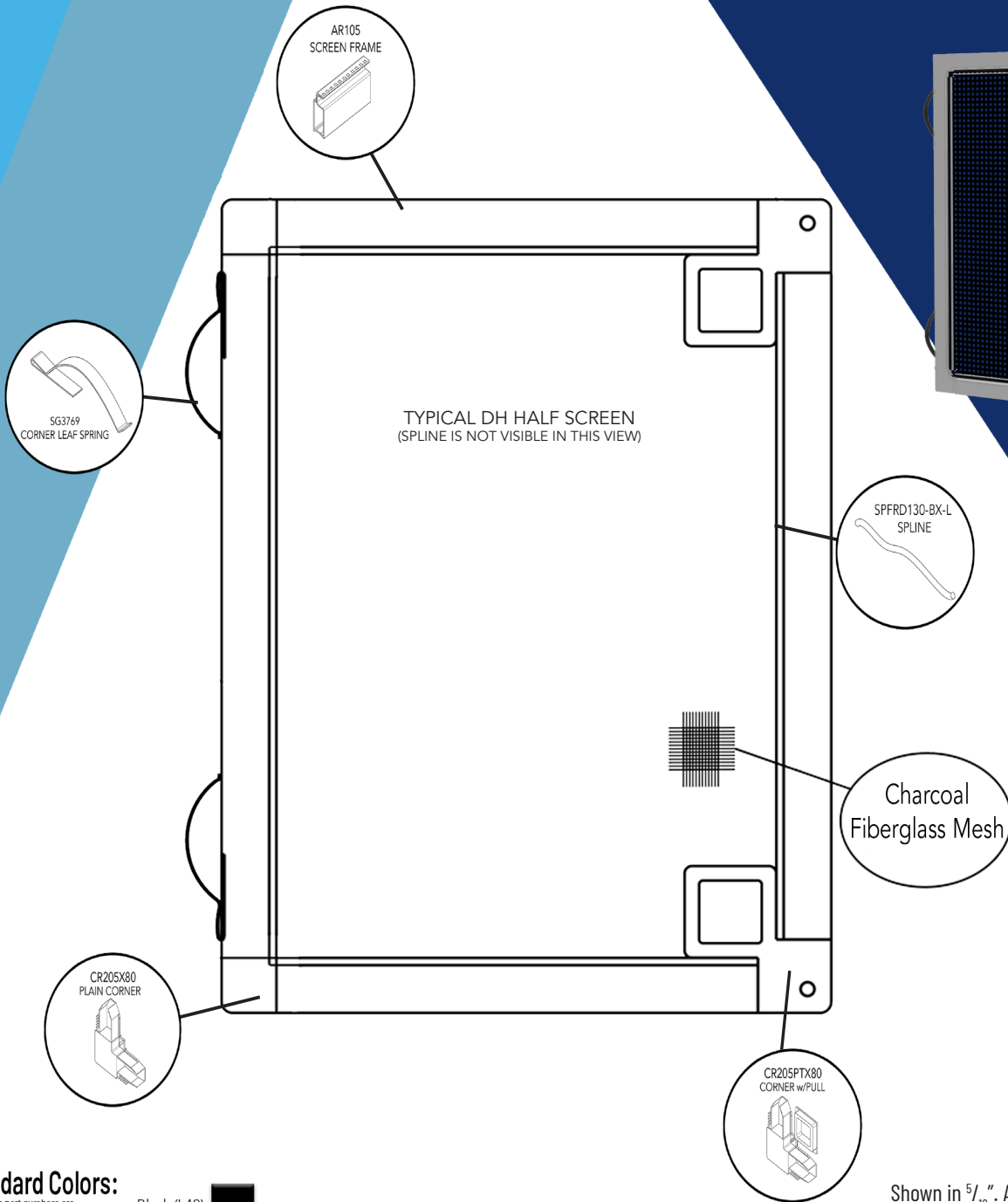

Part #	Description	Color	Length	UOM	QTY	List Price
AR105-16-12XXX	Screen Frame	Standard	12.5'	Box	152/pcs	\$1,583.72
AR109-16-11XXX	Crossbar	Standard	11.5'	Box	153/pcs	\$1,593.72
XCR205X80-XXX**	Plain Corner	Standard		Box	100/pcs	\$87.30
XCR205PSX80-XXX**	Corner Pull w/Stop	Standard		Box	100/pcs	\$98.39
XSG3769**	Leaf Spring	Mill		Box	100/pcs	\$376.56
MSFG36X100-L00	36" x 100' Char Fiber Mesh	Charcoal	100'	Roll	400 ft <sup>2</sup>	\$184.80
SPFRD130-BX-L	Foam Spline	Black	8,000'	Box	8,000'	\$506.88

\*\*Available in bulk quantities



### Standard Colors:

XXX in part numbers are place holders for Color Code

Black (L48)	
White (C01)	
Almond (A29)	
Clay (A22)	
Bronze (B16)	

Shown in  $\frac{5}{16}$ ". Also available in  $\frac{3}{8}$ " and  $\frac{7}{16}$ ", contact RiteScreen for details.

Series #	Fully Assembled Screen	Size	UOM	List Price
RFDH2	Minimum Price	0" to 49" UI	United Inch	\$22.58
RFDH2	U.I. Price	50" UI and Above	United Inch	\$0.4608

Part #	Description	Color	Length	UOM	QTY	List Price
AR105-16-12XXX	Screen Frame	Standard	12.5'	Box	152/pcs	\$1,583.72
XCR205X80-XXX**	Plain Corner	Standard		Box	100/pcs	\$87.30
XCR205PSX80-XXX**	Corner Pull w/Stop	Standard		Box	100/pcs	\$98.39
XSG3769**	Leaf Spring	Mill		Box	100/pcs	\$376.56
MSFG36X100-L00	36" x 100' Char Fiber Mesh	Charcoal	100'	Roll	400 ft <sup>2</sup>	\$184.80
SPFRD130-BX-L	Foam Spline	Black	8,000'	Box	8,000'	\$506.88

\*\*Available in bulk quantities

# RFDH3 - Roll-Formed Double Hung Half Screen

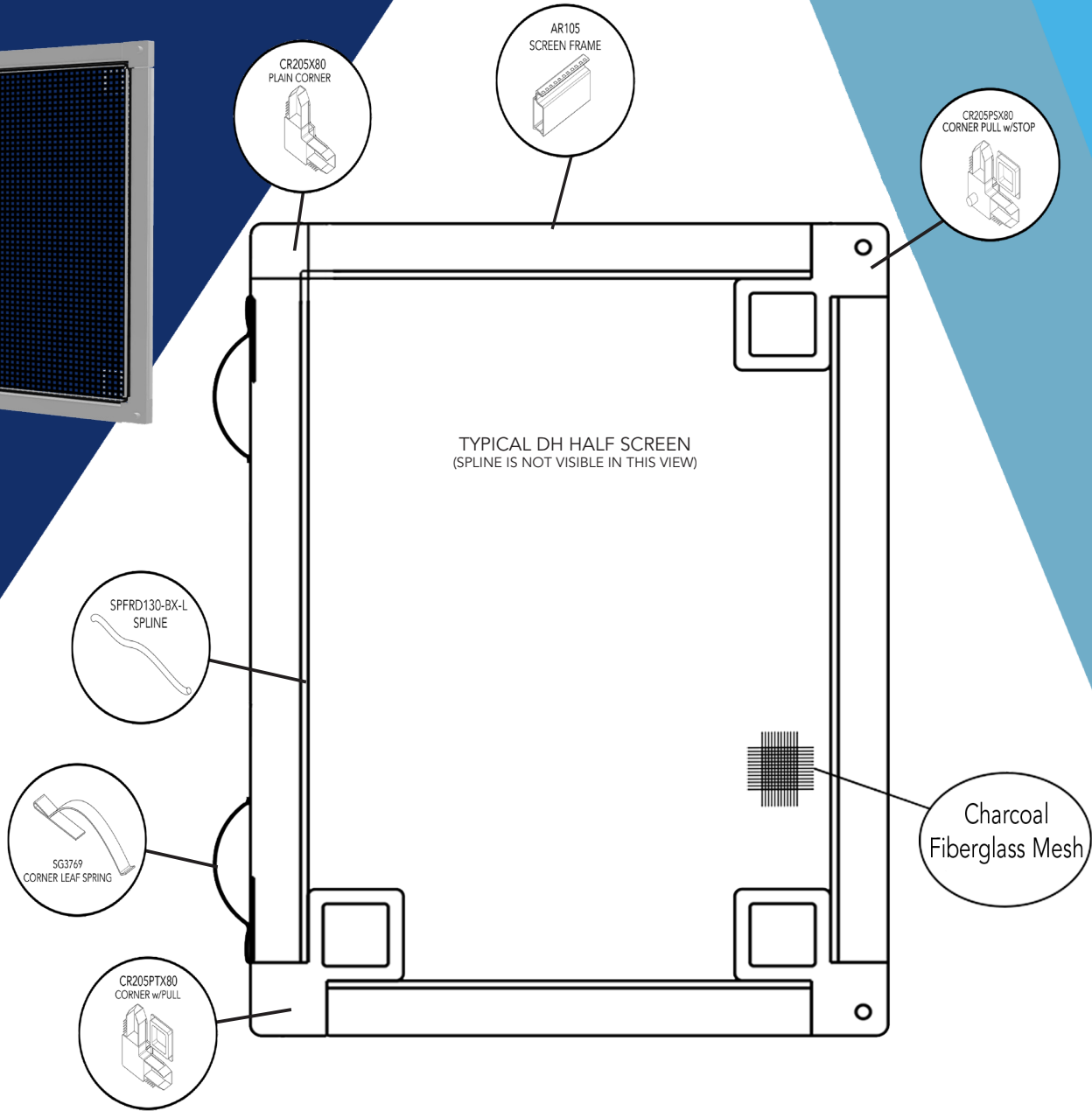
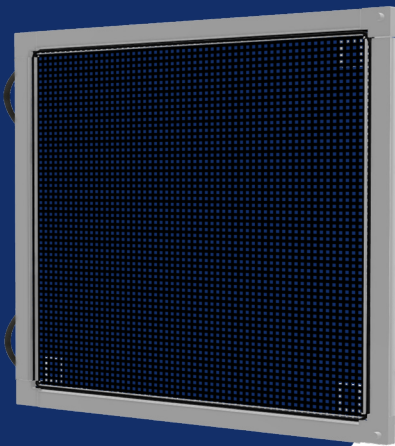

Shown in  $\frac{5}{16}$ ". Also available in  $\frac{3}{8}$ " and  $\frac{7}{16}$ ", contact RiteScreen for details.

### Standard Colors:

XXX in part numbers are place holders for Color Code

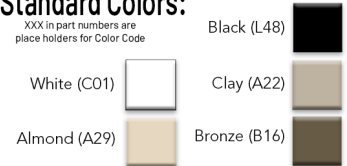

Series #	Fully Assembled Screen	Size	UOM	List Price
RFDH3	Minimum Price	0" to 49" UI	United Inch	\$22.58
RFDH3	U.I. Price	50" UI and Above	United Inch	\$0.4608

Part #	Description	Color	Length	UOM	QTY	List Price
AR105-16-12XXX	Screen Frame	Standard	12.5'	Box	152/pcs	\$1,583.72
XCR205PTX80-XXX**	Corner w/Pull	Standard		Box	100/pcs	\$98.39
XCR205X80-XXX**	Plain Corner	Standard		Box	100/pcs	\$87.30
XCR205PSX80-XXX**	Corner Pull w/Stop	Standard		Box	100/pcs	\$98.39
XSG3769**	Leaf Spring	Mill		Box	100/pcs	\$376.56
MSFG36X100-L00	36" x 100' Char Fiber Mesh	Charcoal	100'	Roll	400 ft <sup>2</sup>	\$184.80
SPFRD130-BX-L	Foam Spline	Black	8,000'	Box	8,000'	\$506.88

\*\*Available in bulk quantities

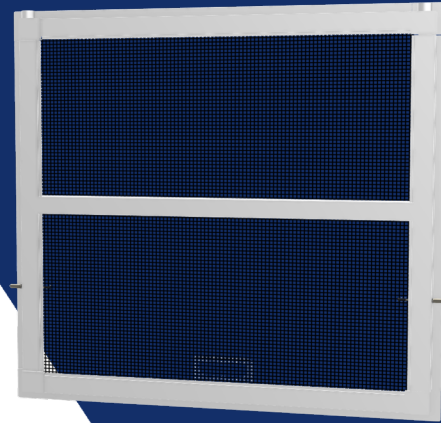
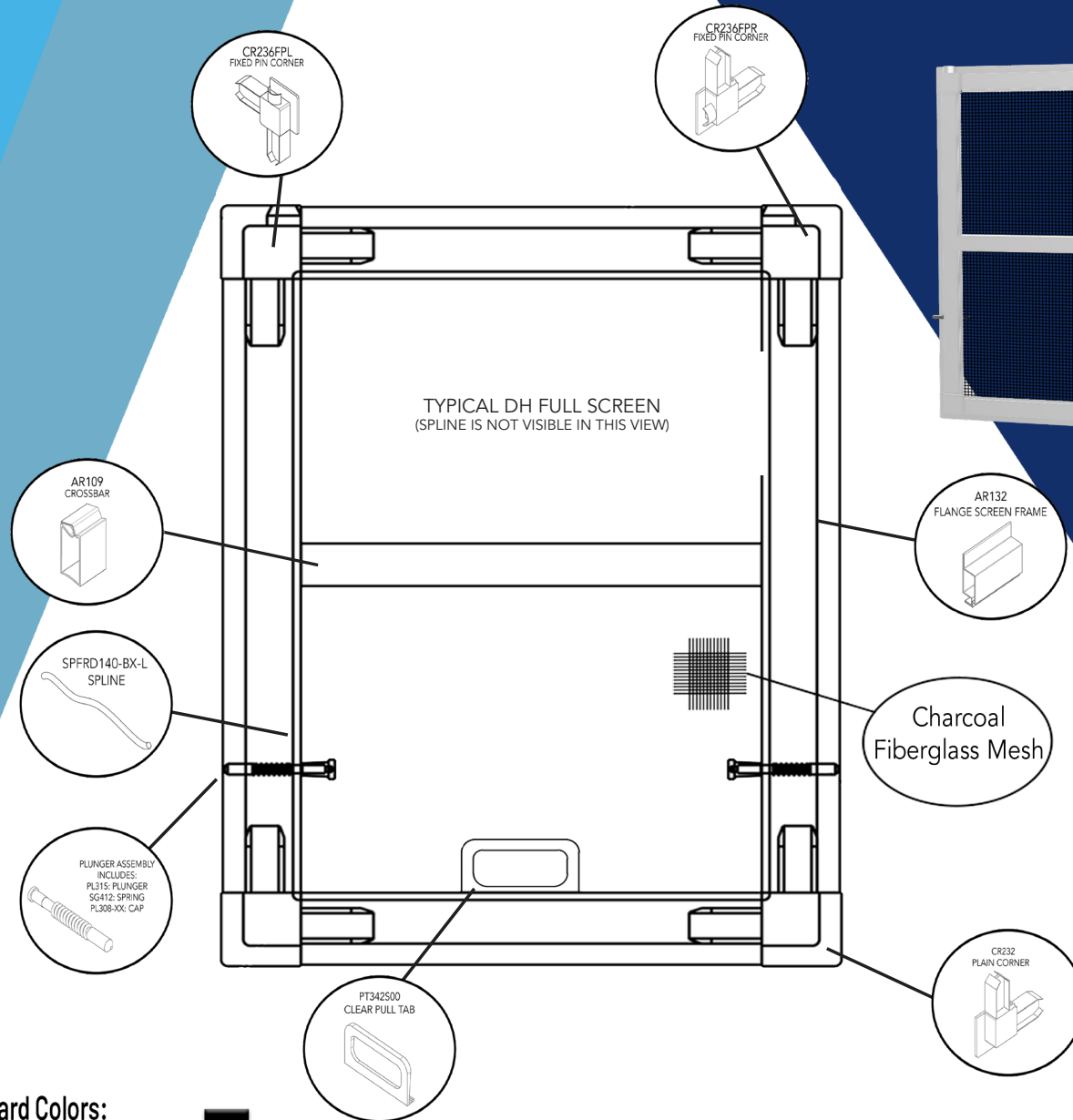

### Standard Colors:

XXX in part numbers are place holders for Color Code

Black (L48)	
White (C01)	
Almond (A29)	
Clay (A22)	
Bronze (B16)	

Shown in  $\frac{3}{8}$ "

Series #	Fully Assembled Screen	Size	UOM	List Price
RFDH4	Minimum Price	0" to 49" UI	United Inch	\$25.46
RFDH4	U.I. Price	50" UI and Above	United Inch	\$0.5194

Part #	Description	Color	Length	UOM	QTY	List Price
AR132-16-12XXX	Flange Screen Frame	Standard	12.5'	Box	105/pcs	\$1,484.36
AR109-16-11XXX	Crossbar	Standard	11.5'	Box	153/pcs	\$1,593.72
XCR232-XXX**	Plain Corner	Standard		Box	100/pcs	\$142.48
XCR236FPR/L-XXX**	Fixed Pin Corner	Standard		Box	100/pcs	\$187.18
XPT342S00**	Clear Pull Tab	Clear		Box	100/pcs	\$84.14
XPL315**	Plunger	Mill		Box	100/pcs	\$93.20
XSG412**	Plunger Spring	Mill		Bag	100/pcs	\$115.20
XPL308-XXX**	Plunger Cap	Standard		Box	100/pcs	\$75.51
MSFG36X100-L00	36" x 100' Char Fiber Mesh	Charcoal	100'	Roll	400 ft <sup>2</sup>	\$184.80
SPFRD140-BX-L	Foam Spline	Black	8,000'	Box	8,000'	\$612.48

\*\*Available in bulk quantities



# RFDH5 - Roll-Formed Double Hung Full Screen

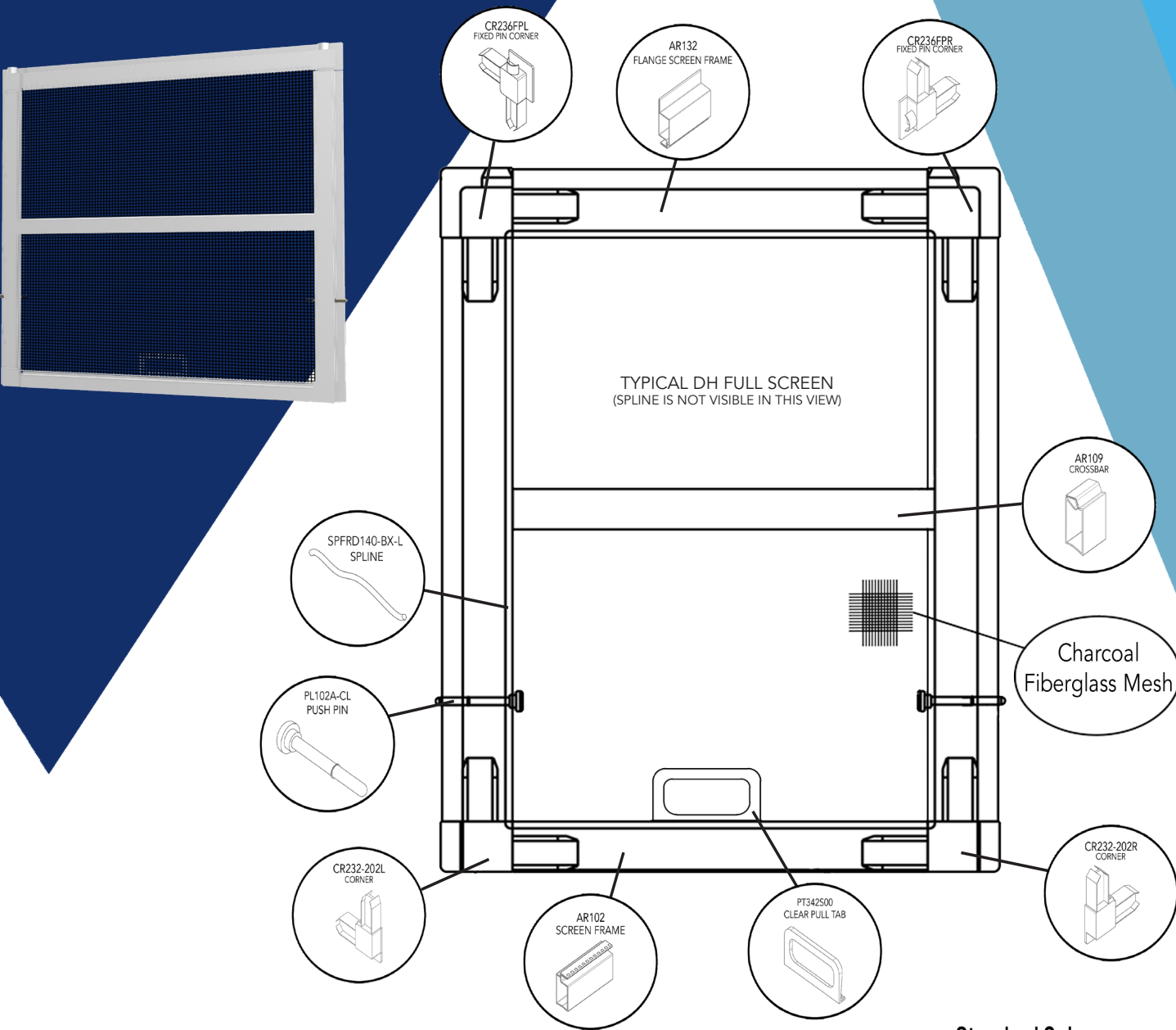

Shown in  $\frac{3}{8}$ "

### Standard Colors:

XXX in part numbers are place holders for Color Code



Series #	Fully Assembled Screen	Size	UOM	List Price
RFDH5	Minimum Price	0" to 49" UI	United Inch	\$24.98
RFDH5	U.I. Price	50" UI and Above	United Inch	\$0.5098

Part #	Description	Color	Length	UOM	QTY	List Price
AR132-16-12XXX	Flange Screen Frame	Standard	12.5'	Box	105/pcs	\$1,484.36
AR102-16-12XXX	Screen Frame	Standard	12.5'	Box	128/pcs	\$1,419.08
AR109-16-11XXX	Crossbar	Standard	11.5'	Box	153/pcs	\$1,593.72
XCR232-202R/L-XXX**	Corner	Standard		Bag	100/pcs	\$255.03
XCR236FPR/L-XX**	Fixed Pin Corner	Standard		Box	100/pcs	\$187.18
XPL1012A-CL	Push Pin	Mill		Box	100/pcs	\$86.16
XPT342S00**	Clear Pull Tab	Clear		Box	100/pcs	\$84.14
MSFG36X100-L00	36" x 100' Char Fiber Mesh	Charcoal	100'	Roll	400 ft <sup>2</sup>	\$184.80
SPFRD140-BX-L	Foam Spline	Black	8,000'	Box	8,000'	\$612.48

\*\*Available in bulk quantities

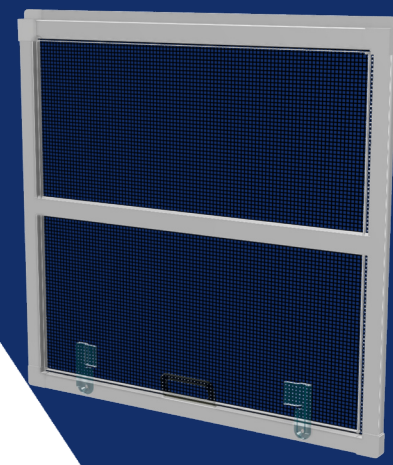
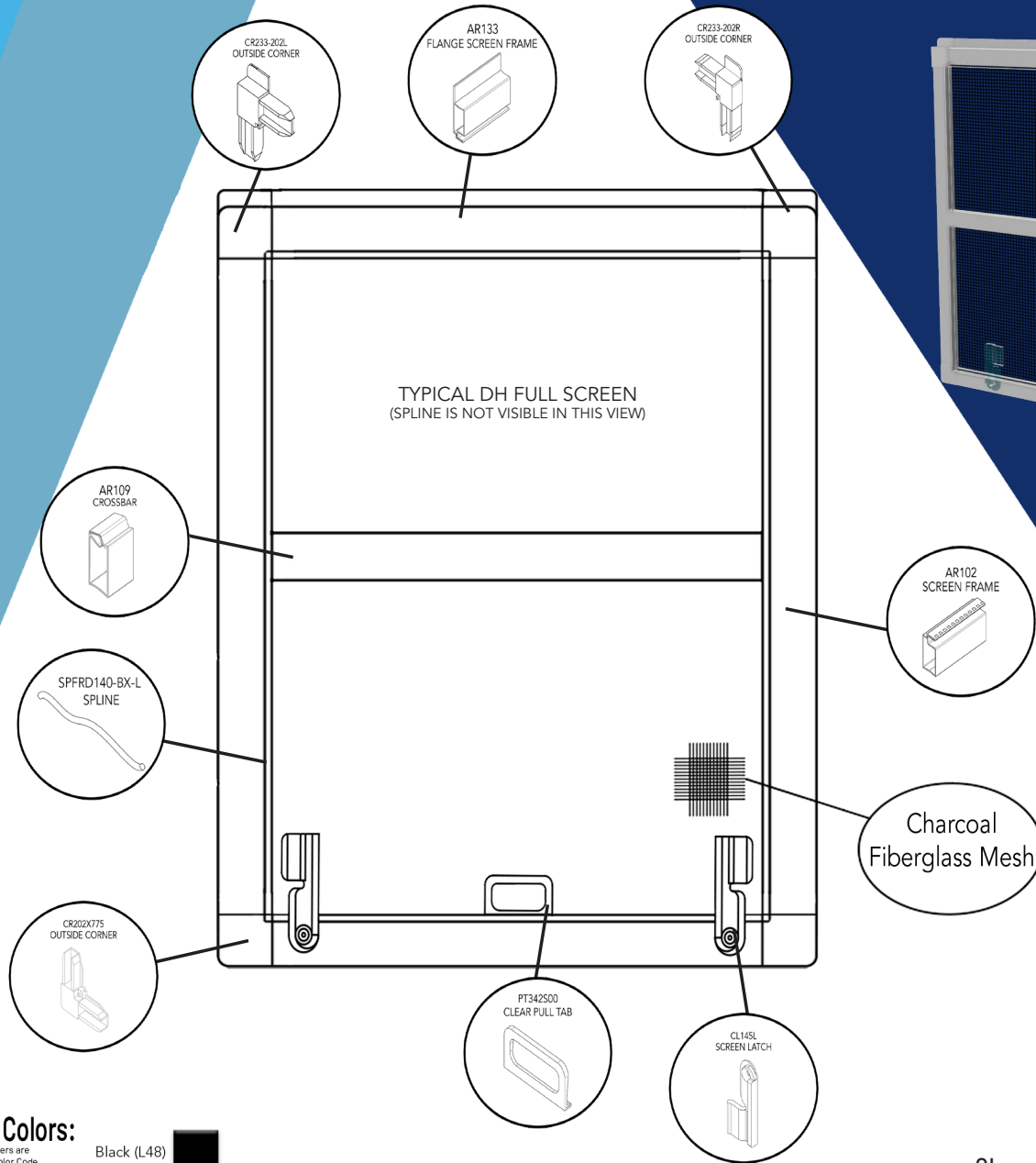

### Standard Colors:

XXX in part numbers are place holders for Color Code

Black (L48)	
White (C01)	
Almond (A29)	
Clay (A22)	
Bronze (B16)	

Shown in  $\frac{3}{8}$ "

Series #	Fully Assembled Screen	Size	UOM	List Price
RFDH6	Minimum Price	0" to 49" UI	United Inch	\$23.60
RFDH6	U.I. Price	50" UI and Above	United Inch	\$0.4818

Part #	Description	Color	Length	UOM	QTY	List Price
AR133-16-12XXX	Flange Screen Frame	Standard	12.5'	Box	105/pcs	\$1,525.52
AR102-16-12XXX	Screen Frame	Standard	12.5'	Box	128/pcs	\$1,419.08
AR109-16-11XXX	Crossbar	Standard	11.5'	Box	153/pcs	\$1,593.72
XCR233-202L/R**	Plain Corner	Standard		Box	100/pcs	\$255.03
XCR202X775-XXX**	Outside Corner	Standard		Box	100/pcs	\$209.80
XCL145L/R-S00**	Screen Latch	Clear		Box	100/pcs	\$114.94
XPT342S00**	Clear Pull Tab	Clear		Box	100/pcs	\$84.14
MSFG36X100-L00	36" x 100' Char Fiber Mesh	Charcoal	100'	Roll	400 ft <sup>2</sup>	\$184.80
SPFRD140-BX-L	Foam Spline	Black	8,000'	Box	8,000'	\$612.48

\*\*Available in bulk quantities

# RFDH7 - Roll-Formed Double Hung Full Screen

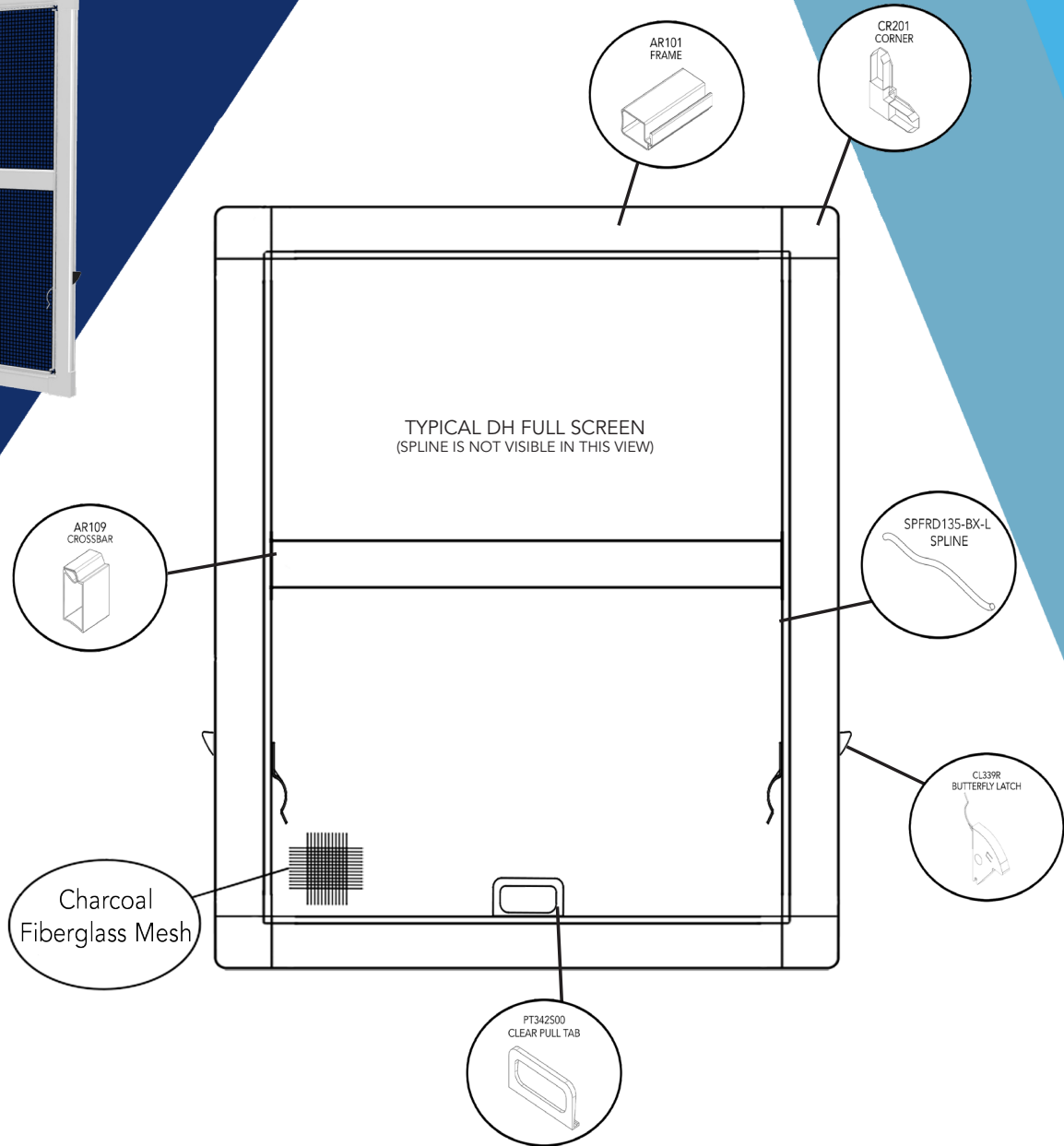

Shown in 7/16"

### Standard Colors:

XXX in part numbers are place holders for Color Code



Series #	Fully Assembled Screen	Size	UOM	List Price
RFDH7	Minimum Price	0" to 49" UI	United Inch	\$24.82
RFDH7	U.I. Price	50" UI and Above	United Inch	\$0.5064

Part #	Description	Color	Length	UOM	QTY	List Price
AR101-16-12XXX	Screen Frame	Standard	12.5'	Box	112/pcs	\$1,293.64
AR109-16-11XXX	Crossbar	Standard	11.5'	Box	153/pcs	\$1,593.72
XCR201-XXX**	Outside Corner	Standard		Box	100/pcs	\$174.69
XCL339R/L**	Butterfly Latch	Mill		Box	100/pcs	\$304.40
XPT342S00**	Clear Pull Tab	Clear		Box	100/pcs	\$84.14
MSFG36X100-L00	36" x 100' Char Fiber Mesh	Charcoal	100'	Roll	400 ft <sup>2</sup>	\$184.80
SPFRD135-BX-L	.135" Diameter Foam Spline	Black	8,000'	Box	8,000'	\$598.40

\*\* Available in bulk quantities

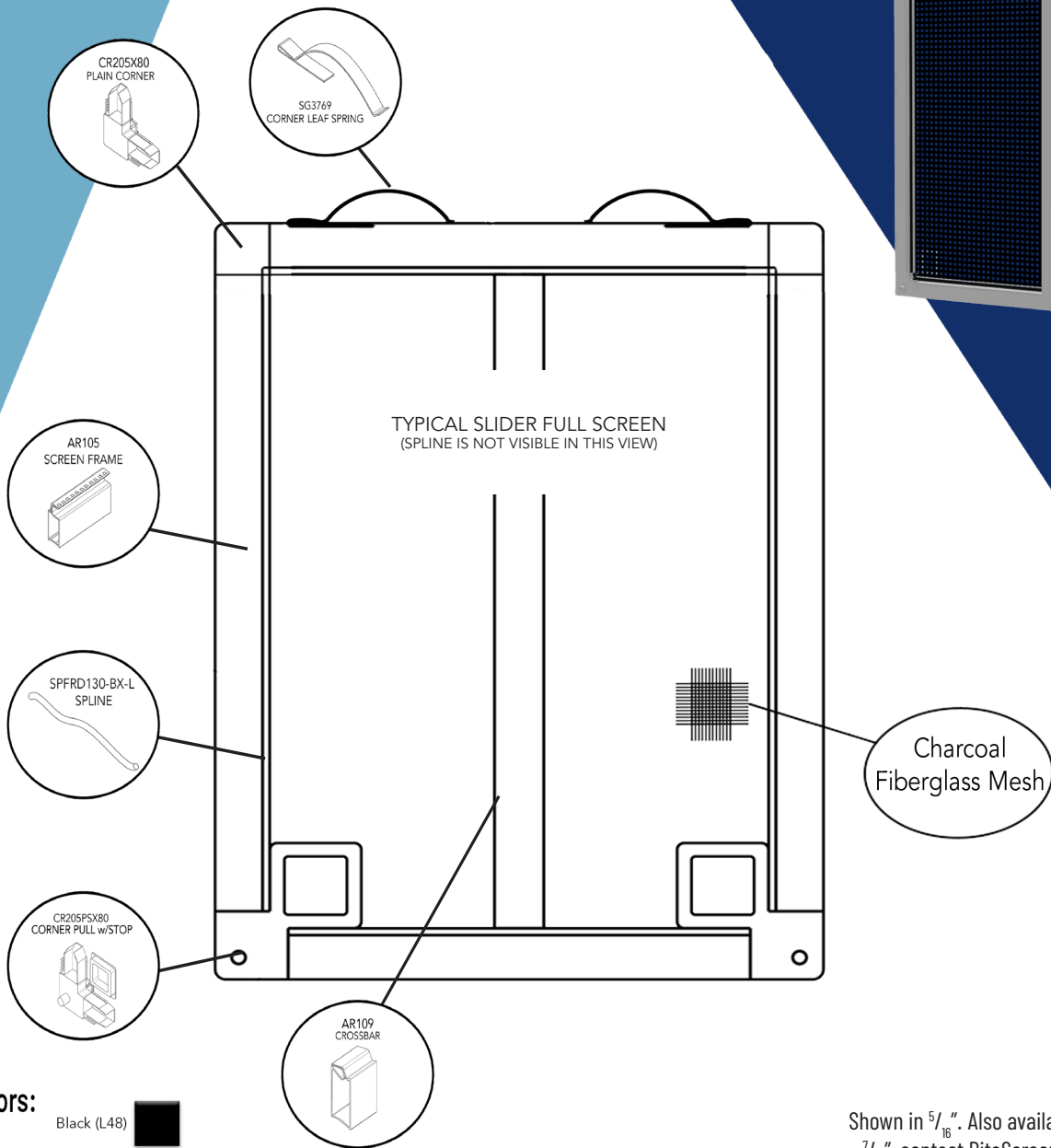
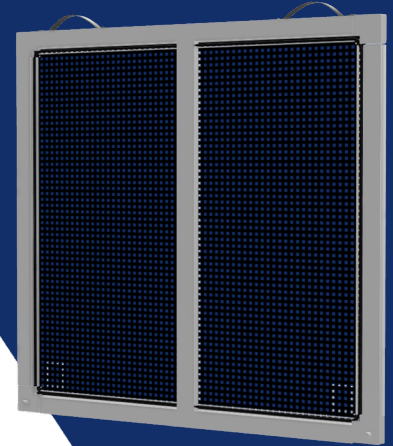

### Standard Colors:

XXX in part numbers are place holders for Color Code

White (C01)		Black (L48)	
Almond (A29)		Clay (A22)	
		Bronze (B16)	

Shown in  $\frac{5}{16}$ ". Also available in  $\frac{3}{8}$ " and  $\frac{7}{16}$ ", contact RiteScreen for details.

Series #	Fully Assembled Screen	Size	UOM	List Price
RFSL1	Minimum Price	0" to 49" UI	United Inch	\$22.66
RFSL1	U.I. Price	50" UI and Above	United Inch	\$0.4626

Part #	Description	Color	Length	UOM	QTY	List Price
AR105-16-12XXX	Screen Frame	Standard	12.5'	Box	152/pcs	\$1,583.72
AR109-16-11XXX	Crossbar	Standard	11.5'	Box	153/pcs	\$1,593.72
XCR205X80-XXX**	Plain Corner	Standard		Box	100/pcs	\$87.30
XCR205PSX80-XXX**	Corner Pull w/Stop	Standard		Box	100/pcs	\$98.39
XSG3769**	Leaf Spring	Mill		Box	100/pcs	\$376.56
MSFG36X100-L00	36" x 100' Char Fiber Mesh	Charcoal	100'	Roll	400 ft <sup>2</sup>	\$184.80
SPFRD130-BX-L	Foam Spline	Black	8,000'	Box	8,000'	\$506.88

\*\*Available in bulk quantities

# RFSL2 - Roll-Formed Slider Screen

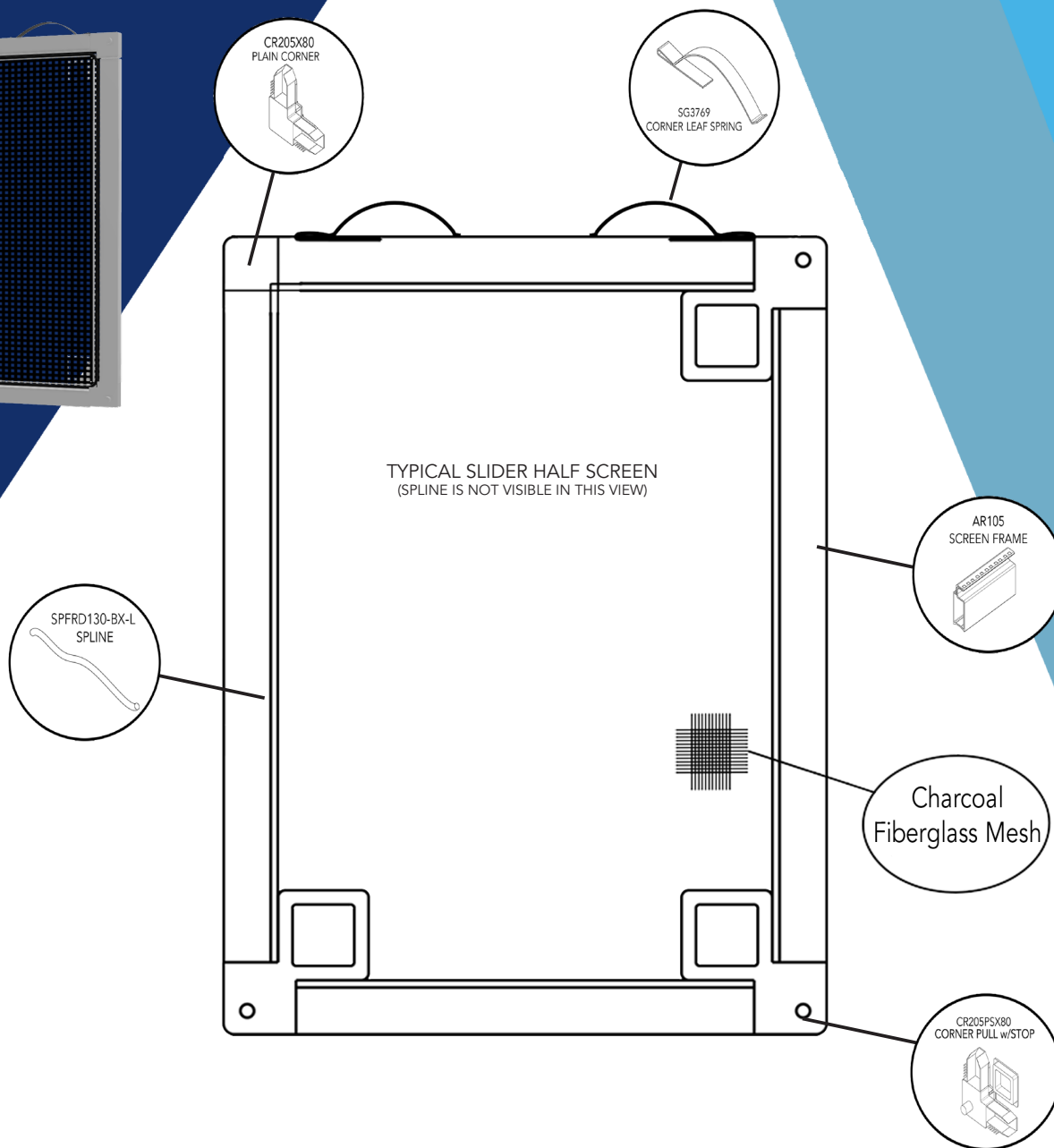
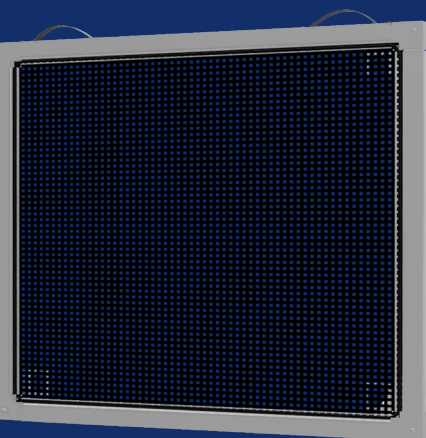

Shown in  $\frac{5}{16}$ ". Also available in  $\frac{3}{8}$ " and  $\frac{7}{16}$ ", contact RiteScreen for details.

### Standard Colors:

XXX in part numbers are place holders for Color Code



Series #	Fully Assembled Screen	Size	UOM	List Price
RFSL2	Minimum Price	0" to 49" UI	United Inch	\$21.44
RFSL2	U.I. Price	50" UI and Above	United Inch	\$0.4376

Part #	Description	Color	Length	UOM	QTY	List Price
AR105-16-12XXX	Screen Frame	Standard	12.5'	Box	152/pcs	\$1,583.72
XCR205X80-XXX**	Plain Corner	Standard		Box	100/pcs	\$87.30
XCR205PSX80-XXX**	Corner Pull w/Stop	Standard		Box	100/pcs	\$98.39
XSG3769**	Leaf Spring	Mill		Box	100/pcs	\$376.56
MMSG36X100-L00	36" x 100' Char Fiber Mesh	Charcoal	100'	Roll	400 ft <sup>2</sup>	\$184.80
SPFRD130-BX-L	Foam Spline	Black	8,000'	Box	8,000'	\$506.88

\*\*Available in bulk quantities

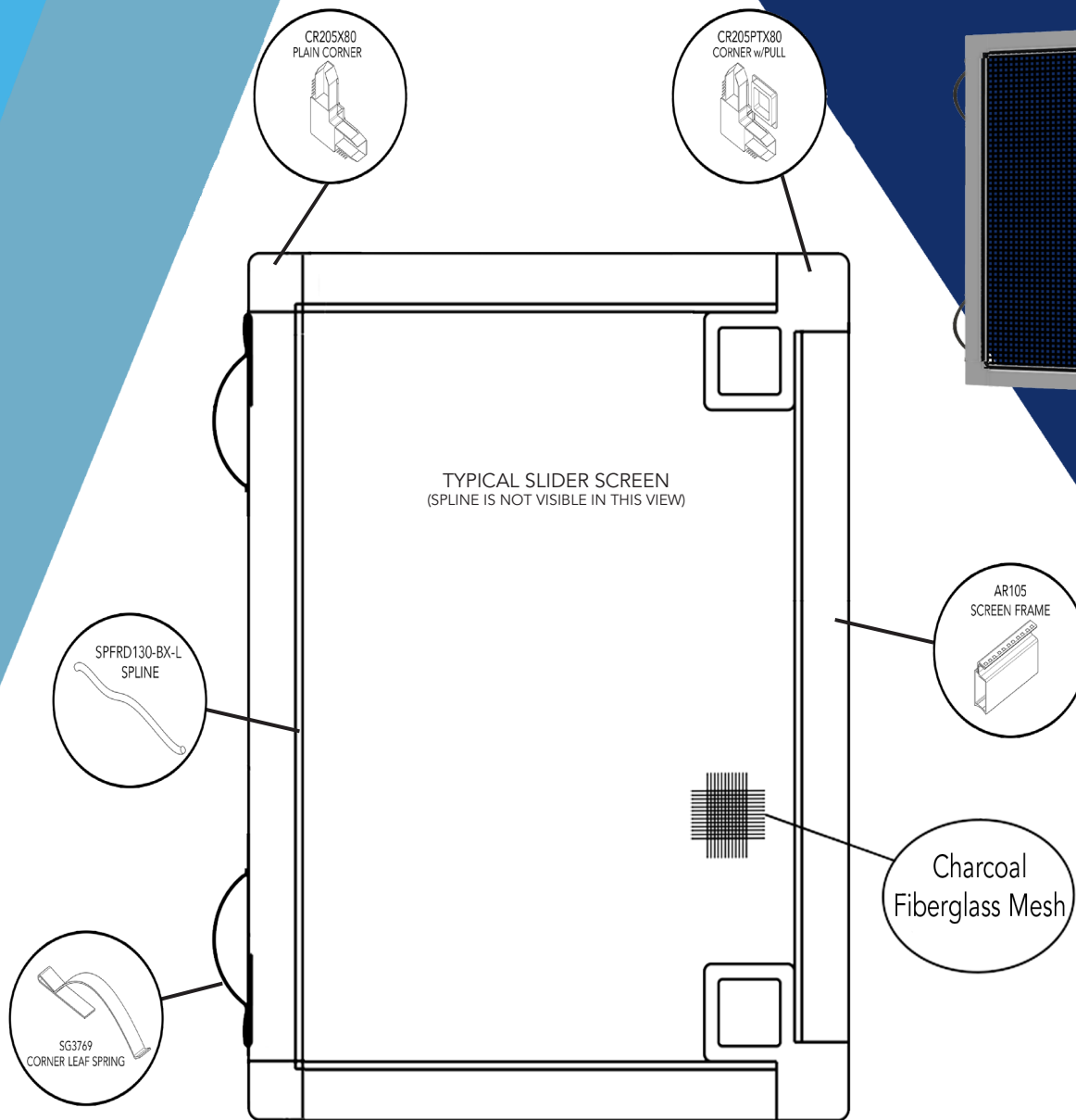

### Standard Colors:

XXX in part numbers are place holders for Color Code

White (C01)		Black (L48)	
Almond (A29)		Clay (A22)	
		Bronze (B16)	

Shown in  $\frac{5}{16}$ ". Also available in  $\frac{3}{8}$ " and  $\frac{7}{16}$ ", contact RiteScreen for details.

Series #	Fully Assembled Screen	Size	UOM	List Price
RFSL3	Minimum Price	0" to 49" UI	United Inch	\$22.58
RFSL3	U.I. Price	50" UI and Above	United Inch	\$0.4608
RFSL3-W	With Woolpile	50" UI and Above	United Inch	\$0.5174

Part #	Description	Color	Length	UOM	QTY	List Price
AR105-16-12XXX	Screen Frame	Standard	12.5'	Box	152/pcs	\$1,583.72
XCR205X80-XXX**	Plain Corner	Standard		Box	100/pcs	\$87.30
XCR205PTX80-XXX**	Corner w/Pull	Standard		Box	100/pcs	\$98.39
XSG3769**	Leaf Spring	Mill		Box	100/pcs	\$376.56
MSFG36X100-L00	36" x 100' Char Fiber Mesh	Charcoal	100'	Roll	400 ft <sup>2</sup>	\$184.80
SPFRD130-BX-L	Foam Spline	Black	8,000'	Box	8,000'	\$506.88

\*\*Available in bulk quantities

# RFFS1 - Roll-Formed Full Screen

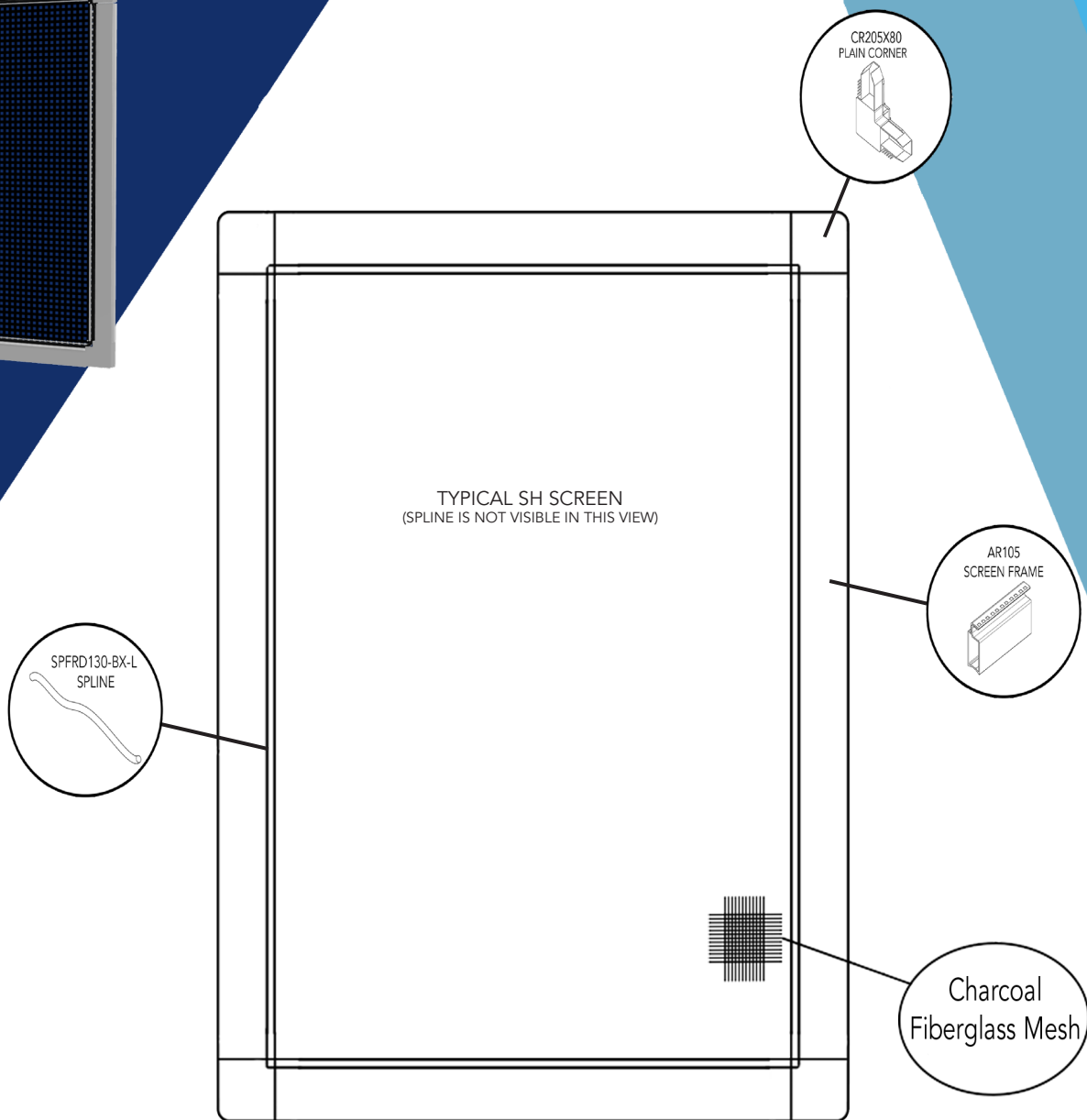
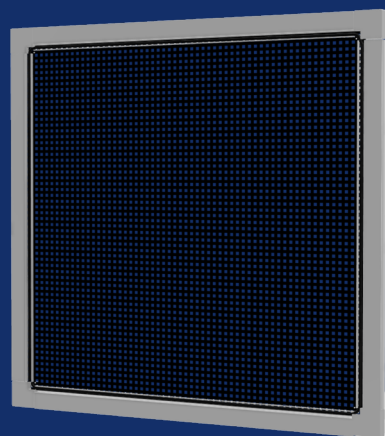

Shown in  $\frac{5}{16}$ ". Also available in  $\frac{3}{8}$ " and  $\frac{7}{16}$ ", contact RiteScreen for details.

Series #	Fully Assembled Screen	Size	UOM	List Price
RFFS1	Minimum Price	0" to 49" UI	United Inch	\$22.16
RFFS1	U.I. Price	50" UI and Above	United Inch	\$0.4520

### Standard Colors:

XXX in part numbers are place holders for Color Code



Part #	Description	Color	Length	UOM	QTY	List Price
AR105-16-12XXX	Screen Frame	Standard	12.5'	Box	152/pcs	\$1,583.72
XCR205X80-XXX**	Plain Corner	Standard		Box	100/pcs	\$87.30
MSFG36X100-L00	36" x 100' Char Fiber Mesh	Charcoal	100'	Roll	400 ft <sup>2</sup>	\$184.80
SPFRD130-BX-L	Foam Spline	Black	8,000'	Box	8,000'	\$506.88

\*\*Available in bulk quantities

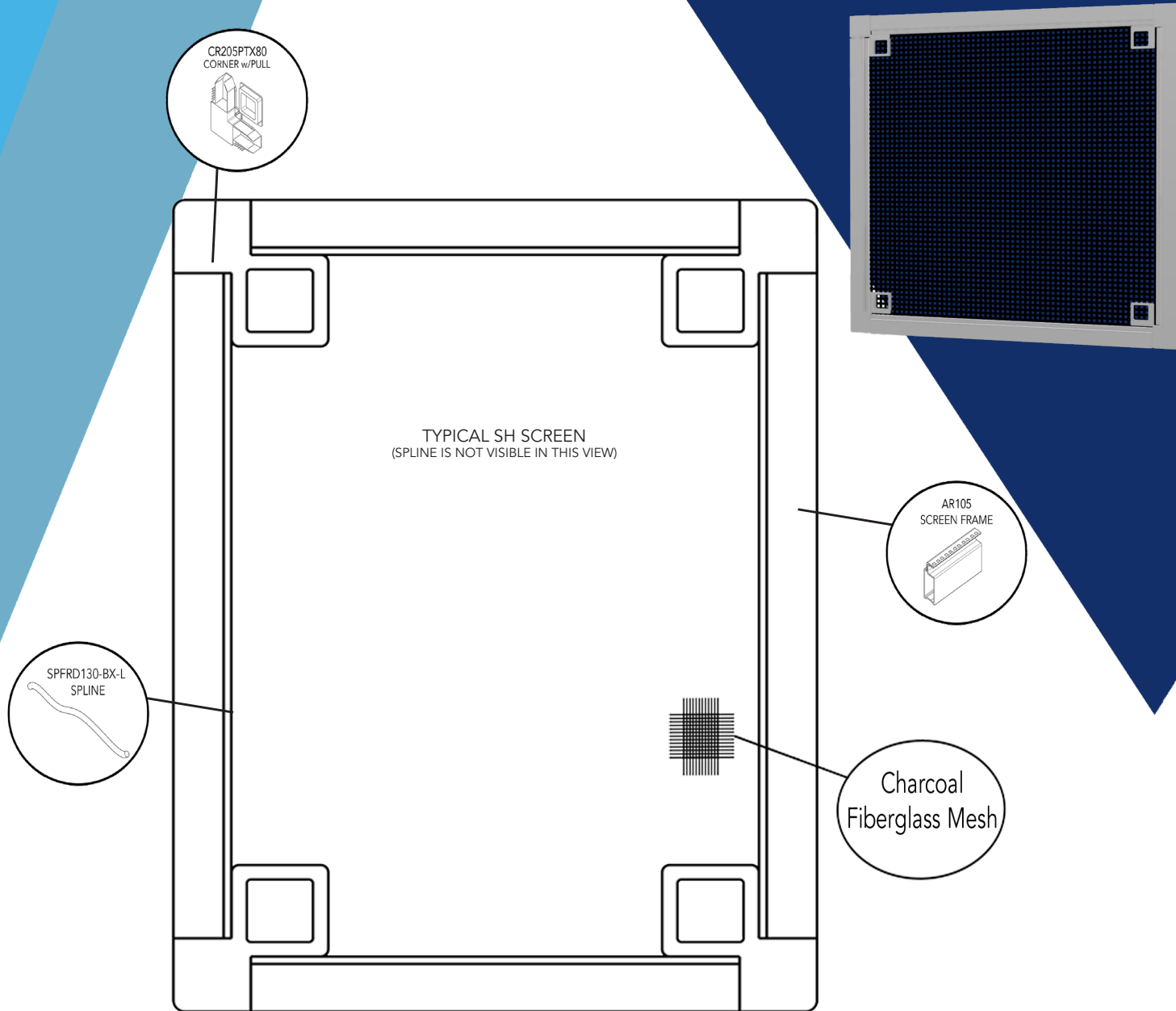

### Standard Colors:

XXX in part numbers are place holders for Color Code

Black (L48)	
White (C01)	
Almond (A29)	
Clay (A22)	
Bronze (B16)	

Shown in  $\frac{5}{16}$ ". Also available in  $\frac{3}{8}$ " and  $\frac{7}{16}$ ", contact RiteScreen for details.

Series #	Fully Assembled Screen	Size	UOM	List Price
RFFS2	Minimum Price	0" to 49" UI	United Inch	\$22.16
RFFS2	U.I. Price	50" UI and Above	United Inch	\$0.4520

Part #	Description	Color	Length	UOM	QTY	List Price
AR105-16-12XXX	Screen Frame	Standard	12.5'	Box	152/pcs	\$1,583.72
XCR205PTX80-XXX**	Corner w/Pull	Standard		Box	100/pcs	\$98.39
MSFG36X100-L00	36" x 100' Char Fiber Mesh	Charcoal	100'	Roll	400 ft <sup>2</sup>	\$184.80
SPFRD130-BX-L	Foam Spline	Black	8,000'	Box	8,000'	\$506.88

\*\*Available in bulk quantities



# RFCA1 - Roll-Formed Casement Screen

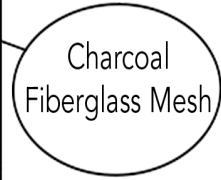
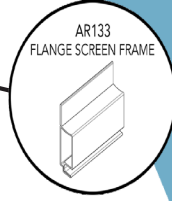
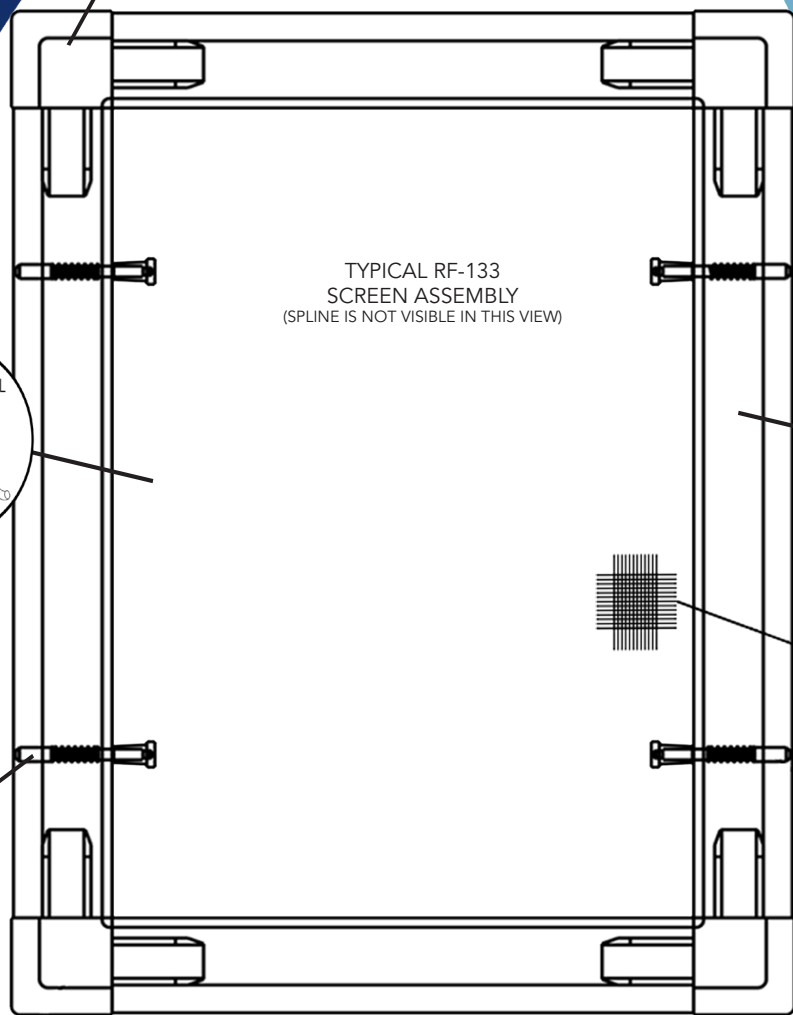
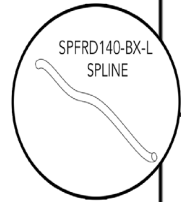
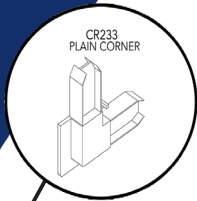
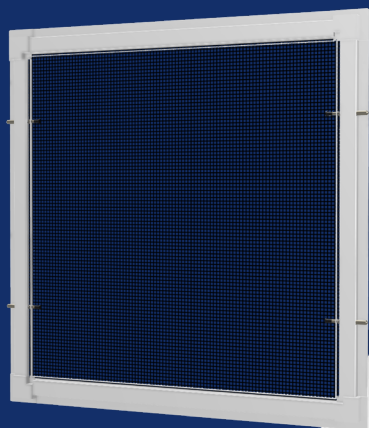

Shown in  $\frac{3}{8}$ "

### Standard Colors:



Series #	Fully Assembled Screen	Size	UOM	List Price
RFCA1	Minimum Price	0" to 49" UI	United Inch	\$25.96
RFCA1	U.I. Price	50" UI and Above	United Inch	\$0.5296

Part #	Description	Color	Length	UOM	QTY	List Price
AR133-16-12XXX	Flange Screen Frame	Standard	12.5'	Box	105/pcs	\$1,525.52
XCR233-XXX**	Plain Corner	Standard		Box	100/pcs	\$189.65
XPL315**	Plunger	Mill		Box	100/pcs	\$93.20
XSG412**	Plunger Spring	Mill		Bag	100/pcs	\$115.20
XPL308-XXX**	Plunger Cap	Standard		Box	100/pcs	\$75.51
SPFRD140-BX-L	Foam Spline	Black	8,000'	Box	8,000'	\$612.48
MSFG36X100-L00	36" x 100' Char Fiber Mesh	Charcoal	100'	Roll	400 ft <sup>2</sup>	\$184.80

\*\*Available in bulk quantities

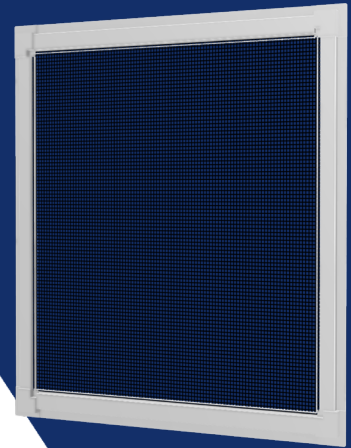
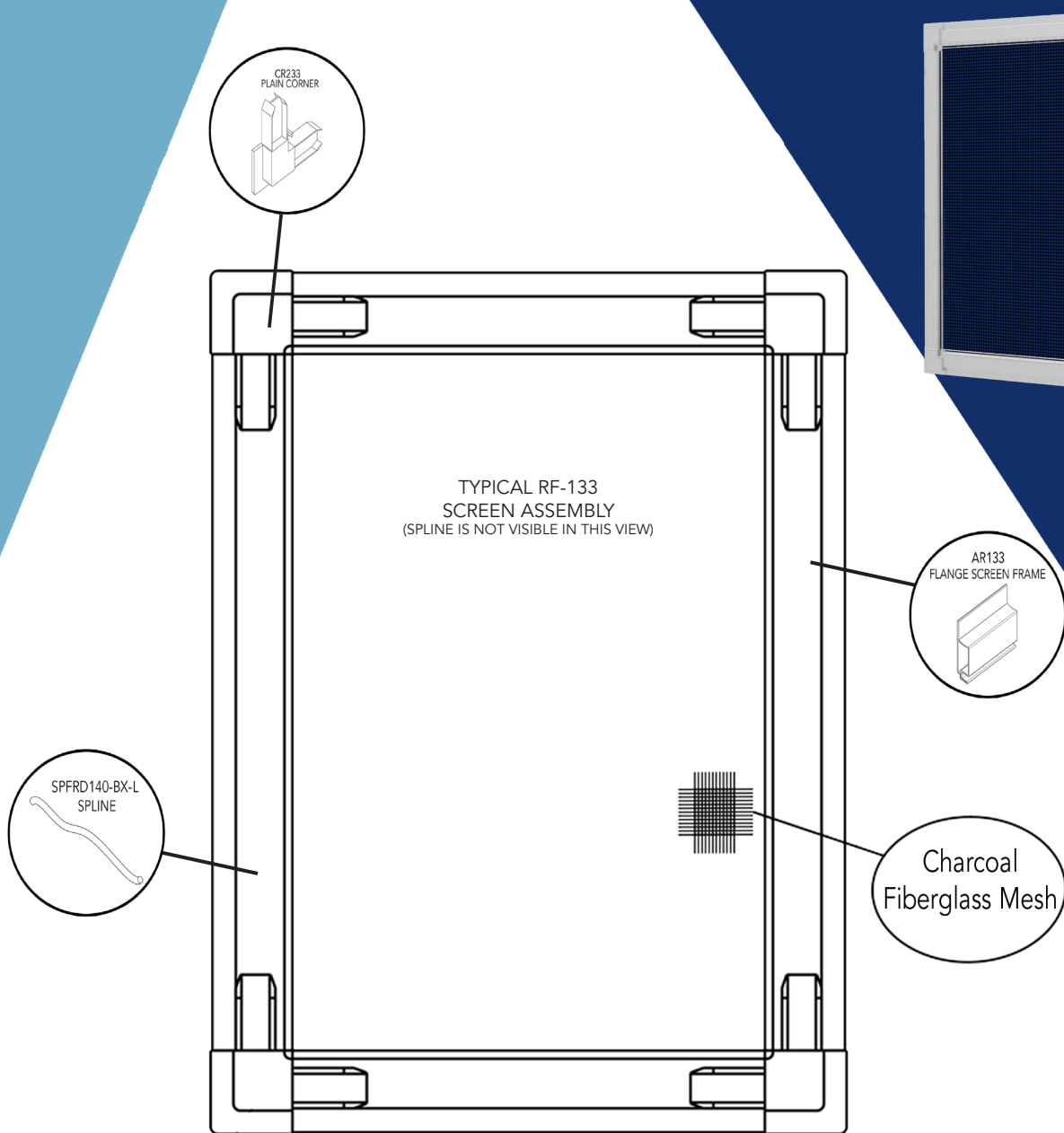

### Standard Colors:

XXX in part numbers are place holders for Color Code

White (C01)		Black (L48)	
Almond (A29)		Clay (A22)	
		Bronze (B16)	

Shown in  $\frac{3}{8}$ "

Series #	Fully Assembled Screen	Size	UOM	List Price
RFCA2	Minimum Price	0" to 49" UI	United Inch	\$24.30
RFCA2	U.I. Price	50" UI and Above	United Inch	\$0.4962

Part #	Description	Color	Length	UOM	QTY	List Price
AR133-16-12XXX	Flange Screen Frame	Standard	12.5'	Box	105/pcs	\$1,525.52
XCR233-XXX**	Plain Corner	Standard		Box	100/pcs	\$189.65
SPFRD140-BX-L	Foam Spline	Black	8,000'	Box	8,000'	\$612.48
MSFG36X100-L00	36" x 100' Char Fiber Mesh	Charcoal	100'	Roll	400 ft <sup>2</sup>	\$184.80

\*\*Available in bulk quantities

# RFCA3 - Roll-Formed Casement Screen

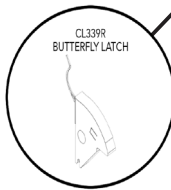
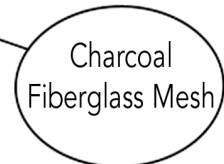
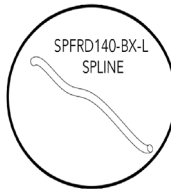
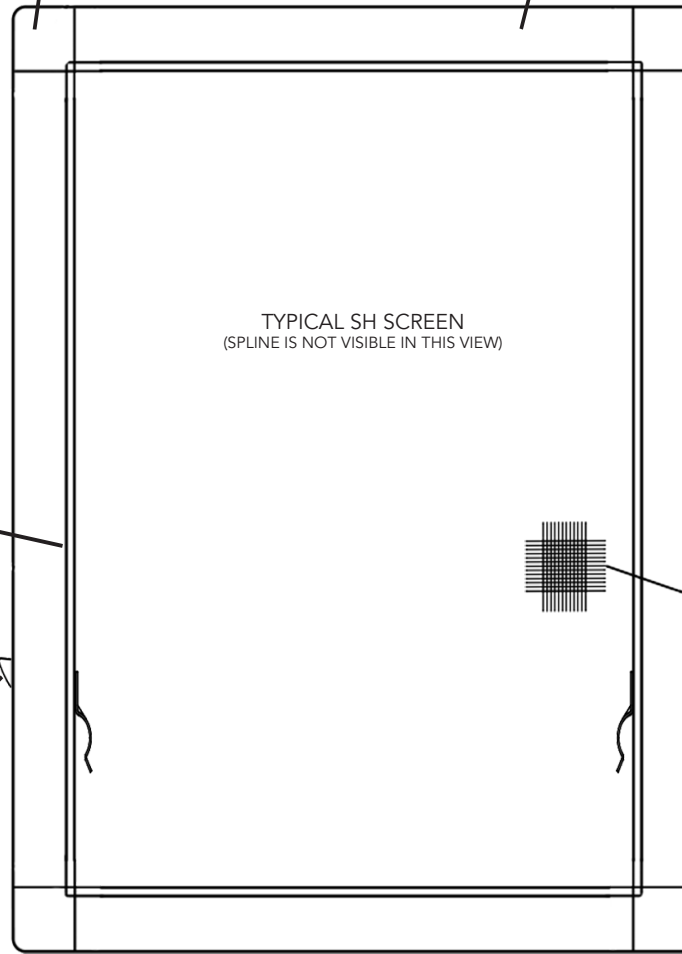
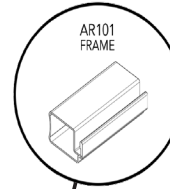
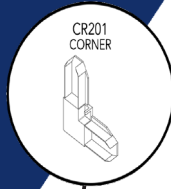

Shown in  $\frac{7}{16}$ "

### Standard Colors:

XXX in part numbers are place holders for Color Code

White (C01)

Almond (A29)

Black (L48)

Clay (A22)

Bronze (B16)

Series #	Fully Assembled Screen	Size	UOM	List Price
RFCA3	Minimum Price	0" to 49" UI	United Inch	\$26.84
RFCA3	U.I. Price	50" UI and Above	United Inch	\$0.5480

Part #	Description	Color	Length	UOM	QTY	List Price
AR101-16-12XXX	Screen Frame	Standard	12.5'	Box	112/pcs	\$1,293.64
XCR201-XXX**	Outside Corner	Standard		Box	100/pcs	\$174.69
XCL339R/L**	Butterfly Latch	Mill		Box	100/pcs	\$304.40
SPFRD140-BX-L	Foam Spline	Black	8,000'	Box	8,000'	\$612.48
MSFG36X100-L00	36" x 100' Char Fiber Mesh	Charcoal	100'	Roll	400 ft <sup>2</sup>	\$184.80

\*\*Available in bulk quantities

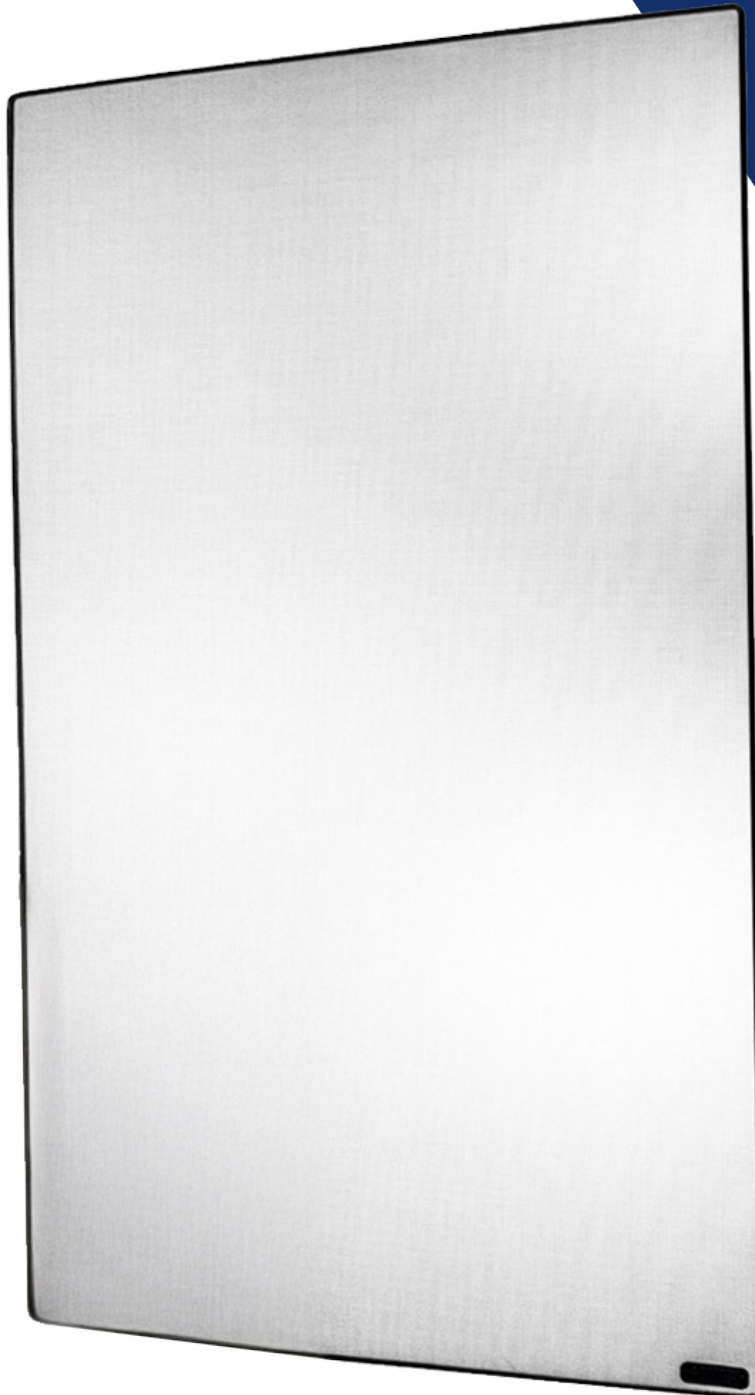
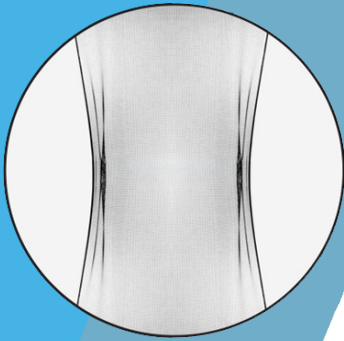

**For more information or to order:**  
**(888) 983-3539 • orders-pa@flexscreenmfg.com**

Series #	Fully Assembled Screen	Size	UOM	List Price
FlexScreen	Minimum Price	0" to 49" UI	United Inch	\$21.14
FlexScreen	U.I. Price	50" UI and Above	United Inch	\$0.5220



# PATIO DOOR SCREENS



**Love the air you breathe...**

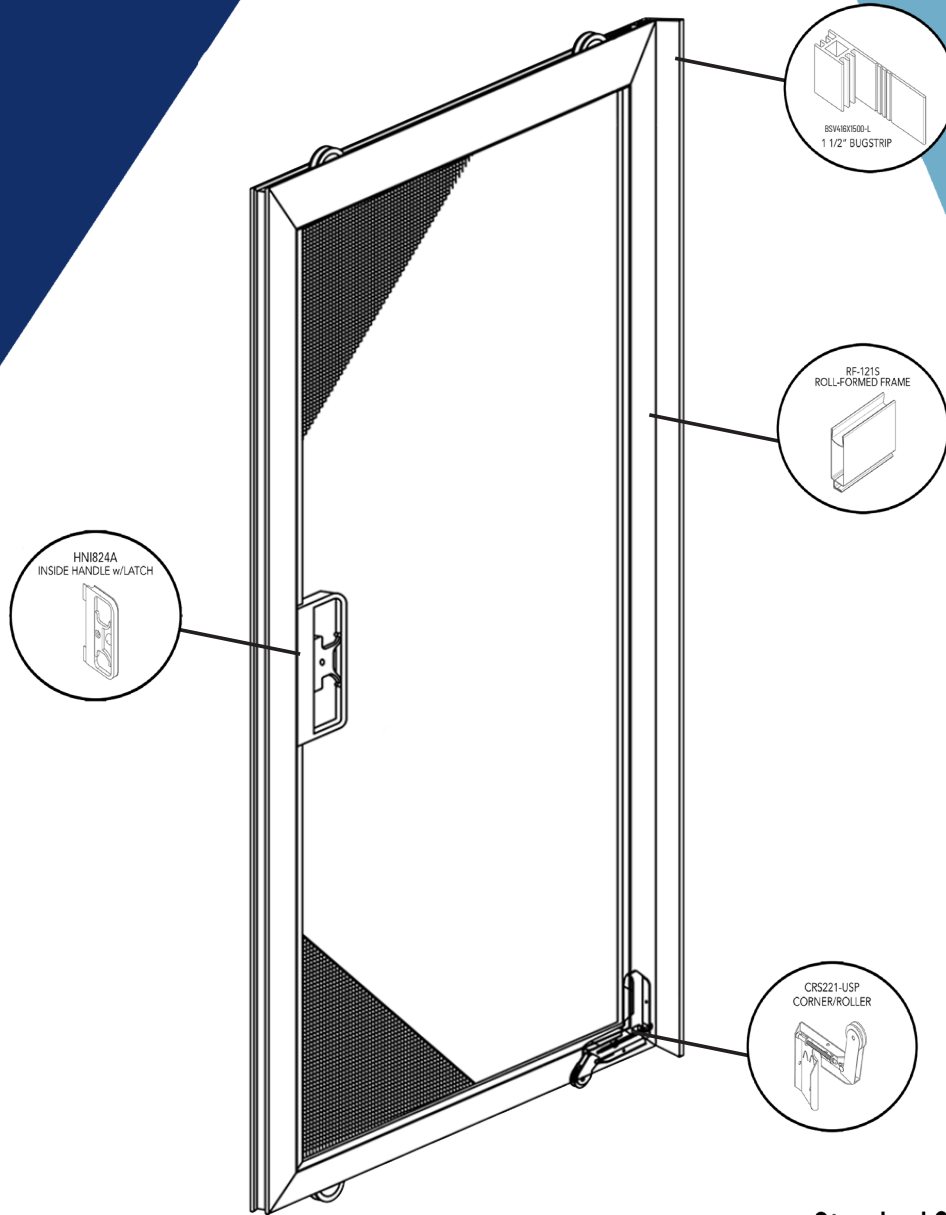

### Standard Colors



Part #	Description	QTY	List Price
RF-121S	Fully Assembled	United Inch	\$1.3672
CRS221-USS	Steel Roller	Optional	\$20.00/Unit

Part #	Description	Color	Length	UOM	QTY	List Price
SR121-19-100XXX	121 Steel Frame	Standard (No Black)	8.1'	Box	48/pcs	\$971.52
CR221-USP	Corner/Plastic Roller	Standard		Box	250/pcs	\$1,936.20
XHNI824A-L48**	Inside Handle w. Latch	Black		Box	100/box	\$286.71
XHNI824I-L48**	Outside Handle (Not Shown)	Black		Box	100/box	\$304.75
XHNS481-4**	Standard T Latch	Mill		Box	100/box	\$188.24
HB-1115-7	Standard Strike Bag (Not Shown)			Box	100/box	\$498.00
BSV416X1500-L	1.5" Bug Strip	Black	286'	Roll	286'	\$391.36

\*\*Available in bulk quantities

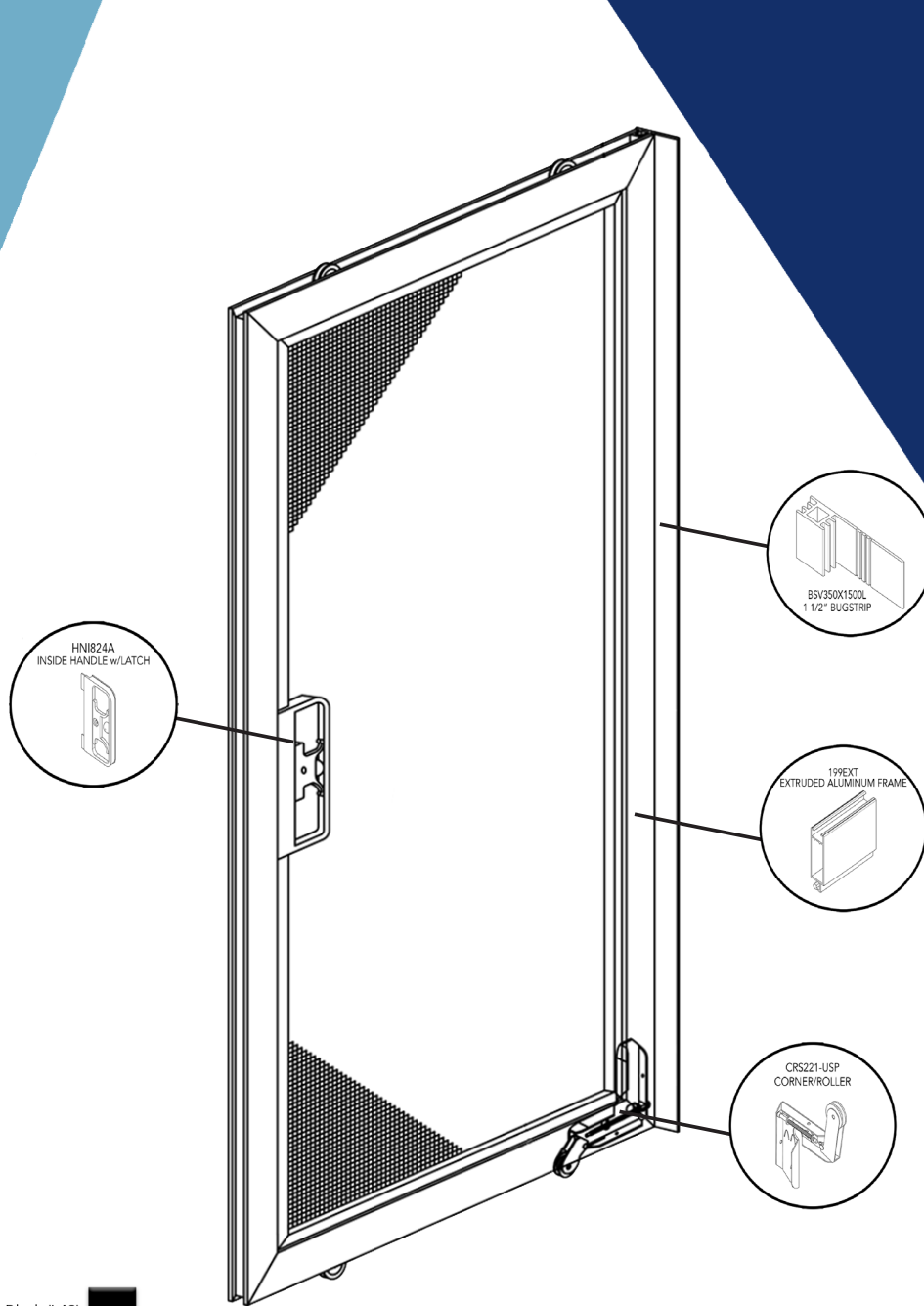

### Standard Colors:

XXX in part numbers are place holders for Color Code



Part #	Description	QTY	List Price
199EXT	Fully Assembled	United Inch	\$1.4786
CRS221-USS	Steel Roller	Optional	\$20.00/Unit

Part #	Description	Color	Length	UOM	QTY	List Price
EA1749-150-XXX	199EXT Extruded Aluminum Frame	Standard	12.5'	Box	10/pcs	\$1,248.77
CR221-USP	Corner/Plastic Roller	Standard		Box	250/pcs	\$1,936.20
XHNI824A-L48**	Inside Handle w. Latch	Black		Box	100/box	\$286.71
XHNI824I-L48**	Outside Handle (Not Shown)	Black		Box	100/box	\$304.75
XHNS481-4**	Standard T Latch	Mill		Box	100/box	\$188.24
HB-1115-3	Standard Strike Bag (Not Shown)			Box	100/box	\$498.00
BSV350X1500-L	1.5" Bug Strip	Black	286'	Roll	286'	\$217.20

\*\*Available in bulk quantities



# 170EXT - Extruded Patio Door Screen

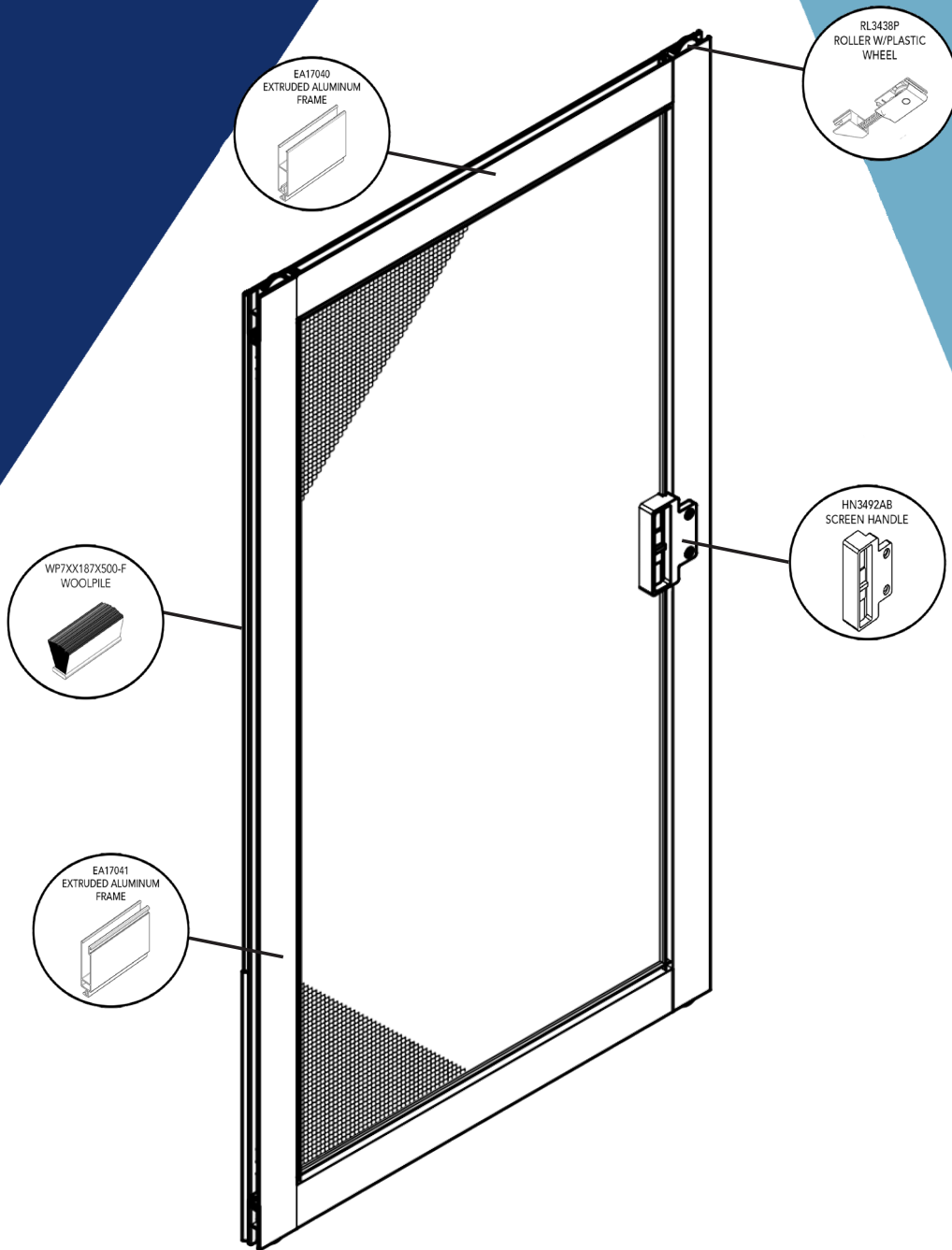
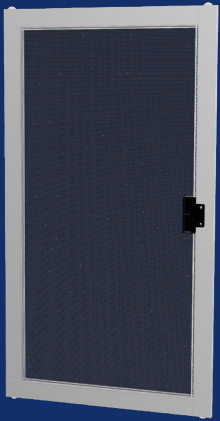

## Available Colors:

XXX in part numbers are  
place holders for the Color Code



Part #	Description	QTY	List Price
170EXT	Fully Assembled	United Inch	\$1.51
RL3438S	Steel Roller	Optional	\$20.00/Unit
RL3438SS	Stainless Roller	Optional	\$40.00/Unit

Part #	Description	Color	Length	UOM	QTY	List Price
EA17040-133-XXX	Extruded Aluminum Frame	See Chart	133"	Box	10/pcs	\$633.68
EA17041-133-XXX	Extruded Aluminum Frame	See Chart	133"	Box	10/pcs	\$599.77
XHN3492AB **	Screen Handle	Black		Box	100/box	\$927.52
XRL3438P **	Roller w/Plastic Wheel	Mill		Box	100/box	\$442.64
WP7XX187X500-F	.500" High Woolpile	Standard	1,500'	Roll	1,500'	\$448.80
HB1115-PHT	Strike Bag (not shown)	Standard		Box	100/box	\$169.96

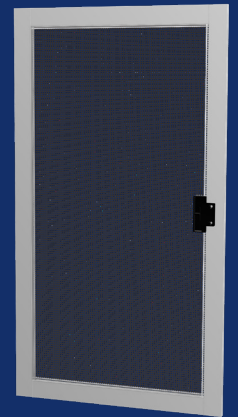
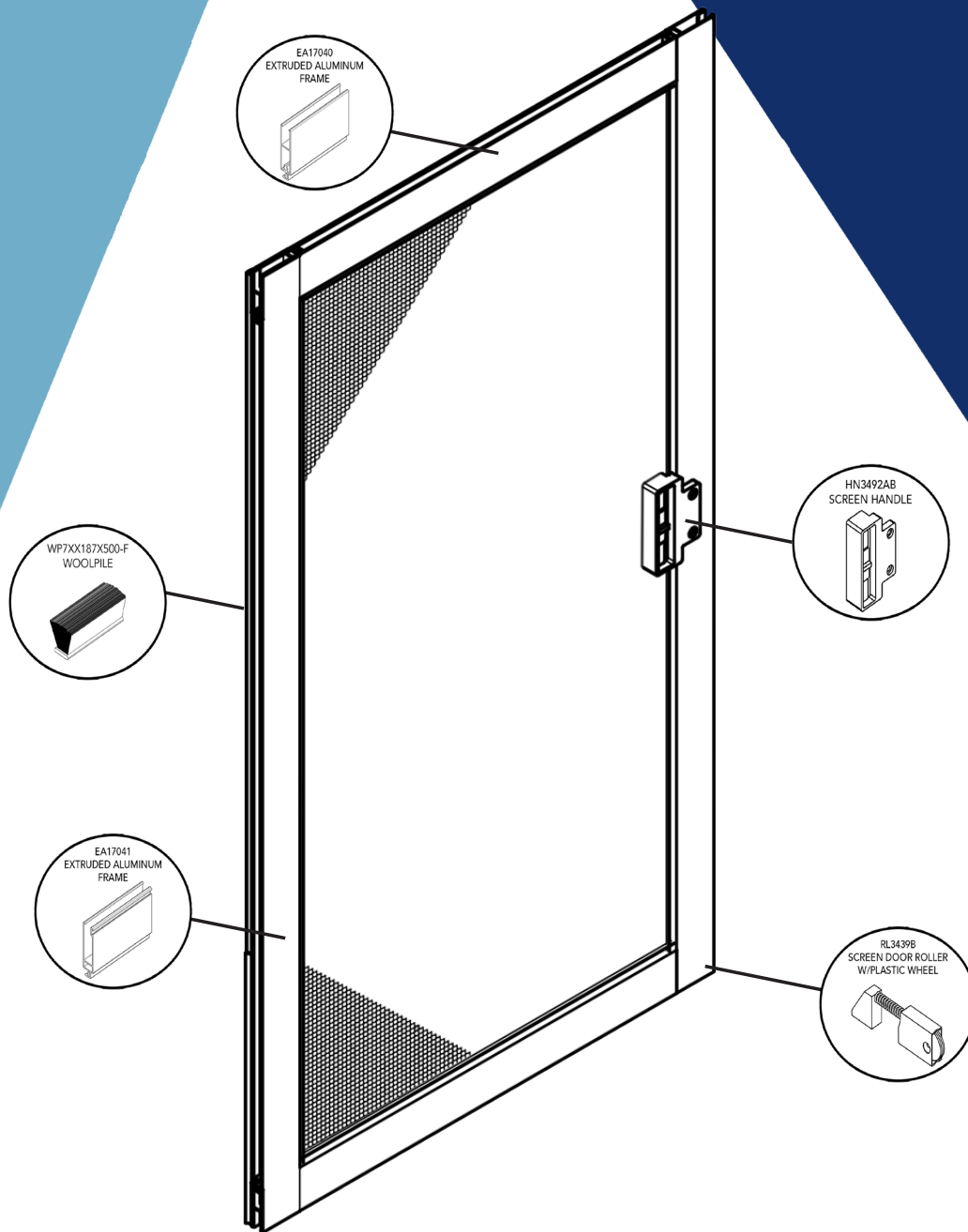

### Available Colors:

XXX in part numbers are place holders for the Color Code



Part #	Description	QTY	List Price
160EXT	Fully Assembled	United Inch	\$1.51

Part #	Description	Color	Length	UOM	QTY	List Price
EA17040-133-XXX	Extruded Aluminum Frame	See Chart	133"	Box	10/pcs	\$633.68
EA17041-133-XXX	Extruded Aluminum Frame	See Chart	133"	Box	10/pcs	\$599.77
XHN3492AB **	Screen Handle	Black		Box	100/box	\$927.52
XRL3439B **	Screen Door Roller w/Plastic Wheel	Mill		Box	100/box	\$907.28
WP7XX187X500-F	.500" High Woolpile	Standard	1,500'	Roll	1,500'	\$448.80
HB1115-PHT	Strike Bag (not shown)	Standard		Box	100/box	\$169.96

\*\*Available in bulk quantities

# 144EXT - Extruded Patio Door Screen

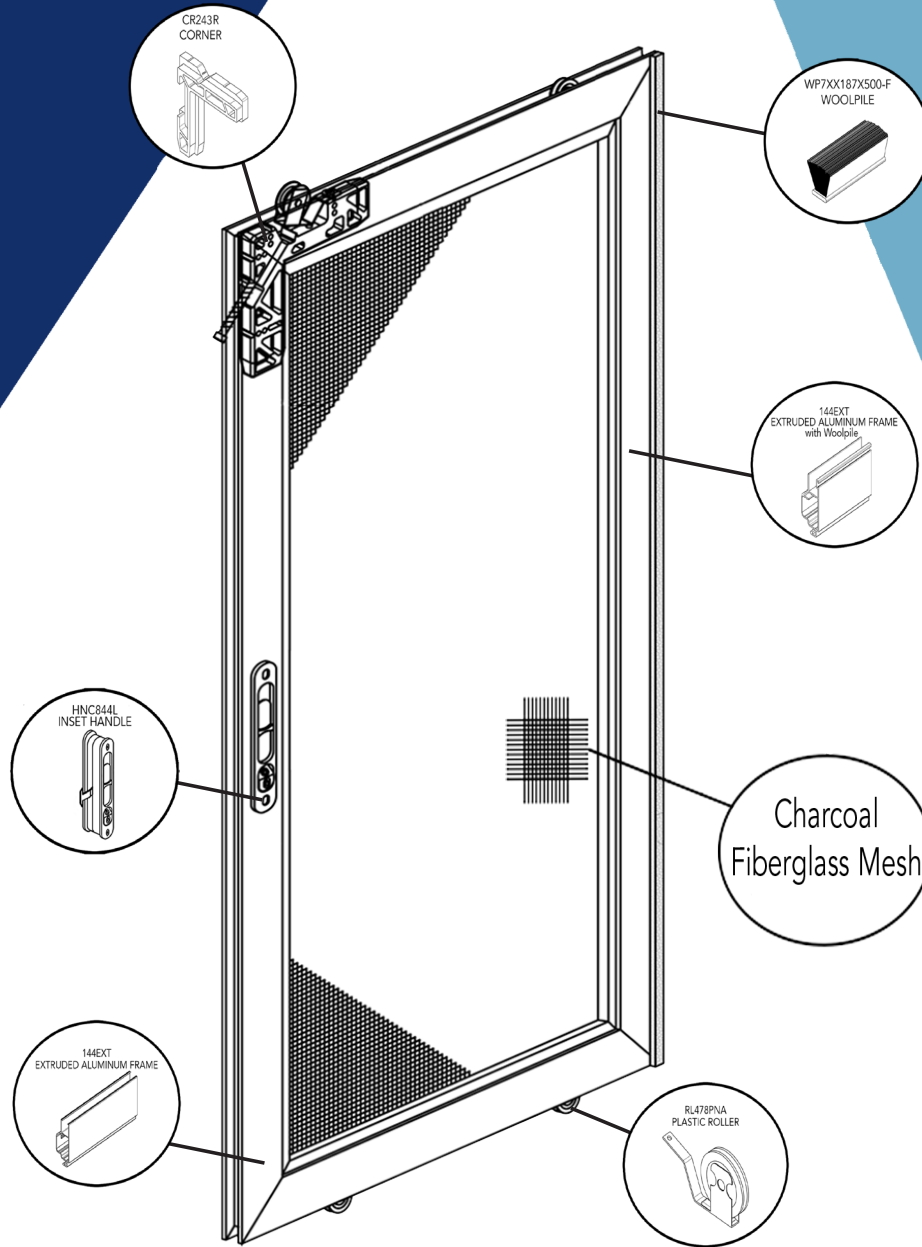

Part #	Description	QTY	List Price
144EXT	Fully Assembled	United Inch	\$1.6168
RL478S	Steel Roller	Optional	\$20.00/Unit
RL478ST	Stainless Steel Roller	Optional	\$40.00/Unit
144EXT Knock Down	Unassembled (packaging included)	1 per box	\$2.69/UI

### Standard Colors:

XXX in part numbers are  
place holders for Color Code

White (C01)

Almond (A29)

Black (L48)

Clay (A22)

Bronze (B16)

Part #	Description	Color	Length	UOM	QTY	List Price
EA16282-150-XXX	144EXT Extruded Aluminum Frame with Woolpile	Standard	12.5'	Box	10/pcs	\$1,267.90
EA16289-150-XXX	144EXT Extruded Aluminum Frame	Standard	12.5'	Box	10/pcs	\$1,267.90
XCR243R/L	Corner	Standard		Box	600/pcs	\$528.80
XRL478PNA**	Plastic Roller	Mill		Box	100/box	\$229.60
XHNC844R/L-L48**	Inset Black Composite Handle, Left	Black		Box	100/pcs	\$1,306.72
HB-1115-9	Standard Strike Bag (Not Shown)			Box	100/box	\$498.00
WP7XX187X500-F	.500" High Woolpile	Standard	1,500'	Roll	1,500'	\$448.80

\*\*Available in bulk quantities

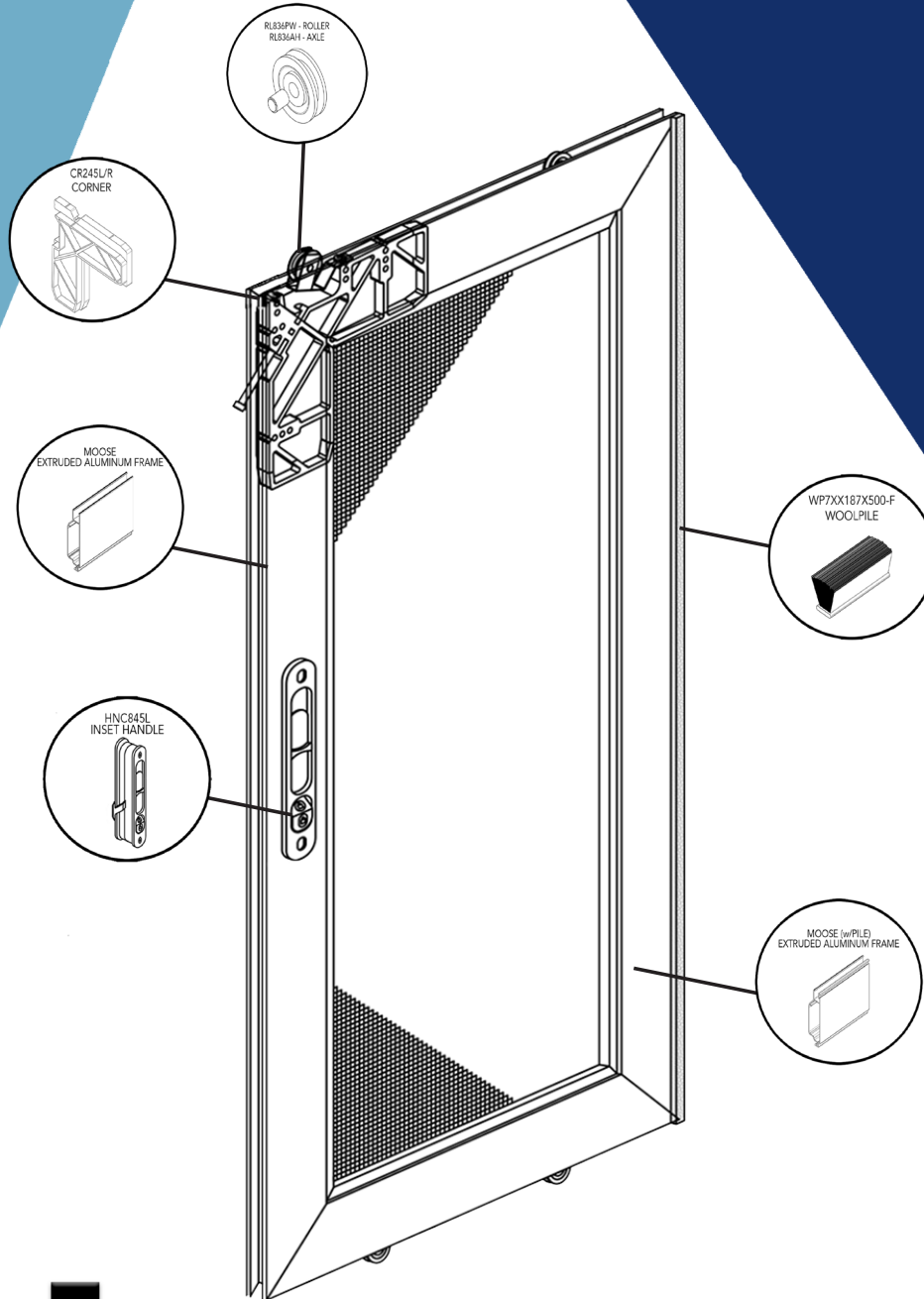

### Standard Colors:

XXX in part numbers are place holders for Color Code

Black (L48)	
White (C01)	
Almond (A29)	
Clay (A22)	
Bronze (B16)	

Part #	Description	QTY	List Price
MOOSE	Fully Assembled	United Inch	\$2.0342
RL478S	Steel Roller	Optional	\$20.00/Unit
RL478ST	Stainless Steel Roller	Optional	\$40.00/Unit

Part #	Description	Color	Length	UOM	QTY	List Price
EA17011-150-XXX	MOOSE Extruded Aluminum Frame with Woolpile	Standard	12.5'	Box	10/pcs	\$1,816.44
EA17010-150-XXX	MOOSE Extruded Aluminum Frame	Standard	12.5'	Box	10/pcs	\$1,747.60
XCR245R/L	Corner	Standard		Box	200/pcs	\$847.98
XRL836PW	Plastic Roller	White		Box	100/box	\$92.06
XRL836AH	Steel Axle	Mill		Box	100/Box	\$79.12
XHNC845R/L-L48**	Inset Black Composite Handle, Left	Black		Box	100/pcs	\$1,391.20
HB-1115-9	Standard Strike Bag (Not Shown)			Box	100/box	\$498.00
WP7XX187X500-F	.500" High Woolpile	Standard	1,500'	Roll	1,500'	\$448.80

\*\*Available in bulk quantities

# 121SMFIT - Standard Multi-Fit Patio Door

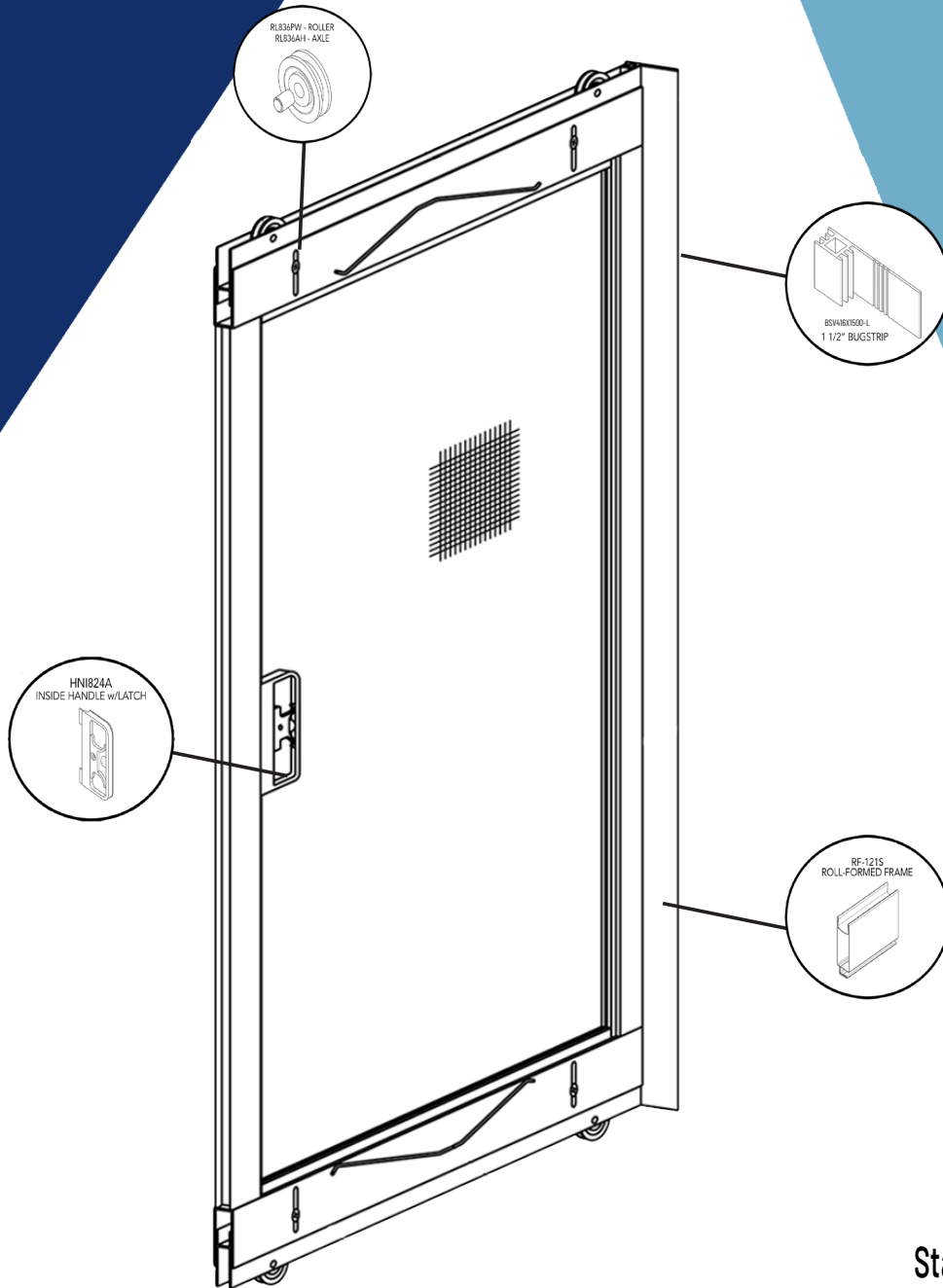

## Standard Colors



Series	Fully Assembled Screen	Width	List Price
121SMFIT	Standard Multi-Fit Patio Door	30"	\$143.82
121SMFIT	Standard Multi-Fit Patio Door	36"	\$155.80
121SMFIT	Standard Multi-Fit Patio Door	48"	\$179.78

Part #	Description	Color	Length	UOM	QTY	List Price
SR121-19-100XXX	121 Steel Frame	Standard (No Black)	8.1'	Box	48/pcs	\$971.52
XHNI824A-L48**	Inside Handle w. Latch	Black		Box	100/box	\$286.71
XHNI824I-L48**	Outside Handle (Not Shown)	Black		Box	100/box	\$304.75
XRL836PW	Plastic Roller	White		Box	100/box	\$92.06
XRL836AH	Steel Axle	Mill		Box	100/Box	\$79.12
BSV416X1500-L	1.5" Bug Strip	Black	286'	Roll	286'	\$391.36

\*\*Available in bulk quantities

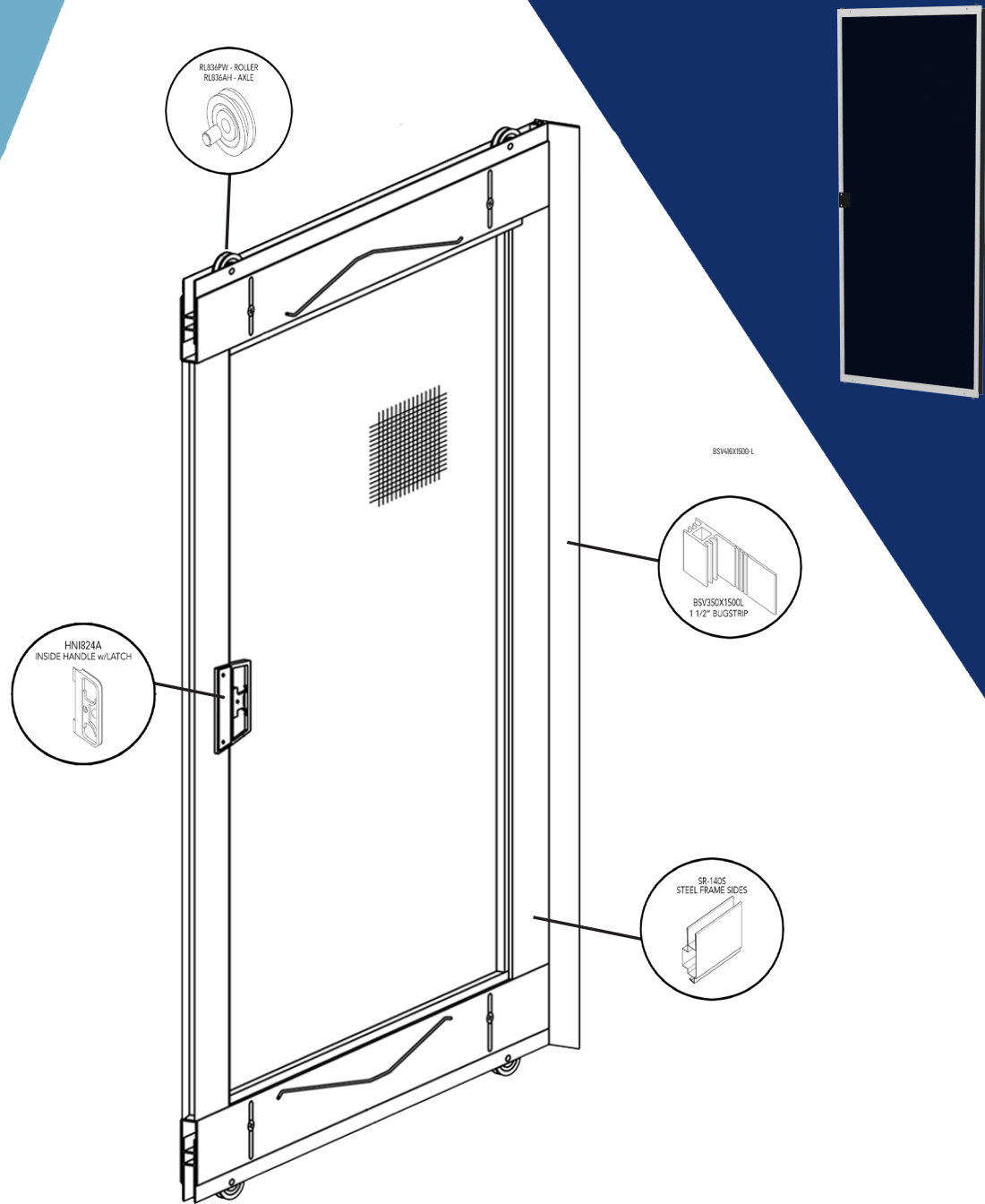

## Standard Colors



Series	Fully Assembled Screen	Width	List Price
140SMFIT	Premium Multi-Fit Patio Door	30"	\$154.76
140SMFIT	Premium Multi-Fit Patio Door	36"	\$164.42
140SMFIT	Premium Multi-Fit Patio Door	48"	\$183.76

Part #	Description	Color	Length	UOM	QTY	List Price
SR140-19-100XXX	140 Steel Frame	Standard (No Black)	8.1'	Box	27/Box	\$1,465.20
XHNI824A-L48**	Inside Handle w. Latch	Black		Box	100/box	\$286.71
XHNI824I-L48**	Outside Handle (Not Shown)	Black		Box	100/box	\$304.75
XRL836PW	Plastic Roller	White		Box	100/box	\$92.06
XRL836AH	Steel Axle	Mill		Box	100/Box	\$79.12
BSV416X1500-L	1.5" Bug Strip	Black	286'	Roll	286'	\$391.36

\*\*Available in bulk quantities

# MOOSEFIT - Ultimate Multi-Fit Patio Door

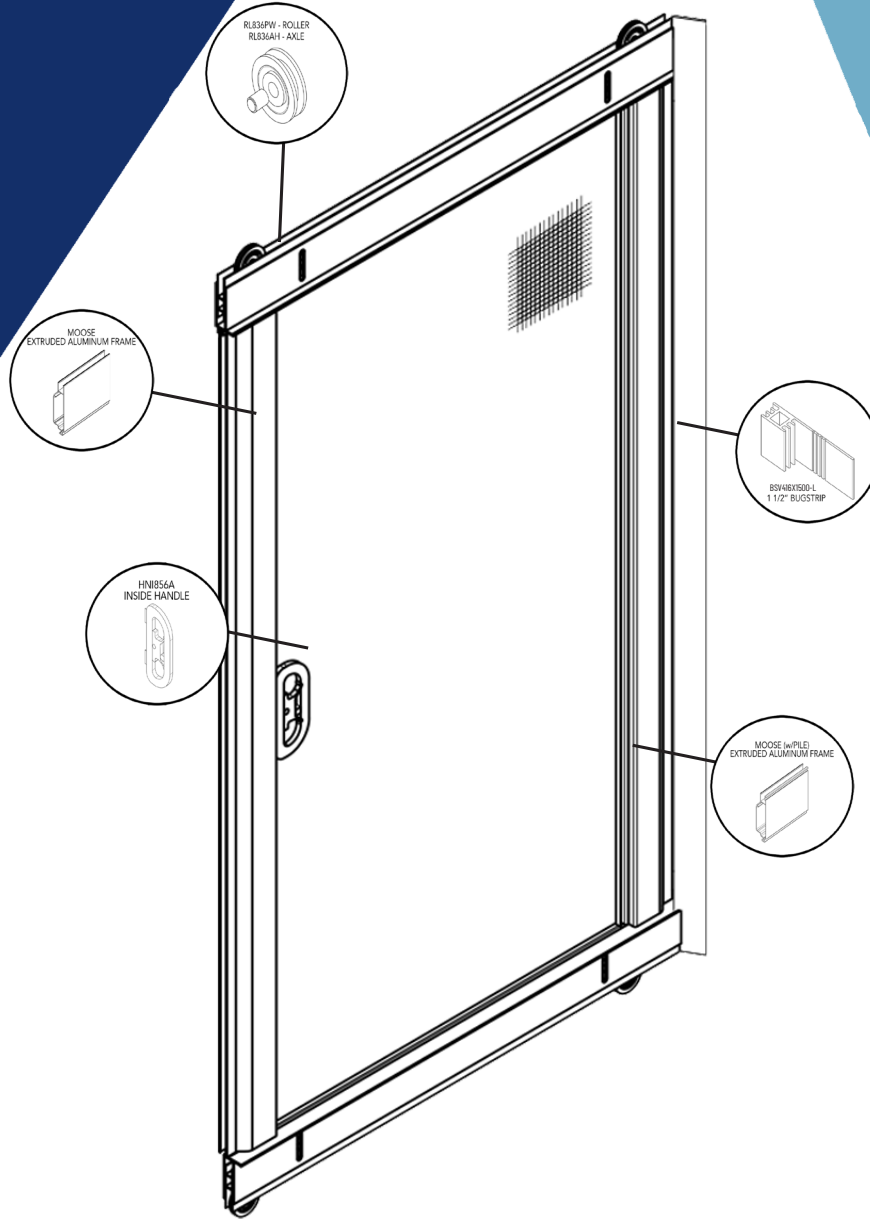

## Standard Colors



Series	Fully Assembled Screen	Width	List Price
MOOSEFIT	Ultimate Multi-Fit Patio Door	30"	\$229.74
MOOSEFIT	Ultimate Multi-Fit Patio Door	36"	\$242.22
MOOSEFIT	Ultimate Multi-Fit Patio Door	48"	\$267.18

Part #	Description	Color	Length	UOM	QTY	List Price
EA17011-150-XXX	MOOSE Extruded Aluminum Frame with Woolpile	Standard	12.5'	Box	10/pcs	\$1,816.44
EA17010-150-XXX	MOOSE Extruded Aluminum Frame	Standard	12.5'	Box	10/pcs	\$1,747.60
XHNI856A-L48	Inside Handle	Black		Box	100/pcs	\$336.61
XHNI857-L48	Outside Handle (Not Shown)	Black		Box	100/pcs	\$356.58
XRL836PW	Plastic Roller	White		Box	100/box	\$92.06
XRL836AH	Steel Axle	Mill		Box	100/Box	\$79.12
BSV416X1500-L	1.5" Bug Strip	Black	286'	Roll	286'	\$391.36

\*\*Available in bulk quantities

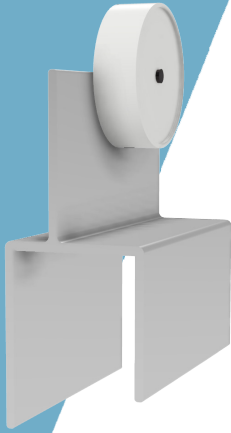

**EAOP033-150-XXX**  
**Top Hung Adapter**



**EAOP007-144-XXX**  
**Top Hung Track**

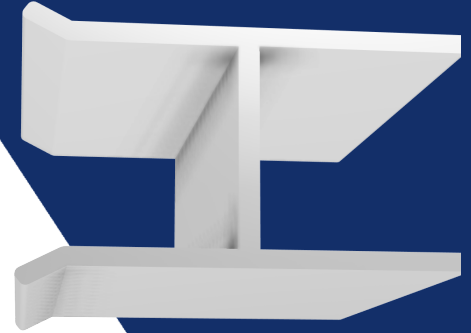

**EA1255-100-XXX**  
**Astragal**

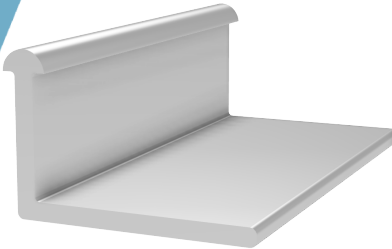

**EA42546-120-XXX**  
**Sill Track**

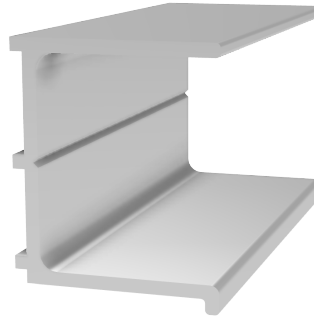

**EAOP006-166-XXX**  
**Jamb Track**



**EA1002-120-XXX**  
**Top Track**

**Standard Colors:**

XXX in part numbers are  
place holders for Color Code



Part #	Description	Color	Length	UOM	QTY	List Price
EAOP033-150-XXX	Top Hung Adapter	Standard	150"	Box	20/pcs	\$1,184.26
EAOP007-144-XXX	Top Hung Track	Standard	144"	Box	20/pcs	\$1,074.59
EA1255-100-XXX	Astragal	Black, White	100"	Box	20/pcs	\$765.60
EA42546-120-XXX	Sill Track	Standard	120"	Box	20/pcs	\$333.70
EAOP006-166-XXX	Jamb Track	Standard	166"	Box	20/pcs	\$949.52
EA1002-120-XXX	Top Track	Standard	120"	Box	20/pcs	\$770.35

**Additional Charges**

Cut-To-Fit	+\$6.00/piece
Cut and Fabricated	+\$12.00/piece



The Signature is an out-swing screen door which complements “top of the line” French Patio doors. The premium engineering of this screen door was specifically designed for easy installation on elite In-Swing French doors.

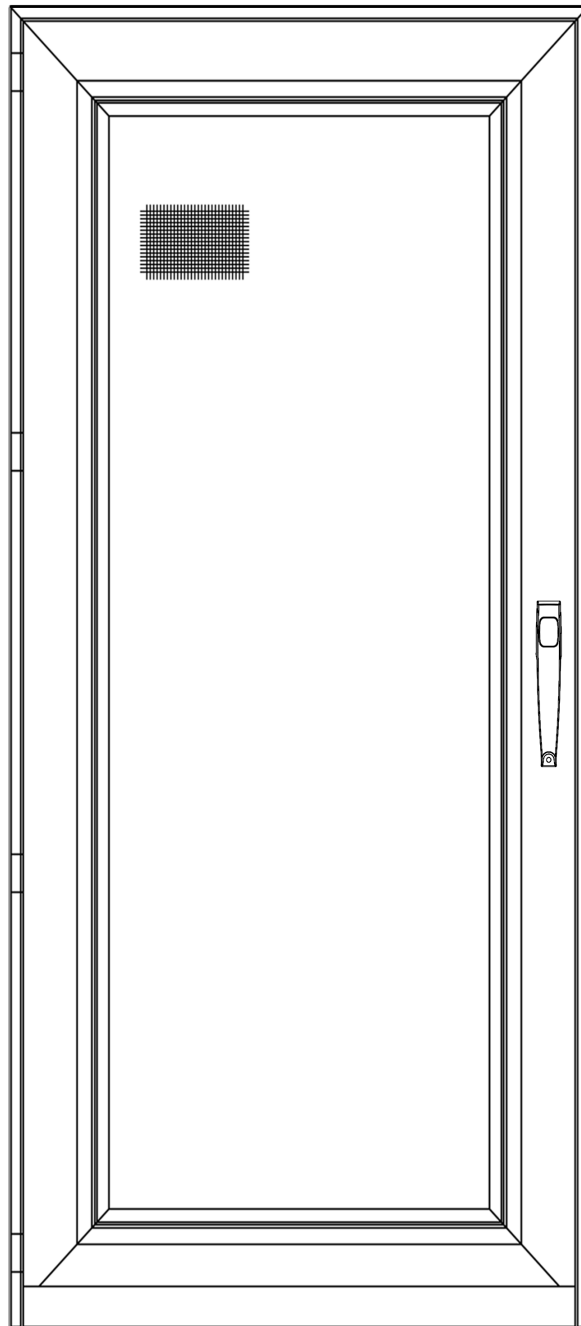

### Standard Colors:

XXX in part numbers are  
place holders for Color Code

White (C01)



Black (L48)



Clay (A22)



Almond (A29)



Bronze (B16)



Part #	Description	QTY	List Price
SIGNATURE.SGL	Single Swing Door	United Inch	\$6.0434

The Signature's 3" wide, sturdy, extruded frame makes it an excellent choice for 6'8" & 8'0" high doors, as well as custom widths and heights. The screening is attached directly to the door frame, which eliminates the need for unsightly clips to retain a separate screen in place.

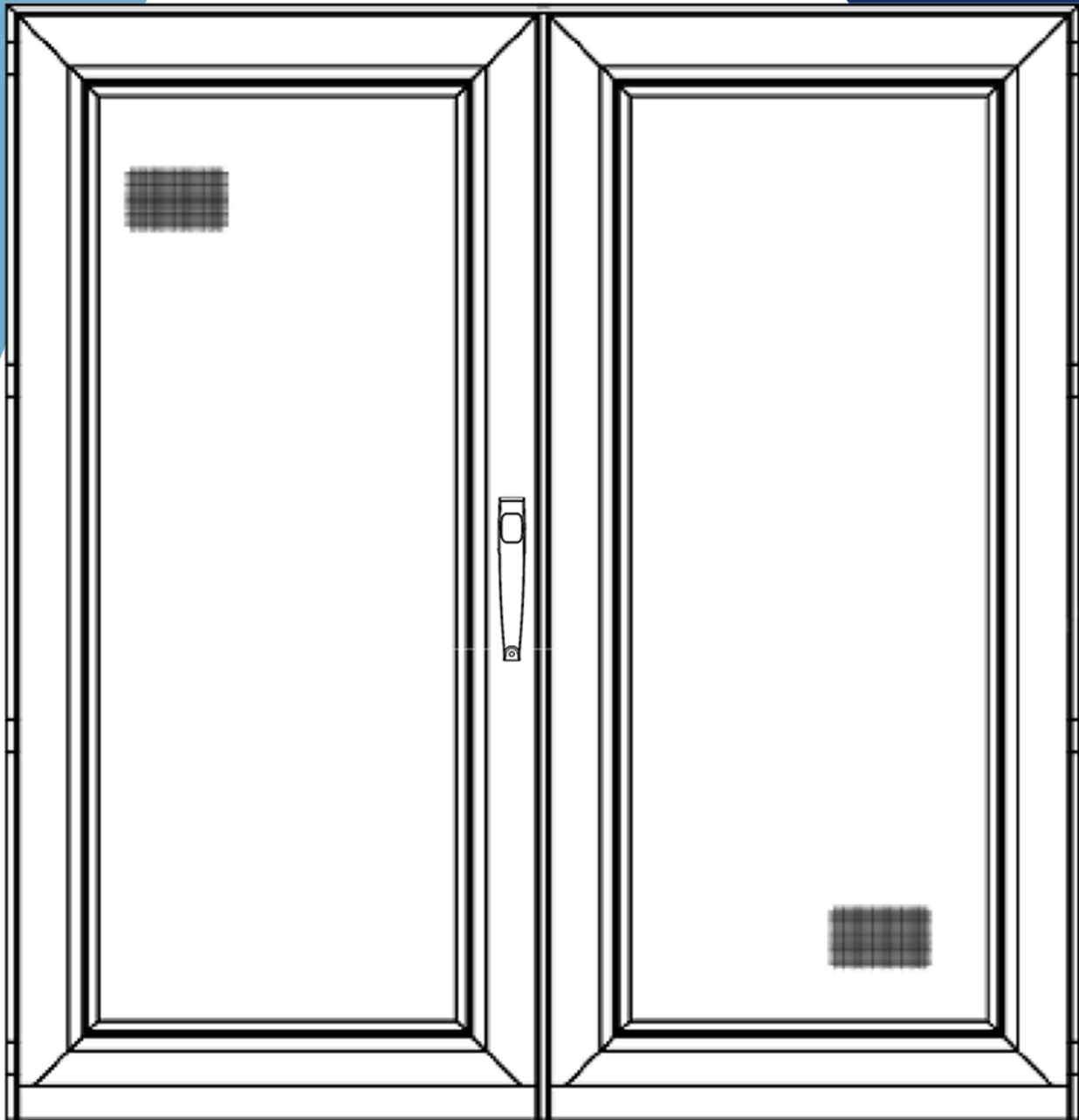

### Standard Colors:

XXX in part numbers are place holders for Color Code

White (C01)



Black (L48)



Clay (A22)



Almond (A29)



Bronze (B16)



Part #	Description	QTY	List Price
SIGNATURE.DBL	Double Swing Door	United Inch	\$8.3001

A woman with long brown hair, wearing a dark grey knit sweater, is looking out a white-framed patio door. The door has a screen mesh. Her hand is resting on the door frame. The background shows a blurred outdoor scene with green foliage and a bright sky. A dark blue horizontal bar is overlaid across the middle of the image, containing the text 'KNOCK-DOWN PATIO DOOR KITS' in white, bold, uppercase letters.

# KNOCK-DOWN PATIO DOOR KITS

A person is seen from the side, looking out a window. The window has a white screen door with a white handle. The view outside is a blurred green landscape with trees and a wooden fence. The text is overlaid on a dark blue horizontal band across the middle of the image.

**Simple set up, Tailored Solutions,  
Endless Options...**

# Ultimate Multi-Fit Knock-Down Patio Door Kit

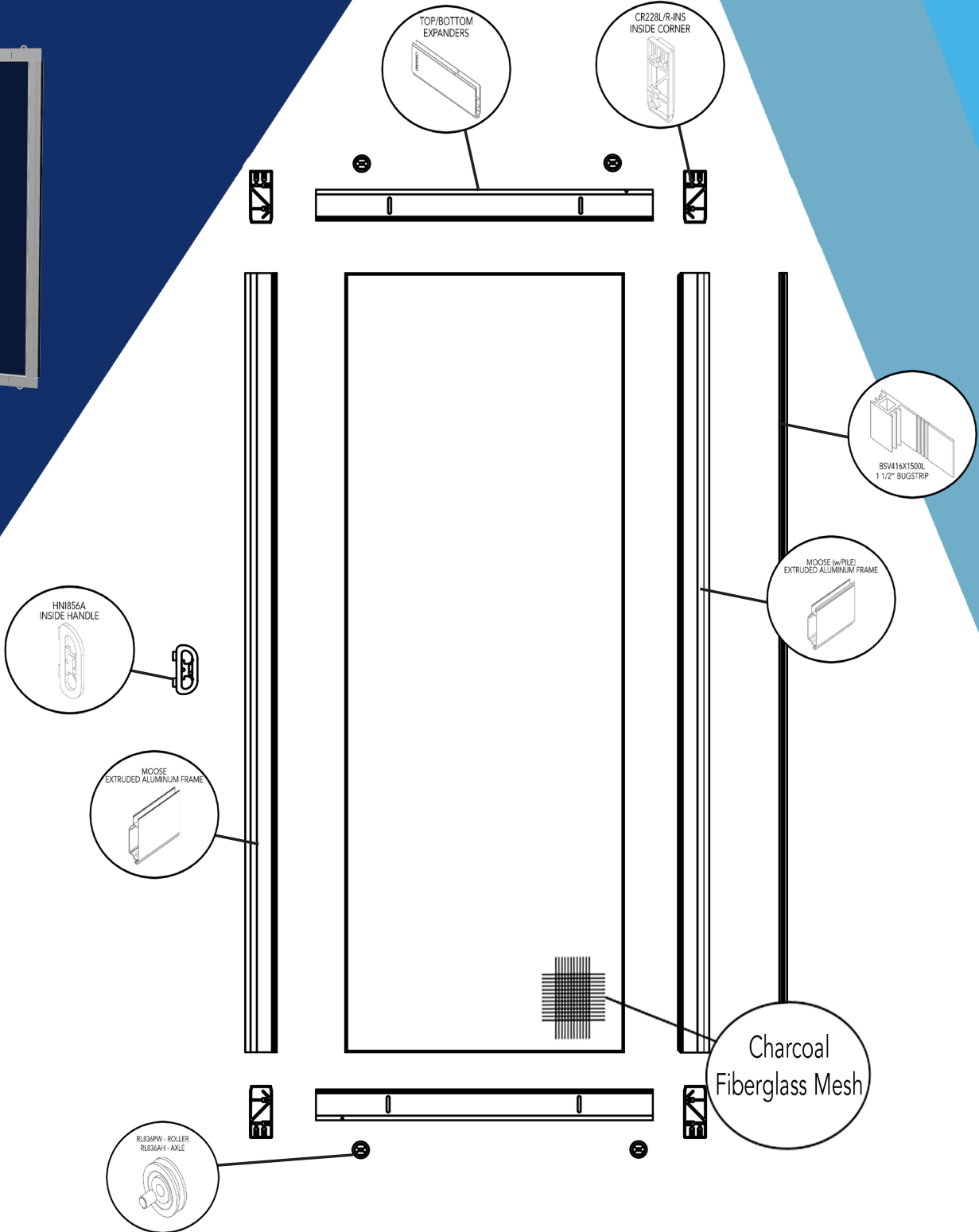

## Standard Colors



Part #	Description	QTY	List Price
MOOSEMFIT	Knock-Down Ultimate Multi-Fit Patio Door Screen	1 per box	\$1.6187/UI

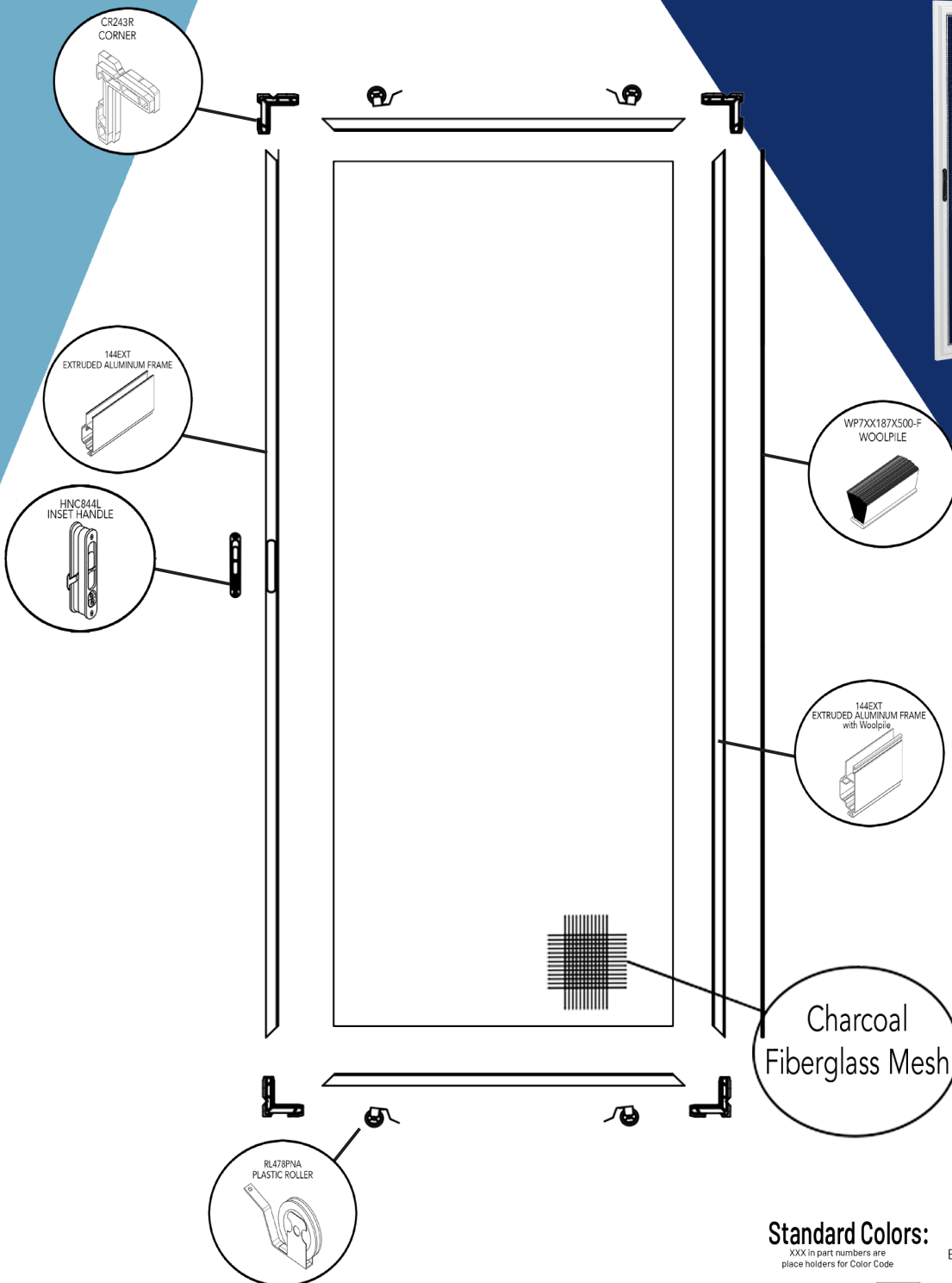

### Standard Colors:

XXX in part numbers are place holders for Color Code

White (C01)		Black (L48)	
Almond (A29)		Clay (A22)	
		Bronze (B16)	

Part #	Description	QTY	List Price
KD.144EXT	Unassembled (packaging included)	1 per box	\$2.69/UI

# Customizable Distributor Knock-Down Kit

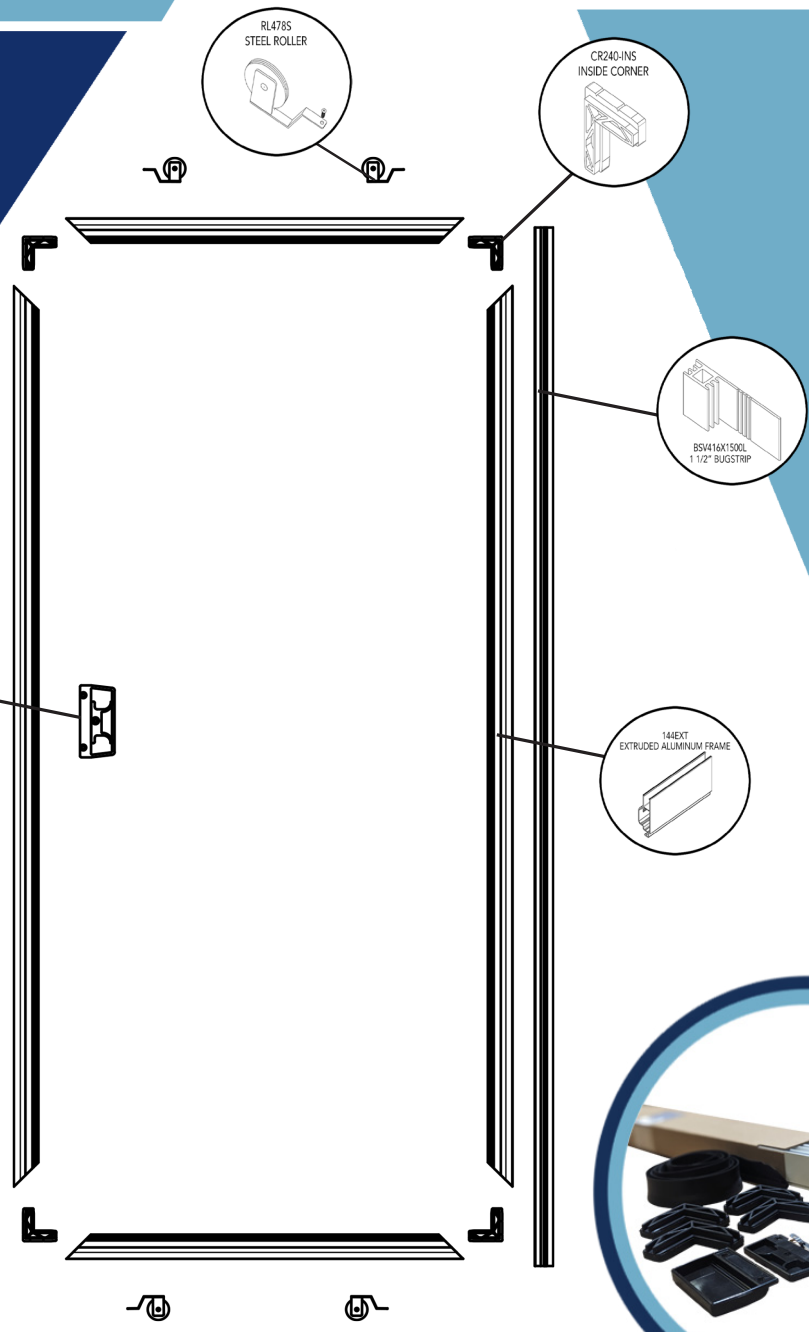
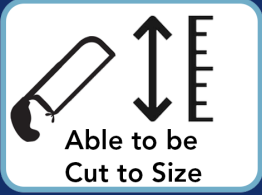

### Standard Colors:

XXX in part numbers are  
placeholders for Color Code



**\*\*Mesh, Spline, and Tool are NOT included**

Part #	Description	QTY	List Price More Than 12	List price 12 or Less (Includes Shipping Tube)
144KDTB1-XXX	31" x 81"	1 per box	\$244.83 ea	\$344.83 ea
144KDTB1-XXX	33" x 81"	1 per box	\$249.20 ea	\$349.20 ea
144KDTB1-XXX	37" x 81"	1 per box	\$257.95 ea	\$357.95 ea
144KDTB1-XXX	39" x 81"	1 per box	\$262.32 ea	\$362.32 ea
144KDTB1-XXX	49" x 81"	1 per box	\$284.18 ea	\$384.18 ea
144KDTB1-XXX	33" x 97"	1 per box	\$284.18 ea	\$384.18 ea
144KDTB1-XXX	37" x 97"	1 per box	\$292.92 ea	\$392.92 ea
144KDTB1-XXX	39" x 97"	1 per box	\$297.30 ea	\$397.30 ea
144KDTB1-XXX	49" x 97"	1 per box	\$319.16 ea	\$419.16 ea

**When purchasing more than 12 units, up to a maximum of 175, a packaging charge of \$275.79 list will apply.  
When purchasing 12 units or less, they will be shipped individually in a shipping tube.**

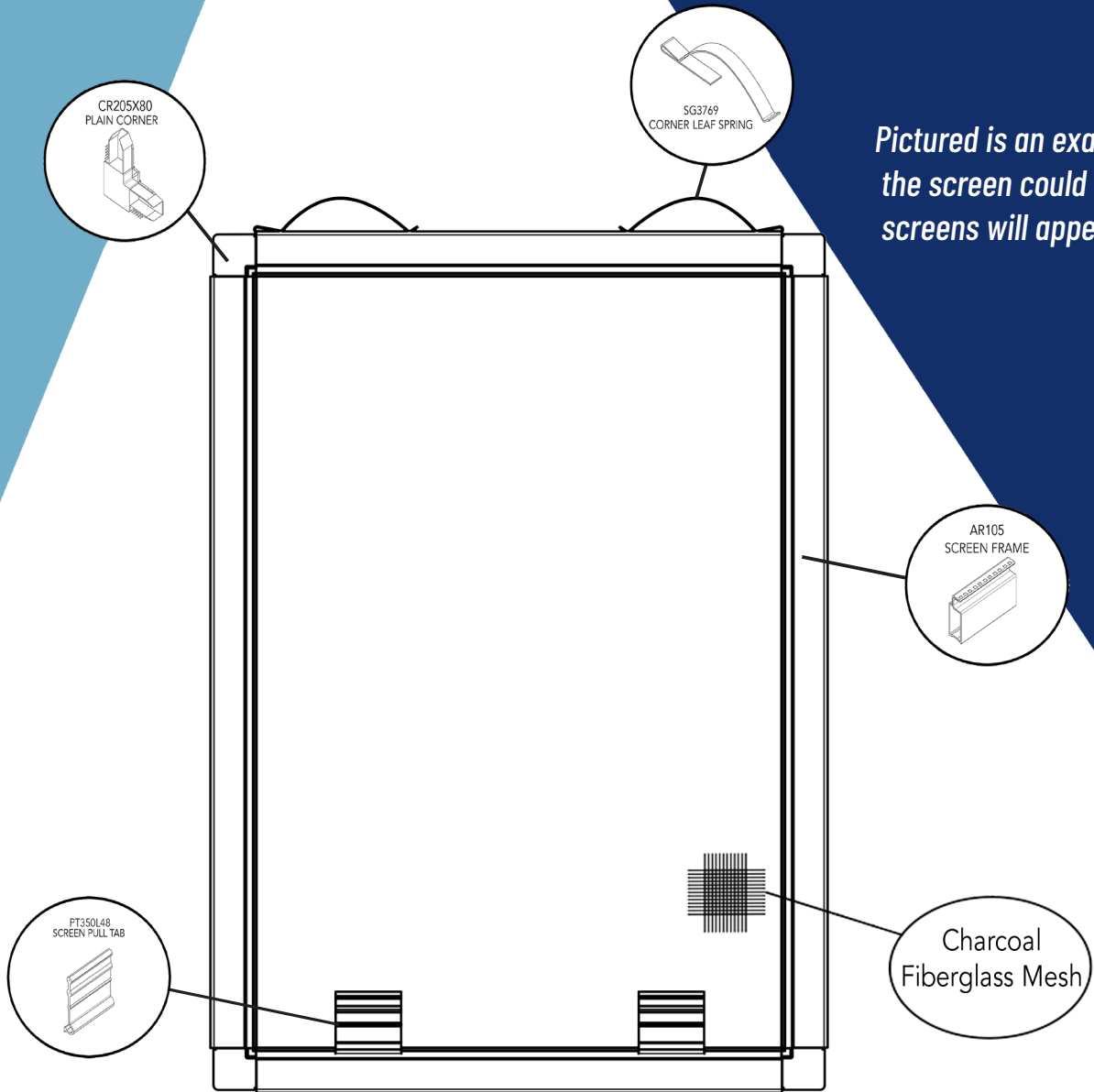

*Pictured is an example of how the screen could look. Not all screens will appear this way.*

### Available Colors



Part #	Description	Color	Length	List Price
FG-WDKIT36-C	36" Replacement Kit, No Mesh	White	36"	\$35.50
FG-WDKIT36-B	36" Replacement Kit, No Mesh	Bronze	36"	\$35.50
FG-WDKIT48-C	48" Replacement Kit, No Mesh	White	48"	\$39.90
FG-WDKIT48-B	48" Replacement Kit, No Mesh	Bronze	48"	\$39.90
FG-WDKIT60-C	60" Replacement Kit, No Mesh	White	60"	\$44.38
FG-WDKIT60-B	60" Replacement Kit, No Mesh	Bronze	60"	\$44.38
FG-WDKIT36M-C	36" Replacement Kit, Mesh Included	White	36"	\$40.36
FG-WDKIT36M-B	36" Replacement Kit, Mesh Included	Bronze	36"	\$40.36
FG-WDKIT48M-C	48" Replacement Kit, Mesh Included	White	48"	\$48.52
FG-WDKIT48M-B	48" Replacement Kit, Mesh Included	Bronze	48"	\$48.52
FG-WDKIT60M-C	60" Replacement Kit, Mesh Included	White	60"	\$57.86
FG-WDKIT60M-B	60" Replacement Kit, Mesh Included	Bronze	60"	\$57.86

\*\*Available in bulk quantities





# COMPONENTS



# America's Total Screen Authority

## BUG STRIPS

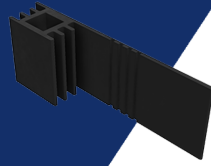

BSV350X1500-L

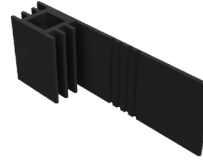

BSV416X1500-L

Part #	Description	Color	Length	UOM	QTY	List Price Bulk
BSV350X1500-L	1.5" Bug Strip	Black	286'	Roll	286'	\$217.20
BSV416X1500-L	1.5" Bug Strip	Black	286'	Roll	286'	\$391.36

## CAPS



PL308-XXX

Part #	Description	Color	UOM	QTY	List Price Bulk	List Price 100 Pack
PL308-XXX	Plunger Cap	Standard	Box	10,000	\$1,751.20	\$75.51

## CLIPS

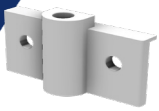

CL3420-XXX



CL555L-L48



CL555R-L48



CL556-L48



CL4119LC



CL4119RC

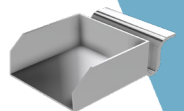

CLS209

Part #	Description	Color	UOM	QTY	List Price Bulk	List Price 100 Pack
CL3420-XXX	Plunger Housing	White or Bronze	Box	1,000	\$880.00	\$146.00
CL555L-L48	Left Swivel Clip	Mill	Box	3,000	\$7,788.00	\$317.60
CL555R-L48	Right Swivel Clip	Mill	Box	3,000	\$7,788.00	\$317.60
CL556-L48	Top Swivel Clip	Mill	Box	5,000	\$11,660.00	\$291.20
CL4119LC	Swivel Clip (Left)	White	Box	2,000	\$2,686.32	\$171.52
CL4119RC	Swivel Clip (Right)	White	Box	2,000	\$2,686.32	\$171.52
CLS209	Cross Bar Clip	Mill	Box	10,000	\$2,200.00	\$80.00

## CROSSBARS

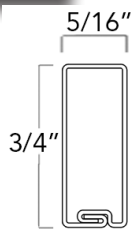

AR368-16-12XXX

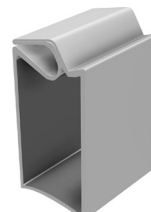
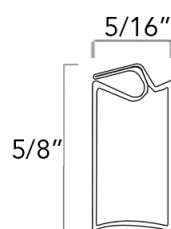

AR109-16-11XXX

### Standard Colors:

XXX in part numbers are place holders for Color Code

White (C01)

Almond (A29)

Black (L48)

Clay (A22)

Bronze (B16)

Part #	Description	Color	Length	UOM	QTY	List Price Bulk
AR368-16-12XXX	Crossbar	Standard	12.5'	Box	152/pcs	\$1,583.36
AR109-16-11XXX	Crossbar	Standard	11.5'	Box	153/pcs	\$1,593.72

## CORNERS

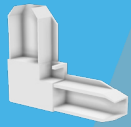

CR201-XXX

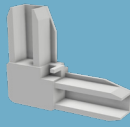

CR202X775-XXX



CR205PSX80-XXX

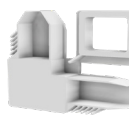

CR205PTX80-XXX

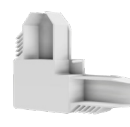

CR205X80-XXX

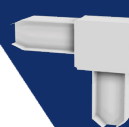

CR232-202L-XXX

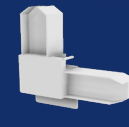

CR232-202R-XXX

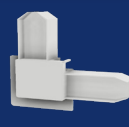

CR232-XXX

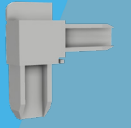

CR233-202L

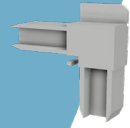

CR233-202R

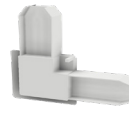

CR233-XXX



CR236FPL-XXX

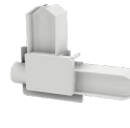

CR236FPR-XXX



CR243L



CR243R



CR245L



CR245R



CR54663-328-INS



CR54665-INS



CR54666-INS



CR54667-INS



CR54668-INS

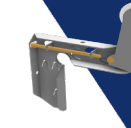

CRS221-USP



CRS221-USS



CR280201-INS



CR201-INS-AL



CR202-INS-AL



CR205-INS-AL



CR624PTX1-XXX

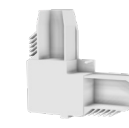

CR205DLX80-XXX

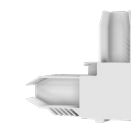

CR205DRX80-XXX

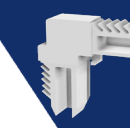

CR205NLX80-XXX



CR205NRX80-XXX

Part #	Description	Color	UOM	QTY	List Price Bulk	List Price 100 Pack
CR201-XXX	Outside Corner	Standard	Box	1,500/pcs	\$1,750.32	\$174.69
CR202X775-XXX	Outside Corner	Standard	Box	1,500/pcs	\$2,277.00	\$209.80
CR205PSX80-XXX	Corner Pull w/Stop	Standard	Box	1,500/pcs	\$605.88	\$98.39
CR205PTX80-XXX	Corner w/Pull	Standard	Box	1,500/pcs	\$605.88	\$98.39
CR205X80-XXX	Plain Corner	Standard	Box	1,500/pcs	\$439.56	\$87.30
CR232-202L-XXX / CR232-202R-XXX	Corner	Standard	Bag	2,000/pcs	\$3,940.64	\$255.03
CR232-XXX	Plain Corner	Standard	Box	1,500/pcs	\$1,267.20	\$142.48
CR233-202L / CR233-202R	Plain Corner	Standard	Box	1,500/pcs	\$2,955.48	\$255.03
CR233-XXX	Plain Corner	Standard	Box	2,500/pcs	\$3,291.20	\$189.65
CR236FPL-XXX / CR236FPR-XXX	Fixed Pin Corner	Standard	Bag	2,000/pcs	\$2,583.68	\$187.18
CR243L / CR243R	Corner	Standard	Box	600/pcs	\$2,824.80	\$528.80
CR245L / CR245R	Corner	Standard	Box	200/pcs	\$1,579.95	\$847.98
CR54663-328-INS	Corner	Mill	Box	1,000/pcs	\$503.36	\$108.34
CR54665-INS	Inside Corner	Mill	Box	2,500/pcs	\$1,357.40	\$112.30
CR54666-INS	Inside Corner	Mill	Box	4,000/pcs	\$2,766.72	\$127.17
CR54667-INS	Corner	Mill	Box	2,000/pcs	\$1,504.80	\$133.24
CR54668-INS	Inside Corner	Mill	Box	4,000/ea	\$3,833.28	\$153.83
CRS221-USP	Corner/Plastic Roller	Standard	Box	250/pcs	\$2,105.40	\$900.16
CRS221-USS	Corner/Steel Roller	Standard	Box	250/pcs	\$2,613.60	\$1,103.44
CR280201-INS	Inside Corner	Mill	Box	3,000/pcs	\$3,062.40	\$160.08
CR201-INS-AL	Inside Corner	Mill	Box	1,000/pcs	\$1,056.00	\$163.60
CR202-INS-AL	Inside Corner	Mill	Box	1,000/pcs	\$1,056.00	\$163.60
CR205-INS-AL	Inside Corner	Mill	Box	1,000/pcs	\$792.00	\$137.20
CR624PTX1-XXX	Pull Tab Corner	Standard	Box	2,500/pcs	\$1,062.60	\$100.50
CR205DLX80-XXX / CR205DRX80-XXX	Dimple Corner	Standard	Box	1,500/pcs	\$439.56	\$87.30
CR205NLX80-XXX / CR205NRX80-XXX	Notched Corner	Standard	Box	1,500/pcs	\$439.56	\$87.30

## HANDLES



Part #	Description	Color	UOM	QTY	List Price Bulk	List Price 100 Pack
HNI824A-L48	Inside Handle w. Latch	Black	Box	1,000/box	\$2,287.12	\$286.71
HNI824I-L48	Outside Handle	Black	Box	1,000/box	\$2,467.52	\$304.75
HNI856A-L48	Inside Handle	Black	Box	500/pcs	\$1,393.04	\$336.61
HNI857-L48	Outside Handle	Black	Box	350/pcs	\$1,045.04	\$356.58
HNC844L-L48	Inset Black Composite Handle, Left	Black	Box	100/pcs	\$1,248.72	\$1,306.72
HNC844R-L48	Inset Black Composite Handle, Right	Black	Box	100/pcs	\$1,248.72	\$1,306.72
HNC845L-L48	Inset Black Composite Handle, Left	Black	Box	100/pcs	\$1,333.20	\$1,391.20
HNC845R-L48	Inset Black Composite Handle, Right	Black	Box	100/pcs	\$1,333.20	\$1,391.20
HN3492AB-L48	Outside Handle	Black	Box	300/pcs	\$2,650.56	\$927.52

## LATCHES



Part #	Description	Color	UOM	QTY	List Price Bulk	List Price 100 Pack
CL10516C	Screen Latch	Standard	Box	1,000/pcs	\$1,268.96	\$184.90
CL082-L48	Swivel Latch	Mill	Box	3,500/pcs	\$1,419.88	\$98.57
HNS481-4	Standard T Latch	Mill	Box	8,000/box	\$10,419.20	\$188.24
HNS841-6	Standard T-Latch	Mill	Box	8,000/box	\$10,419.20	\$188.24
HW1025-XXX	Plastic Slide Latch	White or Black	Box	10,000/box	\$3,784.00	\$95.84
CL145L-S00	Screen Latch	Clear	Box	3,000/pcs	\$1,708.08	\$114.94
CL145R-S00	Screen Latch	Clear	Box	3,000/pcs	\$1,708.08	\$114.94
CL339R	Butterfly Latch	Mill	Box	4,000/pcs	\$9,856.00	\$304.40
CL339L	Butterfly Latch	Mill	Box	4,000/pcs	\$9,856.00	\$304.40

## LEAF SPRINGS

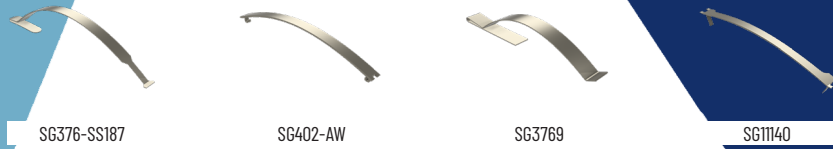

Part #	Description	Color	UOM	QTY	List Price Bulk	List Price 100 Pack
SG376-SS187	Leaf Spring	Mill	Box	6,000/pcs	\$3,080.00	\$181.20
SG402-AW	Leaf Spring	Mill	Box	5,000/pcs	\$1,333.20	\$84.66
SG3769	Leaf Spring	Mill	Box	10,000/pcs	\$3,185.60	\$376.56
SG11140	Overlapping Leaf Spring	Mill	Box	6,500/pcs	\$3,374.80	\$109.92

## PINS



PL1012A-CL

Part #	Description	Color	UOM	QTY	List Price Bulk	List Price 100 Pack
PL1012A-CL	Push Pin	Mill	Box	2,000/pcs	\$520.80	\$86.16

## PLUNGERS



PL315

Part #	Description	Color	UOM	QTY	List Price Bulk	List Price 100 Pack
PL315	Plunger	Mill	Box	2,000/pcs	\$739.20	\$94.96

## PULL TABS



HNP411-XXX



PT350L48



PT342S00



PT349L

Part #	Description	Color	UOM	QTY	List Price Bulk	List Price 100 Pack
HNP411-XXX	Pull Tab	White or Black	Box	2,500/pcs	\$12,760.00	\$568.40
PT342S00	Clear Pull Tab	Clear	Box	1,700/pcs	\$444.31	\$84.14
PT350L48	Pull Tab	Black	Box	4,000/pcs	\$457.60	\$69.44
PT349L	Pull Tab	Black	Box	8,500/pcs	\$2,700.28	\$89.77

## RIVETS

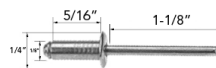

FS527

Part #	Description	Color	UOM	QTY	List Price Bulk	List Price 100 Pack
FS527	Rivet	Mill	Box	10,000/pcs	\$1,592.80	\$73.93

## ROLLERS

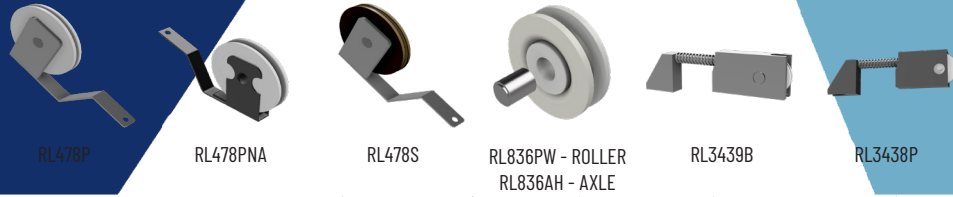

Part #	Description	Color	UOM	QTY	List Price Bulk	List Price 100 Pack
RL478P	Composite Roller	Mill	Box	2,500/box	\$5,280.00	\$269.20
RL478PNA	Plastic Roller	Mill	Box	2,500/box	\$4,290.00	\$229.60
RL478S	Steel Roller	Mill	Box	2,500/box	\$12,650.00	\$564.00
RL836PW	Plastic Roller	White	Box	3,000/Box	\$1,021.68	\$92.06
RL836AH	Steel Axle	Mill	Box	10,000/Box	\$2,112.00	\$79.12
RL3439B	Roller	Mill	Box	600/box	\$5,113.68	\$907.28
RL3438P	Plastic Roller	Mill	Box	600/Box	\$2,325.84	\$442.64
RL3438S	Steel Roller (not shown)	Mill	Box	600/Box	\$3,666.96	\$666.16
RL3438SS	Stainless Steel Roller (not shown)	Mill	Box	600/Box	\$8,461.20	\$1,465.20

## SCREEN FRAMES

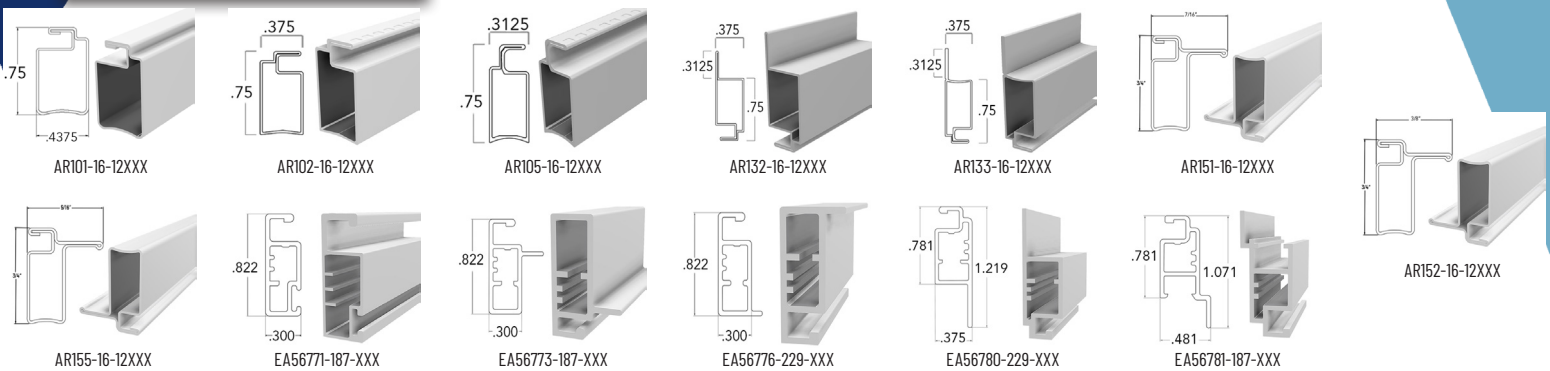

Part #	Description	Color	Length	UOM	QTY	List Price Bulk
AR101-16-12XXX	Screen Frame	Standard	12.5'	Box	112/pcs	\$1,293.64
AR101-24-12XXX	Screen Frame	C01, B16	12.5'	Box	112/pcs	\$2,441.10
AR102-16-12XXX	Screen Frame	Standard	12.5'	Box	128/pcs	\$1,419.08
AR102-24-12XXX	Screen Frame	C01, B16	12.5'	Box	128/pcs	\$2,662.96
AR105-16-12XXX	Screen Frame	Standard	12.5'	Box	152/pcs	\$1,583.72
AR105-24-12XXX	Screen Frame	C01, B16	12.5'	Box	152/pcs	\$3,162.27
AR132-16-12XXX	Flange Screen Frame	Standard	12.5'	Box	105/pcs	\$1,484.36
AR133-16-12XXX	Flange Screen Frame	Standard	12.5'	Box	105/pcs	\$1,525.52
AR151-16-12XXX	Lift Rail	Standard	12.5'	Box	80/pcs	\$1,463.40
AR152-16-12XXX	Lift Rail	C01	12.5'	Box	80/pcs	\$1,439.91
AR155-16-12XXX	Lift Rail	C01, A22, L48	12.5'	Box	70/pcs	\$1,200.56
EA56771-187-XXX	Pile Rail	Standard	15.5'	Box	20/pcs	\$1,297.28
EA56773-187-XXX	Pull Rail	Standard	15.5'	Box	20/pcs	\$1,274.24
EA56776-229-XXX	Edge Stop Rail	Standard	19'	Box	20/pcs	\$1,453.34
EA56780-229-XXX	Flange Rail	Standard	19'	Box	20/pcs	\$1,593.07
EA56781-187-XXX	Short Flange Rail	Standard	15.5'	Box	20/pcs	\$1,365.57

## Standard Colors:

XXX in part numbers are  
place holders for Color Code



## SCREEN FRAMES CONT.

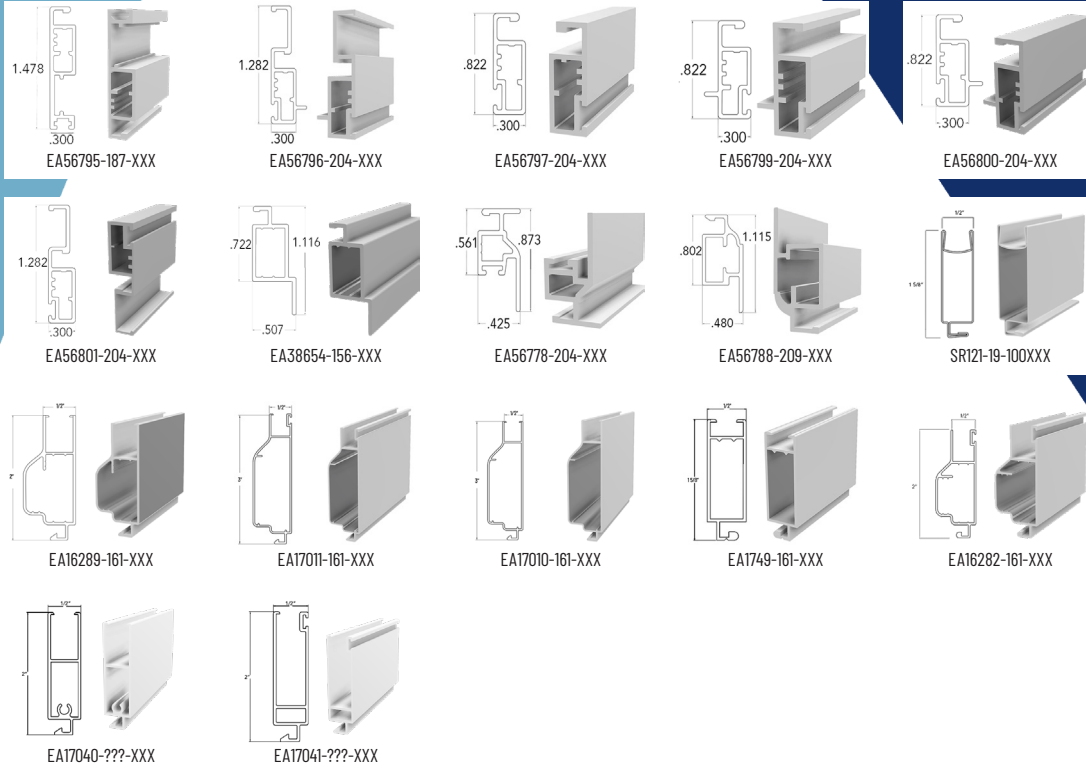

Part #	Description	Color	Length	UOM	QTY	List Price Bulk
EA56795-187-XXX	Latch Rail	Standard	15.5'	Box	20/pcs	\$1,633.25
EA56796-204-XXX	Lift Rail w/Pile and Stop	Standard	17'	Box	20/pcs	\$1,566.73
EA56797-204-XXX	Pile Rail	Standard	17'	Box	20/pcs	\$1,297.28
EA56799-204-XXX	Stop Rail w/Pile	Standard	17'	Box	20/pcs	\$1,464.10
EA56800-204-XXX	Stop Rail w/Pile	Standard	17'	Box	20/pcs	\$1,463.21
EA56801-204-XXX	Lift Rail w/Pile	Standard	17'	Box	20/pcs	\$1,542.49
EA38654-156-XXX	Casement Frame	Standard	13'	Box	20/pcs	\$1,261.26
EA56778-204-XXX	Screen Frame	Standard	17'	Box	20/ea	\$1,352.80
EA56788-209-XXX	Casement Frame	Standard	17.5'	Box	20/pcs	\$1,721.03
SR121-19-100XXX	121 Steel Frame	Standard (No Black)	8.1'	Box	20/pcs	\$971.52
EA1749-161-XXX	199EXT Extruded Aluminum Frame	Standard	13.5'	Box	10/pcs	\$1,248.77
EA16282-161-XXX	144EXT Extruded Aluminum Frame with Woolpile	Standard	13.5'	Box	10/pcs	\$1,267.90
EA16289-161-XXX	144EXT Extruded Aluminum Frame	Standard	13.5'	Box	10/pcs	\$1,267.90
EA17011-161-XXX	MOOSE Extruded Aluminum Frame with Woolpile	Standard	13.5'	Box	10/pcs	\$1,816.44
EA17010-161-XXX	MOOSE Extruded Aluminum Frame	Standard	13.5'	Box	10/pcs	\$1,747.60
EA17040-133-XXX	Extruded Aluminum Frame	See Chart	133"	Box	10/pcs	\$633.68
EA17041-133-XXX	Extruded Aluminum Frame	See Chart	133"	Box	10/pcs	\$599.77



## SCREEN MESH

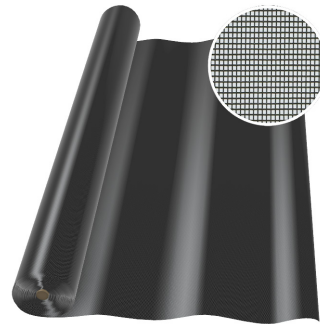

CHAR FIBER MESH

\* See page 6 for upgraded mesh options





Contact Inside Sales for Availability  
 Two-Week Lead Time  
 1-800-949-4174  
[www.RITESCREEN.com](http://www.RITESCREEN.com)  
[insidesales@ritescreen.com](mailto:insidesales@ritescreen.com)

CHARCOAL - 100'			CHARCOAL - 600'			GREY - 100'			GREY - 600'		
Part #	Width	List Price	Part #	Width	List Price	Part #	Width	List Price	Part #	Width	List Price
MSFG24X100-L00	24"	\$177.58	MSFG24X600-L00	24"	\$712.80	MSFG24X100-F32	24"	\$185.98	MSFG24X600-F32	24"	\$726.00
MSFG26X100-L00	26"	\$192.37	MSFG26X600-L00	26"	\$772.20	MSFG26X100-F32	26"	\$201.47	MSFG26X600-F32	26"	\$786.50
MSFG28X100-L00	28"	\$207.17	MSFG28X600-L00	28"	\$831.60	MSFG28X100-F32	28"	\$216.97	MSFG28X600-F32	28"	\$847.00
MSFG30X100-L00	30"	\$221.97	MSFG30X600-L00	30"	\$891.00	MSFG30X100-F32	30"	\$232.47	MSFG30X600-F32	30"	\$907.50
MSFG32X100-L00	32"	\$236.77	MSFG32X600-L00	32"	\$950.40	MSFG32X100-F32	32"	\$247.97	MSFG32X600-F32	32"	\$968.00
MSFG34X100-L00	34"	\$251.57	MSFG34X600-L00	34"	\$1,009.80	MSFG34X100-F32	34"	\$263.47	MSFG34X600-F32	34"	\$1,028.50
MSFG36X100-L00	36"	\$266.36	MSFG36X600-L00	36"	\$1,069.20	MSFG36X100-F32	36"	\$278.96	MSFG36X600-F32	36"	\$1,089.00
MSFG38X100-L00	38"	\$281.16	MSFG38X600-L00	38"	\$1,128.60	MSFG38X100-F32	38"	\$294.46	MSFG38X600-F32	38"	\$1,149.50
MSFG40X100-L00	40"	\$295.96	MSFG40X600-L00	40"	\$1,188.00	MSFG40X100-F32	40"	\$309.96	MSFG40X600-F32	40"	\$1,210.00
MSFG42X100-L00	42"	\$310.76	MSFG42X600-L00	42"	\$1,247.40	MSFG42X100-F32	42"	\$325.46	MSFG42X600-F32	42"	\$1,270.50
MSFG44X100-L00	44"	\$325.56	MSFG44X600-L00	44"	\$1,306.80	MSFG44X100-F32	44"	\$340.96	MSFG44X600-F32	44"	\$1,331.00
MSFG46X100-L00	46"	\$340.35	MSFG46X600-L00	46"	\$1,366.20	MSFG46X100-F32	46"	\$356.45	MSFG46X600-F32	46"	\$1,391.50
MSFG48X100-L00	48"	\$355.15	MSFG48X600-L00	48"	\$1,425.60	MSFG48X100-F32	48"	\$371.95	MSFG48X600-F32	48"	\$1,452.00
MSFG50X100-L00	50"	\$369.95	MSFG50X600-L00	50"	\$1,485.00	MSFG50X100-F32	50"	\$387.45	MSFG50X600-F32	50"	\$1,512.50
MSFG52X100-L00	52"	\$384.75	MSFG52X600-L00	52"	\$1,544.40	MSFG52X100-F32	52"	\$402.95	MSFG52X600-F32	52"	\$1,573.00
MSFG54X100-L00	54"	\$399.55	MSFG54X600-L00	54"	\$1,603.80	MSFG54X100-F32	54"	\$418.45	MSFG54X600-F32	54"	\$1,633.50
MSFG56X100-L00	56"	\$414.34	MSFG56X600-L00	56"	\$1,663.20	MSFG56X100-F32	56"	\$433.94	MSFG56X600-F32	56"	\$1,694.00
MSFG58X100-L00	58"	\$429.14	MSFG58X600-L00	58"	\$1,722.60	MSFG58X100-F32	58"	\$449.44	MSFG58X600-F32	58"	\$1,754.50
MSFG60X100-L00	60"	\$443.94	MSFG60X600-L00	60"	\$1,782.00	MSFG60X100-F32	60"	\$464.94	MSFG60X600-F32	60"	\$1,815.00
MSFG62X100-L00	62"	\$458.74	MSFG62X600-L00	62"	\$1,841.40	MSFG62X100-F32	62"	\$480.44	MSFG62X600-F32	62"	\$1,875.50
MSFG64X100-L00	64"	\$473.54	MSFG64X600-L00	64"	\$1,900.80	MSFG64X100-F32	64"	\$495.94	MSFG64X600-F32	64"	\$1,936.00
MSFG66X100-L00	66"	\$488.33	MSFG66X600-L00	66"	\$1,960.20	MSFG66X100-F32	66"	\$511.43	MSFG66X600-F32	66"	\$1,996.50
MSFG68X100-L00	68"	\$503.13	MSFG68X600-L00	68"	\$2,019.60	MSFG68X100-F32	68"	\$526.93	MSFG68X600-F32	68"	\$2,057.00
MSFG70X100-L00	70"	\$517.93	MSFG70X600-L00	70"	\$2,079.00	MSFG70X100-F32	70"	\$542.43	MSFG70X600-F32	70"	\$2,117.50
MSFG72X100-L00	72"	\$532.73	MSFG72X600-L00	72"	\$2,138.40	MSFG72X100-F32	72"	\$557.93	MSFG72X600-F32	72"	\$2,178.00
MSFG74X100-L00	74"	\$547.53	MSFG74X600-L00	74"	\$2,197.80	MSFG74X100-F32	74"	\$573.43	MSFG74X600-F32	74"	\$2,238.50
MSFG76X100-L00	76"	\$562.32	MSFG76X600-L00	76"	\$2,257.20	MSFG76X100-F32	76"	\$588.92	MSFG76X600-F32	76"	\$2,299.00
MSFG78X100-L00	78"	\$577.12	MSFG78X600-L00	78"	\$2,316.60	MSFG78X100-F32	78"	\$604.42	MSFG78X600-F32	78"	\$2,359.50
MSFG80X100-L00	80"	\$591.92	MSFG80X600-L00	80"	\$2,376.00	MSFG80X100-F32	80"	\$619.92	MSFG80X600-F32	80"	\$2,420.00
MSFG82X100-L00	82"	\$606.72	MSFG82X600-L00	82"	\$2,435.40	MSFG82X100-F32	82"	\$635.42	MSFG82X600-F32	82"	\$2,480.50
MSFG84X100-L00	84"	\$621.52	MSFG84X600-L00	84"	\$2,494.80	MSFG84X100-F32	84"	\$650.92	MSFG84X600-F32	84"	\$2,541.00

## SCREEN MESH

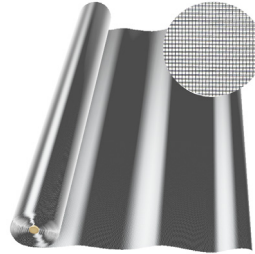

Contact Inside Sales for Availability  
Two-Week Lead Time  
1-800-949-4174  
www.RITESCREEN.com  
insidesales@ritescreen.com



ALUMINUM WIRE MESH

ALUMINUM BLACK - 100'		
Part #	Width	List Price
MSAL18X100-L48	18"	\$248.82
MSAL20X100-L48	20"	\$276.47
MSAL22X100-L48	22"	\$304.11
MSAL24X100-L48	24"	\$331.76
MSAL26X100-L48	26"	\$359.41
MSAL28X100-L48	28"	\$387.05
MSAL30X100-L48	30"	\$414.70
MSAL32X100-L48	32"	\$442.35
MSAL34X100-L48	34"	\$469.99
MSAL36X100-L48	36"	\$497.64
MSAL38X100-L48	38"	\$525.29
MSAL40X100-L48	40"	\$552.93
MSAL42X100-L48	42"	\$580.58
MSAL44X100-L48	44"	\$608.23
MSAL46X100-L48	46"	\$635.87
MSAL48X100-L48	48"	\$663.52
MSAL50X100-L48	50"	\$746.17
MSAL52X100-L48	52"	\$776.01
MSAL54X100-L48	54"	\$805.86
MSAL56X100-L48	56"	\$835.71
MSAL58X100-L48	58"	\$865.55
MSAL60X100-L48	60"	\$895.40
MSAL62X100-L48	62"	\$925.25
MSAL64X100-L48	64"	\$955.09
MSAL66X100-L48	66"	\$984.94
MSAL68X100-L48	68"	\$1,014.79
MSAL70X100-L48	70"	\$1,044.63
MSAL72X100-L48	72"	\$1,074.48

ALUMINUM CHARCOAL - 100'		
Part #	Width	List Price
MSAL18X100-L00	18"	\$248.82
MSAL20X100-L00	20"	\$276.47
MSAL22X100-L00	22"	\$304.11
MSAL24X100-L00	24"	\$331.76
MSAL26X100-L00	26"	\$359.41
MSAL28X100-L00	28"	\$387.05
MSAL30X100-L00	30"	\$414.70
MSAL32X100-L00	32"	\$442.35
MSAL34X100-L00	34"	\$469.99
MSAL36X100-L00	36"	\$497.64
MSAL38X100-L00	38"	\$525.29
MSAL40X100-L00	40"	\$552.93
MSAL42X100-L00	42"	\$580.58
MSAL44X100-L00	44"	\$608.23
MSAL46X100-L00	46"	\$635.87
MSAL48X100-L00	48"	\$663.52
MSAL50X100-L00	50"	\$746.17
MSAL52X100-L00	52"	\$776.01
MSAL54X100-L00	54"	\$805.86
MSAL56X100-L00	56"	\$835.71
MSAL58X100-L00	58"	\$865.55
MSAL60X100-L00	60"	\$895.40
MSAL62X100-L00	62"	\$925.25
MSAL64X100-L00	64"	\$955.09
MSAL66X100-L00	66"	\$984.94
MSAL68X100-L00	68"	\$1,014.79
MSAL70X100-L00	70"	\$1,044.63
MSAL72X100-L00	72"	\$1,074.48

ALUMINUM BRITE - 100'		
Part #	Width	List Price
MSAL18X100-S01	18"	\$237.20
MSAL20X100-S01	20"	\$263.56
MSAL22X100-S01	22"	\$289.92
MSAL24X100-S01	24"	\$316.27
MSAL26X100-S01	26"	\$342.63
MSAL28X100-S01	28"	\$368.98
MSAL30X100-S01	30"	\$395.34
MSAL32X100-S01	32"	\$421.70
MSAL34X100-S01	34"	\$448.05
MSAL36X100-S01	36"	\$474.41
MSAL38X100-S01	38"	\$500.76
MSAL40X100-S01	40"	\$527.12
MSAL42X100-S01	42"	\$553.48
MSAL44X100-S01	44"	\$579.83
MSAL46X100-S01	46"	\$606.19
MSAL48X100-S01	48"	\$632.54
MSAL50X100-S01	50"	\$713.90
MSAL52X100-S01	52"	\$742.46
MSAL54X100-S01	54"	\$771.01
MSAL56X100-S01	56"	\$799.57
MSAL58X100-S01	58"	\$828.12
MSAL60X100-S01	60"	\$856.68
MSAL62X100-S01	62"	\$885.24
MSAL64X100-S01	64"	\$913.79
MSAL66X100-S01	66"	\$942.35
MSAL68X100-S01	68"	\$970.90
MSAL70X100-S01	70"	\$999.46
MSAL72X100-S01	72"	\$1,028.02

## SCREEN MESH

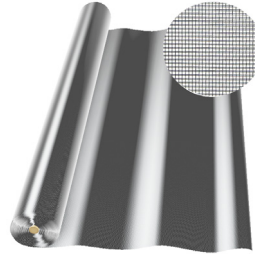

ALUMINUM WIRE MESH



Contact Inside Sales for Availability  
Two-Week Lead Time  
1-800-949-4174  
www.RITESCREEN.com  
insidesales@ritescreen.com

ALUMINUM BLACK - 300'		
Part #	Width	List Price
MSAL18X300-L48	18"	\$746.46
MSAL20X300-L48	20"	\$829.40
MSAL22X300-L48	22"	\$912.34
MSAL24X300-L48	24"	\$995.28
MSAL26X300-L48	26"	\$1,078.22
MSAL28X300-L48	28"	\$1,161.16
MSAL30X300-L48	30"	\$1,244.10
MSAL32X300-L48	32"	\$1,327.04
MSAL34X300-L48	34"	\$1,409.98
MSAL36X300-L48	36"	\$1,492.92
MSAL38X300-L48	38"	\$1,575.86
MSAL40X300-L48	40"	\$1,658.80
MSAL42X300-L48	42"	\$1,741.74
MSAL44X300-L48	44"	\$1,824.68
MSAL46X300-L48	46"	\$1,907.62
MSAL48X300-L48	48"	\$1,990.56
MSAL50X300-L48	50"	\$2,238.50
MSAL52X300-L48	52"	\$2,328.04
MSAL54X300-L48	54"	\$2,417.58
MSAL56X300-L48	56"	\$2,507.12
MSAL58X300-L48	58"	\$2,596.66
MSAL60X300-L48	60"	\$2,686.20
MSAL62X300-L48	62"	\$2,775.74
MSAL64X300-L48	64"	\$2,865.28
MSAL66X300-L48	66"	\$2,954.82
MSAL68X300-L48	68"	\$3,044.36
MSAL70X300-L48	70"	\$3,133.90
MSAL72X300-L48	72"	\$3,223.44

ALUMINUM CHARCOAL - 300'		
Part #	Width	List Price
MSAL18X300-L00	18"	\$746.46
MSAL20X300-L00	20"	\$829.40
MSAL22X300-L00	22"	\$912.34
MSAL24X300-L00	24"	\$995.28
MSAL26X300-L00	26"	\$1,078.22
MSAL28X300-L00	28"	\$1,161.16
MSAL30X300-L00	30"	\$1,244.10
MSAL32X300-L00	32"	\$1,327.04
MSAL34X300-L00	34"	\$1,409.98
MSAL36X300-L00	36"	\$1,492.92
MSAL38X300-L00	38"	\$1,575.86
MSAL40X300-L00	40"	\$1,658.80
MSAL42X300-L00	42"	\$1,741.74
MSAL44X300-L00	44"	\$1,824.68
MSAL46X300-L00	46"	\$1,907.62
MSAL48X300-L00	48"	\$1,990.56
MSAL50X300-L00	50"	\$2,238.50
MSAL52X300-L00	52"	\$2,328.04
MSAL54X300-L00	54"	\$2,417.58
MSAL56X300-L00	56"	\$2,507.12
MSAL58X300-L00	58"	\$2,596.66
MSAL60X300-L00	60"	\$2,686.20
MSAL62X300-L00	62"	\$2,775.74
MSAL64X300-L00	64"	\$2,865.28
MSAL66X300-L00	66"	\$2,954.82
MSAL68X300-L00	68"	\$3,044.36
MSAL70X300-L00	70"	\$3,133.90
MSAL72X300-L00	72"	\$3,223.44

ALUMINUM BRITE - 300'		
Part #	Width	List Price
MSAL18X300-S01	18"	\$711.61
MSAL20X300-S01	20"	\$790.68
MSAL22X300-S01	22"	\$869.75
MSAL24X300-S01	24"	\$948.82
MSAL26X300-S01	26"	\$1,027.88
MSAL28X300-S01	28"	\$1,106.95
MSAL30X300-S01	30"	\$1,186.02
MSAL32X300-S01	32"	\$1,265.09
MSAL34X300-S01	34"	\$1,344.16
MSAL36X300-S01	36"	\$1,423.22
MSAL38X300-S01	38"	\$1,502.29
MSAL40X300-S01	40"	\$1,581.36
MSAL42X300-S01	42"	\$1,660.43
MSAL44X300-S01	44"	\$1,739.50
MSAL46X300-S01	46"	\$1,818.56
MSAL48X300-S01	48"	\$1,897.63
MSAL50X300-S01	50"	\$2,141.70
MSAL52X300-S01	52"	\$2,227.37
MSAL54X300-S01	54"	\$2,313.04
MSAL56X300-S01	56"	\$2,398.70
MSAL58X300-S01	58"	\$2,484.37
MSAL60X300-S01	60"	\$2,570.04
MSAL62X300-S01	62"	\$2,655.71
MSAL64X300-S01	64"	\$2,741.38
MSAL66X300-S01	66"	\$2,827.04
MSAL68X300-S01	68"	\$2,912.71
MSAL70X300-S01	70"	\$2,998.38
MSAL72X300-S01	72"	\$3,084.05

**ALL AVAILABLE MESH TYPES & SIZES**

STANDARD FIBERGLASS MSFG		
100 FT	CHAR(L00) SQFT LIST	\$0.8879
100 FT	GREY(F32) SQFT LIST	\$0.9298
AVAILABLE WIDTHS		
24-26-28-30-32-34-36-38-40-42-44-46-48-50-52-54-56-58-60-62-64-68-70-72-74-76-78-80-82-84		

BETTERVUE MSBV		
100 FT	CHAR(L00) SQFT LIST	\$1.1300
600 FT ROM	CHAR(L00) SQFT LIST	\$ .7137
AVAILABLE WIDTHS		
(100ft) 24-28-30-32-36-40-42-48-60-72-84-96-108		
(600ft) 18-20-22-24-26-28-30-32-34-36-38-40-42-44-46-48-50-52-54-56-59-60-62-64-66-68-70-72		

ULTRAVUE MSUV		
100 FT	CHAR(L00) SQFT LIST	\$2.0400
300 FT ROM	CHAR(L00) SQFT LIST	\$1.6896
AVAILABLE WIDTHS		
24-30-36-48-60-72		

ALUMINUM MSAL		
100 FT	CHAR(L00) SQFT LIST	\$1.6600
100 FT	BLACK(L48) SQFT LIST	\$1.6600
100 FT	BRITE(S01) SQFT LIST	\$1.5800
AVAILABLE WIDTHS		
18-20-22-24-26-28-30-32-34-36-38-40-42-44-46-48-50-52-54-56-58-60-62-64-68-70-72		

FIBERGLASS 18 X 14 POOL & PATIO MSPP		
100 FT	CHAR(L00) SQFT LIST	\$1.3500
100 FT	GREY(F32) SQFT LIST	\$1.3900
AVAILABLE WIDTHS		
36-48-60-72-78-84-90-96-102-108-132-CHAR ONLY-66-78-90-102-132 SP REQUEST 120 CHAR		

FIBERGLASS 20 X 20 NO-SEE-UM MSNF		
100 FT	CHAR (L00)SQFT LIST	\$2.1800
100 FT	GREY(F32) SQFT LIST	\$2.2200
AVAILABLE WIDTHS		
36-48-60-72-84-96-108-132-CHAR ONLY-96-108-132 SP REQUEST 120 CHAR		

TUFFSCREEN NO-SEE-UM MSNP		
100 FT	BLACK(L48) SQFT LIST	\$3.5300
AVAILABLE WIDTHS		
36-48-60-72-84-96-108-120-132		

ALUM TINY INSECT SCREEN MSTI		
100 FT	BLACK(L48) SQFT LIST	\$3.4900
AVAILABLE WIDTHS		
36-48-60-72		

PETSREEN MSPT		
100 FT	BLACK(L48) SQFT LIST	\$3.4900
100 FT	GREY(F32) SQFT LIST	\$3.4900
AVAILABLE WIDTHS		
30-36-48-60 (72 & 96 IN BLACK ONLY)		

TUFFSCREEN POLY MSTs		
100 FT	BLACK(L48) SQFT LIST	\$3.2600
AVAILABLE WIDTHS		
36-48-60-72-84-96-108-120-132		

SEEVUE STAINLESS MSSV		
100 FT	BLACK(L48) SQFT LIST	\$10.5400
AVAILABLE WIDTHS		
36-48-60		

BRONZE SCREEN MSCO		
100 FT	BRONZE(B16) SQFT LIST	\$11.7900
AVAILABLE WIDTHS		
24-30-36-42-48-60-72		

SUNSCREEN MSSN		
100 FT	CHAR(L00) SQFT LIST	\$3.1600
AVAILABLE WIDTHS		
36-48-60-72-84-96		

SUNTEX 80 MSSE8		
100 FT	BLACK(L48) SQFT LIST	\$4.0100
100 FT	BROWN(B00) SQFT LIST	\$4.0100
100 FT	GREY(F32) SQFT LIST	\$4.0100
100 FT	BEIGE(A12) SQFT LIST	\$4.0100
100 FT	STUCCO(A53) SQFT LIST	\$4.0100
100 FT	DK BRZ (B35)SQFT LIST	\$4.0100
AVAILABLE WIDTHS		
36-48-60-72-96-120		

SUNTEX 90 MSSE9		
100 FT	BLACK(L48) SQFT LIST	\$4.9900
100 FT	BROWN(B00) SQFT LIST	\$4.9900
100 FT	GREY(F32) SQFT LIST	\$4.9900
100 FT	BEIGE(A12) SQFT LIST	\$4.9900
100 FT	STUCCO(A53) SQFT LIST	\$4.9900
100 FT	DK BRZ(B35) SQFT LIST	\$4.9900
AVAILABLE WIDTHS		
36-48-60-72-96-120		

SUNTEX 95 MSSE5		
90 FT	BLACK(L48) SQFT LIST	\$6.6700
90 FT	STUCCO(A53) SQFT LIST	\$6.6700
90 FT	DK BRZ(B35) SQFT LIST	\$6.6700
90 FT	WHITE(C01) SQFT LIST	\$6.6700
90 FT	WHT/GRY(CF1) SQFT LIST	\$6.6700
90 FT	SAND(A52) SQFT LIST	\$6.6700
90 FT	ALPACA(A50) SQFT LIST	\$6.6700
90 FT	CHESTNUT(B10) SQFT LIST	\$6.6700
90 FT	MOCHA(B09) SQFT LIST	\$6.6700
90 FT	CARBON(F05) SQFT LIST	\$6.6700
AVAILABLE WIDTHS		
126		

SUNTEX 97 MSSE7		
90 FT	BLACK(L48) SQFT LIST	\$7.1800
90 FT	STUCCO(A53) SQFT LIST	\$7.1800
90 FT	DK BRZ(B35) SQFT LIST	\$7.1800
90 FT	WHITE(C01) SQFT LIST	\$7.1800
90 FT	WHT/GRY(CF1) SQFT LIST	\$7.1800
90 FT	SAND(A52) SQFT LIST	\$7.1800
90 FT	ALPACA(A50) SQFT LIST	\$7.1800
90 FT	CHESTNUT(B10) SQFT LIST	\$7.1800
90 FT	MOCHA(B09) SQFT LIST	\$7.1800
90 FT	CARBON(F05) SQFT LIST	\$7.1800
AVAILABLE WIDTHS		
126		

SOLAR INSECT SCREENING MSSI		
100 FT	CHAR(L00) SQFT LIST	\$3.1600
100 FT	GREY(F32) SQFT LIST	\$3.1600
100 FT	BRONZE(B16) SQFT LIST	\$3.1600
AVAILABLE WIDTHS		
36-48-60-72-84-96		

SUPER SOLAR SCREENING + MSSU		
100 FT	CHAR(L00) SQFT LIST	\$4.8700
AVAILABLE WIDTHS		
36-48-60-84		

Part Number =

Mesh type abbreviation + width + X + length + dash color code  
**Example: MSNP36X100-L48**

## SPLINE



Foam Spline

Part #	Description	Color	Length	UOM	QTY	List Price
SPFRD130-BX-L	.130" Diameter Foam Spline	Black	8,000'	Box	8,000'	\$506.88
SPFRD135-BX-L	.135" Diameter Foam Spline	Black	8,000'	Box	8,000'	\$598.40
SPFRD140-BX-L	.140" Diameter Foam Spline	Black	8,000'	Box	8,000'	\$612.48
SPFRD150-BX-L	.150" Diameter Foam Spline	Black	6,000'	Box	6,000'	\$559.68
SPFRD160-BX-L	.160" Diameter Foam Spline	Black	6,000'	Box	6,000'	\$570.24
SPFRD165-BX-L	.165" Diameter Foam Spline	Black	6,000'	Box	6,000'	\$580.80
SPFRD170-BX-L	.170" Diameter Foam Spline	Black	5,000'	Box	5,000'	\$492.80
SPFRD175-BX-L	.175" Diameter Foam Spline	Black	5,000'	Box	5,000'	\$528.00

## SPRINGS



SG10497



SG412

Part #	Description	UOM	QTY	List Price Bulk	List Price 100 Pack
SG10497	Spring & Dog Assembly	Box	5,000/pcs	\$3,493.60	\$127.87
SG412	Plunger Spring	Bag	10,000/bag	\$572.00	\$63.72

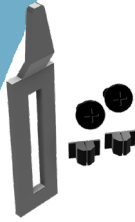
**STRIKES**

HB-1115-7

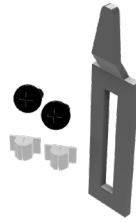

HB-1115-3



HB-1115-9

Part #	Description	UOM	QTY	List Price Bulk
HB-1115-7	Standard Strike Bag	Box	100/box	\$498.00
HB-1115-3	Standard Strike Bag	Box	100/box	\$498.00
HB-1115-9	Standard Strike Bag	Box	100/box	\$498.00

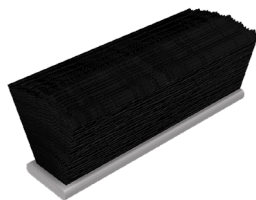
**Woolpile**

WP3XX187X380-F

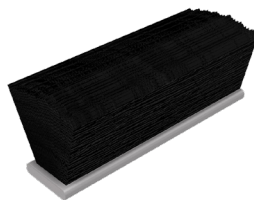

WP7XX187X500-F



WPTF187X250

Part #	Description	Color	Length	UOM	QTY	List Price
WP3XX187X380-F	.380" High Pile	Standard	4,000'	Box	4,000'	\$1,152.80
WP7XX187X500-F	.500" High Woolpile	Standard	1,500'	Roll	1,500'	\$448.80
WPTF187X250	Foam, T-Slot	Natural	1,000'	Box	1,000'	\$1,146.64

**SMOOTH TRIM COIL**





**TRIM COIL**

**24 inch X 50 feet**  
60.96 CM X 15.24 M

PROFESSIONAL GRADE  
ALUMINUM TRIM COIL  
Standard White

AS16X24X50C01B

Part #	Description	Color	Length	UOM	List Price
AS16X24X50C01B	24" X 50' Trim Coil	White	50'	Box	\$560.00

**1-800-949-4174**



**www.RITESCREEEN.com**



**insidesales@ritescreen.com**



**RITESCREEEN**